

Success Story



where

- YiWanJia Supermarket
- Guangzhou, Sihui

what

- Installation of 7 CDUs with Hecu sistema R410A solution and evaluation of benefits
- Hecusistema real energy consumption comparison with ON-OFF system
- "Semi-plugin strategy": condensing unit and cabinets are assembled and tested together by General Fushi

why

- High energy efficiency
- Full connection with cabinets
- Optimal food preservation
- Return on investment analysis

when

- December 2016

who

- CDU and cabinet OEM: General Fushi
- Retailer: YiWanJia

Hecu sistema

Real comparison between different technologies

Partners Carel and General Fushi Refrigeration, a company dealing with the production, sale and installation of refrigeration units, have developed the first Hecu condensing unit on the Chinese market. Now they are installing Hecu sistema in convenience stores and medium-sized supermarkets.

Founded in 1997, General Fushi manufactures more than 12,000 units annually, including cabinets, compressor racks and heat exchangers, covering all applications from super/hypermarkets to convenience stores and cold rooms.

Yiwanjia is a local brand in Guangzhou Zhaoqing city and currently owns 13 stores. The Sihui store was built in December 2016, the sales area is about 3000 m², Hecu sistema was adopted as the preferred solution for the refrigeration system.

The use of SCI BLDC scroll compressors with CAREL DC inverter guarantees higher performance in terms of energy efficiency when compared to other technologies, thanks to the wide range of cooling capacity modulation.

Data collection began in January 2017 with PlantVisor PRO. The operating conditions of the new YiWanJia store were compared against a traditional store running R404A ON-OFF units. Below are the preliminary results of 2 months of comparative analysis:

- 27% average energy saving;
- Higher quality food temperature control;
- Monthly cost savings of 7600¥.

Based on the annual energy saving forecast and cost estimation provided by the partner in the project, the return on investment (ROI) has been estimated to be less than 16 months.

Sales area and system description

The hypermarket is situated near Guangzhou, in southern China. The local climate profile sees average temperatures of around 23°C, with peaks that may exceed 40°C in summer. The store covers a total surface area of 3000 m² and comprises 23 cabinets and 2 cold rooms, divided between low and medium temperature applications. There are a total of 7 Hecu condensing units with a total cooling capacity of 63 kW. The tables below summarises the selling area information.



Map of the store on PlantVisor PRO

Cabinet details

Application	Cooling capacity	Quantity	Type
MT	50.48 kW	15	Cabinet
		1	Cold room
LT	12.53 kW	8	Cabinet
		1	Cold room

Condensing unit details

	CDU	Capacity	Compressor Model	Refrigerant type
BLDC	MT 1	5.70 kW	ANB33	R410A
	MT 2	15.00 kW	ANB66	R410A
	MT 3	13.35 kW	ANB66	R410A
	MT 4	16.40 kW	ANB78	R410A
	LT 1	4.30 kW	ANB42	R410A
	LT 2	4.30 kW	ANB42	R410A
	LT 3	3.95 kW	ANB33	R410A



Multi-deck showcase with MPX PRO controllers

Hecusistema



Hecu sistema configuration

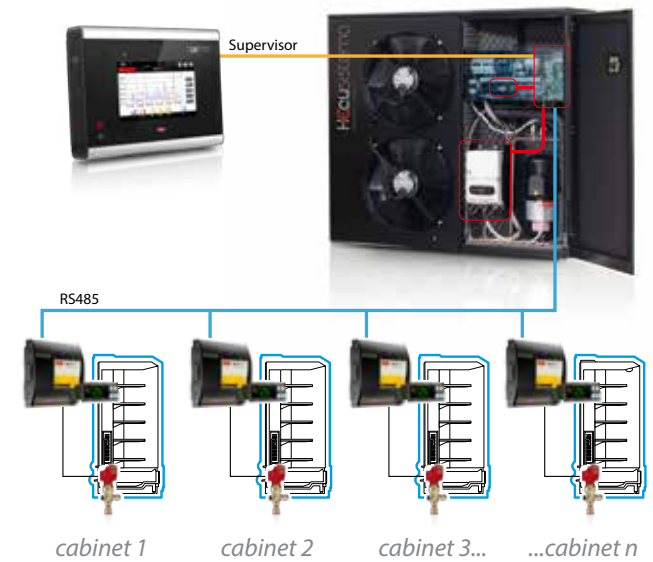

Diagram

Medium temperature

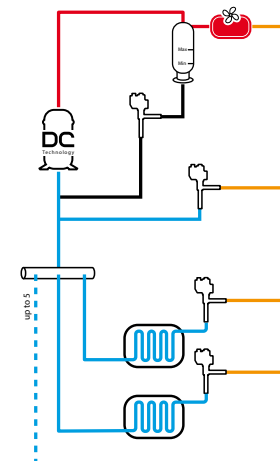

Low temperature

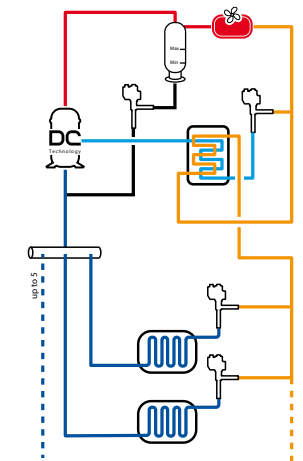

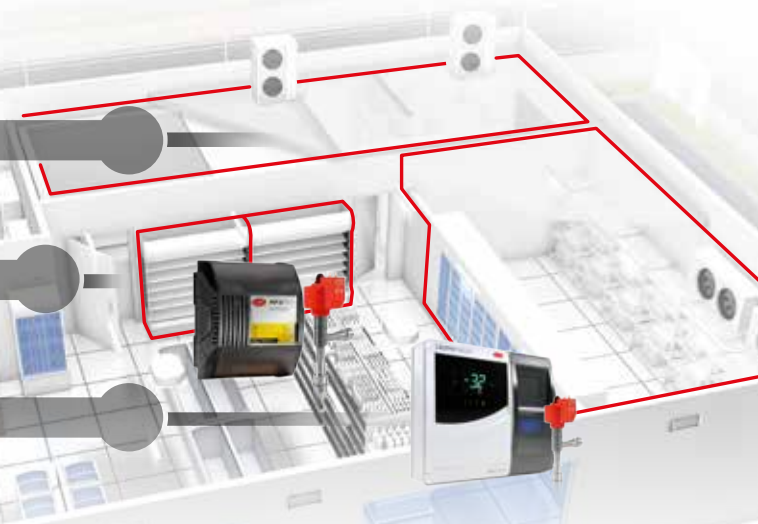

Real capacity modulation for medium-sized supermarkets

Refrigeration systems in small and medium stores typically comprise a limited number of showcases connected to one or more condensing units. Hecu sistema integrates the condensing unit equipped with DC compressor into the refrigerated units inside the store, equipped with electronic expansion valves. Increasing attention to energy efficiency, meaning lower environmental impact and reduced running costs, makes the CAREL solution the perfect response to market needs. The strengths of the proposed solution are:



New frontier in efficiency:

- Lower running costs and fast return on investment
- Wide and real capacity modulation to maximise efficiency at partial load
- Self-optimisation through real time communication with indoor units



Innovation suitable for everyone:

- System solution in compact, fully-integrated equipment
- Intuitive programming and fast commissioning procedure
- Compact dimensions and weight, considerable reduction in Total Cost of Ownership



NO food waste:

- Reliable performance with precise compressor envelope control
- No system down-time for oil return issues with advanced software feature and proper multisplit installation
- Stable product temperature thanks to modulating device and floating setpoint



Always connected:

- Total connection with tERA system via smartphone, tablet and PC
- Performance monitoring, full settings management and periodical reports for each unit
- Benchmarks, dashboards and business intelligence tools within connected installations

General Fushi installation strategy

General Fushi is both the OEM and the installer of the condensing units and cabinets. Hecu condensing units and cabinets with MPX PRO are connected, pre-configured and tested in the factory. This process allows the settings of the complete package to be optimised before installation on site.

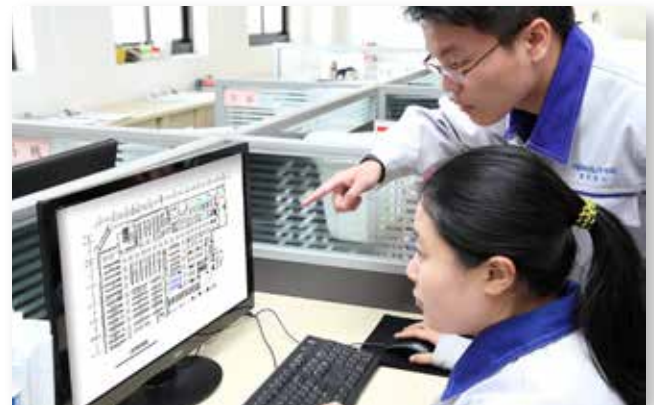

General Fushi developing Team

7 Hecu sistema CDUs were installed in the YiWanJia supermarket and connected together with 23 cabinets and 2 cold rooms in a very short time, thanks to the simplified commissioning procedures and factory pre-configuration.

Advanced modulation features

Serial connection between Hecu and MPX PRO controllers allows real-time knowledge of individual showcase operating conditions, in this way, the condensing unit can adopt advanced energy saving algorithms and at the same time increase the performance of the entire system.

Floating Suction & Compressor speed modulation

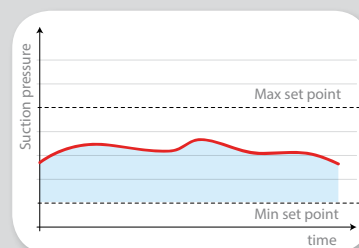

- Real time synchronisation with evaporator request
- Continuous suction pressure set point modulation
- Optimum and stable suction pressure control
- Less compressor on-off cycles

Smooth Lines

- EEV adaptive working conditions
- Continuous superheat set point modulation
- Stable product temperature and less defrosts needed
- Less EEV on-off cycles

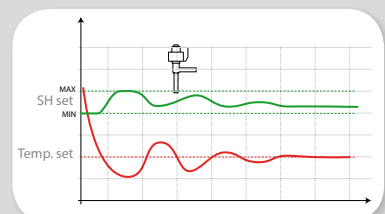

Energy consumption data analysis

The data acquisition process began in January 2017 with PlantVisor PRO. Hecu sistema units are compared with R404A ON-OFF units installed in a similar format supermarket in Shanghai. The average ambient temperature of the two sites revealed that despite Hecu sistema working conditions have been more demanding,

the obtained energy saving is definitely more evident (*).

- 8 weeks' data collected for each technology
- Data acquired on condensing unit energy consumption, indoor and outdoor temperature, indoor and outdoor humidity.

System	Type	Compressor technology	Valve technology	Time period [m-d]	Number of days	Average T	Total energy consumption	Normalised average energy consumption (**)
ON-OFF	MT	scroll ON/OFF	TEV	01/01 - 03/02	61	9 °C	7769 kWh	10.26 kWh/(kW-days)
	LT						4166 kWh	30.35 kWh/(kW-days)
HECU sistema	MT	scroll BLDC	EEV	01/01 - 03/02	61	16 °C	22756 kWh	7.39 kWh/(kW-days)
	LT						17167 kWh	22.46 kWh/(kW-days)

 (*)Worse working conditions for Hecu sistema.

The energy analysers split energy consumption between the MT and LT units. In order to make a real comparison between different installations/technologies and sizes, the energy consumption has been normalised on the installed power capacity and the monitored period (n° of days): [kWh/kW-days]. See last column of the above table (**).

- The energy savings were calculated to be 28% for MT units and 26% for LT units, with a cost saving of 7600¥ per month;
- Data collection is ongoing, in order to extend the benefit calculation across an entire year. The preliminary results are promising and the expectation is to have energy saving exceeding 20% in one year;
- The forecast return on investment (ROI) is less than 16 months.

Results

	HECU sistema vs ON-OFF
Extra capital cost	+20%
Energy saving (2 months)	-27%
Monthly cost saving	7600¥
Return on investment (ROI)	< 16 months



Headquarters ITALY

CAREL INDUSTRIES Hqs.
Via dell'Industria, 11
35020 Brugine - Padova (Italy)
Tel. (+39) 0499 716611
Fax (+39) 0499 716600
carel@carel.com

Sales organization

CAREL Asia Ltd.
www.carel.com

CAREL Australia Pty Ltd.
www.carel.com.au

CAREL Central and Southern Europe
www.carel.com

CAREL Deutschland GmbH
www.carel.de

CAREL Electronic (Suzhou) Co. Ltd.
www.carel-china.com

CAREL France Sas
www.carelfrence.fr

CAREL HVAC/R Korea Ltd
www.carel.com

CAREL Controls Ibérica, S.I.
www.carel.es

CAREL Italy
www.carel.it

CAREL ACR Systems India (Pvt) Ltd.
www.carel.in

CAREL Mexicana S de RL de CV
www.carel.mx

CAREL Middle East DWC LLC
www.carel.com

CAREL Nordic AB
www.carel.com

CAREL Russia LLC
www.carelrussia.com

CAREL Controls South Africa (Pty) Ltd.
www.carelcontrols.co.za

CAREL Sud America Instrumentação
Electronica LTDA
www.carel.com.br

CAREL Thailand
www.carel.co.th

CAREL U.K. LTD
www.careluk.co.uk

CAREL U.S.A. L.L.C.
www.carelusa.com

Affiliates

CAREL Czech & Slovakia
CAREL spol. s.r.o.
www.carel-cz.cz

CAREL Ireland
FarrahVale Controls & Electronics Ltd.
www.carel.com

CAREL Japan Co., Ltd.
www.carel-japan.com

CAREL Turkey
CFM Sogutma ve Otomasyon San. Tic. Ltd.
www.carel.com.tr