

Blast Chiller

Blast chiller controller

CAREL



ENG User manual

→ **LEGGI E CONSERVA
QUESTE ISTRUZIONI** ←
**READ AND SAVE
THESE INSTRUCTIONS**

Integrated Control Solutions & Energy Savings

IMPORTANT



CAREL bases the development of its products on decades of experience in HVAC, on the continuous investments in technological innovations to products, procedures and strict quality processes with in-circuit and functional testing on 100% of its products, and on the most innovative production technology available on the market. CAREL and its subsidiaries nonetheless cannot guarantee that all the aspects of the product and the software included with the product respond to the requirements of the final application, despite the product being developed according to start-of-the-art techniques. The customer (manufacturer, developer or installer of the final equipment) accepts all liability and risk relating to the configuration of the product in order to reach the expected results in relation to the specific final installation and/or equipment. CAREL may, based on specific agreements, act as a consultant for the positive commissioning of the final unit/application, however in no case does it accept liability for the correct operation of the final equipment/system.

The CAREL product is a state-of-the-art product, whose operation is specified in the technical documentation supplied with the product or can be downloaded, even prior to purchase, from the website www.carel.com.

Each CAREL product, in relation to its advanced level of technology, requires setup / configuration / programming / commissioning to be able to operate in the best possible way for the specific application. The failure to complete such operations, which are required/indicated in the user manual, may cause the final product to malfunction; CAREL accepts no liability in such cases.

Only qualified personnel may install or carry out technical service on the product. The customer must only use the product in the manner described in the documentation relating to the product.

In addition to observing any further warnings described in this manual, the following warnings must be heeded for all CAREL products:

- Prevent the electronic circuits from getting wet. Rain, humidity and all types of liquids or condensate contain corrosive minerals that may damage the electronic circuits. In any case, the product should be used or stored in environments that comply with the temperature and humidity limits specified in the manual.
- Do not install the device in particularly hot environments. Too high temperatures may reduce the life of electronic devices, damage them and deform or melt the plastic parts. In any case, the product should be used or stored in environments that comply with the temperature and humidity limits specified in the manual.
- Do not attempt to open the device in any way other than described in the manual.
- Do not drop, hit or shake the device, as the internal circuits and mechanisms may be irreparably damaged.
- Do not use corrosive chemicals, solvents or aggressive detergents to clean the device.
- Do not use the product for applications other than those specified in the technical manual.

All of the above suggestions likewise apply to the controllers, serial boards, programming keys or any other accessory in the CAREL product portfolio.

CAREL adopts a policy of continual development. Consequently, CAREL reserves the right to make changes and improvements to any product described in this document without prior warning.

The technical specifications shown in the manual may be changed without prior warning.

The liability of CAREL in relation to its products is specified in the CAREL general contract conditions, available on the website www.carel.com and/or by specific agreements with customers; specifically, to the extent where allowed by applicable legislation, in no case will CAREL, its employees or subsidiaries be liable for any lost earnings or sales, losses of data and information, costs of replacement goods or services, damage to things or people, downtime or any direct, indirect, incidental, actual, punitive, exemplary, special or

consequential damage of any kind whatsoever, whether contractual, extra-contractual or due to negligence, or any other liabilities deriving from the installation, use or impossibility to use the product, even if CAREL or its subsidiaries are warned of the possibility of such damage.

DISPOSAL

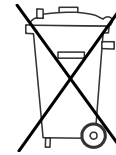

INFORMATION FOR USERS ON THE CORRECT HANDLING OF WASTE ELECTRICAL AND ELECTRONIC EQUIPMENT (WEEE)

In reference to European Union directive 2002/96/EC issued on 27 January 2003 and the related national legislation, please note that:

- WEEE cannot be disposed of as municipal waste and such waste must be collected and disposed of separately;
- the public or private waste collection systems defined by local legislation must be used. In addition, the equipment can be returned to the distributor at the end of its working life when buying new equipment;
- the equipment may contain hazardous substances: the improper use or incorrect disposal of such may have negative effects on human health and on the environment;
- the symbol (crossed-out wheeled bin) shown on the product or on the packaging and on the instruction sheet indicates that the equipment has been introduced onto the market after 13 August 2005 and that it must be disposed of separately;
- in the event of illegal disposal of electrical and electronic waste, the penalties are specified by local waste disposal legislation

KEY TO THE ICONS



NOTE: to bring attention to a very important subject; in particular, regarding the practical use of the various functions of the product.













IMPORTANT: to bring critical issues regarding the use of the Blast Chiller to the attention of the user.



TUTORIAL: some simple examples to accompany the user in configuring the most common settings.

Contents

1	INTRODUCTION.....	7
1.1	Main features.....	7
1.2	Models and features.....	7
1.3	Components and accessories.....	7
1.4	Description of the pCO ³ Small board.....	7
1.5	Description of the pCO ^{XS} board.....	10
1.6	Product probe.....	13
2	INSTALLATION.....	14
2.1	General installation instructions.....	14
2.2	Power supply.....	14
2.3	Connecting the analogue inputs.....	14
2.4	Connecting the digital inputs.....	16
2.5	Connecting the analogue outputs.....	16
2.6	Connecting the digital outputs.....	17
3	USER INTERFACE.....	18
3.1	Graphic terminals.....	18
3.2	Navigation buttons.....	19
4	FUNCTIONS.....	20
4.1	Chill and freeze cycles.....	20
4.2	Temperature control.....	22
4.3	Compressor management.....	22
4.4	Fan management.....	23
4.5	Defrost.....	25
4.6	HACCP (Hazard Analysis and Critical Control Point).....	26
4.7	Lights.....	27
4.8	Auxiliary output.....	27
4.9	Antifreeze.....	27
4.10	ON/OFF.....	27
4.11	Sterilisation.....	28
4.12	Heat probe.....	28
5	DESCRIPTION OF THE MENUS.....	29
5.1	 On/Off.....	30
5.2	 Cycle.....	30
5.3	 Conservation.....	30
5.4	 Sterilisation.....	30
5.5	 Heat probe.....	31
5.6	 Settings.....	31
5.7	 Maintenance.....	31
5.8	 Clock.....	32
5.9	 Data log.....	32
5.10	 Lock keypad.....	32
6	TABLE OF PARAMETERS.....	33
7	TABLE OF ALARMS.....	41
7.1	High and low temperature alarm.....	41
8	TABLE OF VARIABLES SENT TO THE SUPERVISOR.....	42
9	CONFIGURATIONS.....	45

1 INTRODUCTION

1.1 Main features

Blast Chiller is a complete range of controllers and user terminals for managing the blast chilling, blast freezing and conservation of foodstuffs, in compliance with the relevant standards in force. Additional features include blast chill cycles that are completely customisable by the user, smart defrosts and optimum time management using the built-in clock.

Blast Chiller is based on the pCO series programmable platform (one version on the pCO³ Small and one on the pCO^{XS}) and features a graphic interface (pGD1 series) and a simple and user-friendly menu for navigation through three levels of access, protected by password. Unlike traditional controllers, Blast Chiller guarantees a reduction in electricity consumption, thus bringing cost reductions and helping to protect the environment.

1.2 Models and features

platform	pCO ³ Small		pCO ^{XS}	
code	BC00SMW000	BC00SPW000	BC00XMW000	BC00XPW000
terminal	rear panel assembly with membrane keypad	panel installation with plastic faceplate	rear panel assembly with membrane keypad	panel installation with plastic faceplate
analogue inputs	up to 5 (NTC, up to 2 pt1000)	up to 5 (NTC, up to 2 pt1000)	up to 4 (NTC)	up to 4 (NTC)
digital inputs	up to 8	up to 8	up to 6	up to 6
digital outputs	up to 8	up to 8	up to 5	up to 5
analogue outputs	up to 4	up to 4	up to 3	up to 3
standard cycles	X	X	X	X
custom cycles	X	X	X	X
conservation phase	X	X	X	X
graphic display	X	X	X	X
languages	5*	5*	5*	5*
real time clock	X	X	X	X
HACCP report	X	X	X	X
programming with key	X	X	X	X
supervision	X	X	X	X
printer	X	X	X	X
buzzer		X		X
RS485 option	X	X	X	X
certification	CE, UL	CE, UL	CE, UL	CE, UL

*languages available: ITA, ENG, FRA, ESP, DEU.

1.3 Components and accessories

description	code
Blast Chiller - pCO ^{XS} with display, panel mounting with plastic faceplate	BC00XPW000
Blast Chiller - pCO ^{XS} with display, rear panel assembly with membrane keypad	BC00XMW000
Blast Chiller - pCO ³ with display, panel mounting with plastic faceplate	BC00SPW000
Blast Chiller - pCO ³ with display, rear panel assembly with membrane keypad	BC00SMW000
telephone connection cable display-panel with plastic faceplate	S90CONN00* (see paragraph 3.1.1)
NTC piercing probe, 6 m cable, range -50T110 °C	NTCINF0600
NTC piercing probe, 90° with handle, 6 m cable, range -50T110 °C	NTCINF0610
NTC piercing probe, 90° with handle, 3 m cable, range -50T110 °C	NTCINF0340
PT1000 piercing probe, 90° with handle, 6 m cable, range -50T200 °C	PT1INF0340
printer kit	BCOPZPRN00

1.4 Description of the pCO³ Small board

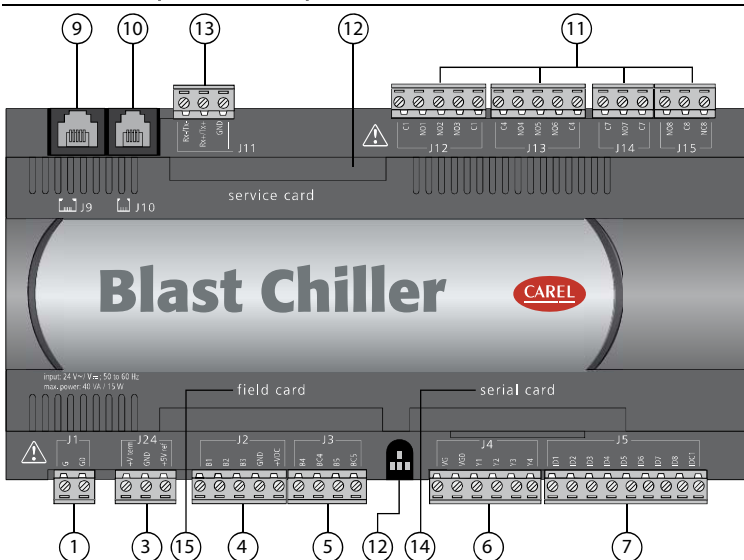

Key

1	power supply connector [G (+), G0 (-)];
2	yellow power LED and 3 status LEDs;
3	additional power supply for the terminal and 0 to 5 V ratiometric probes;
4	universal analogue inputs: NTC, 0 to 1 V, 0 to 5 V - ratiometric, 0 to 10 V, 0 to 20 mA, 4 to 20 mA;
5	passive analogue inputs: NTC, PT1000, ON/OFF;
6	0 to 10 V analogue outputs;
7	24 Vac/Vdc digital inputs;
8	230 Vac or 24 Vac/Vdc digital inputs;
9	connector for the display panel (external with direct signals);
10	connector for all standard pCO series terminals and for downloading the application program;
11	relay digital outputs;
12	connector for connection to the I/O expansion board;
13	pLAN network connector;
14	cover for inserting the supervisor and telemaintenance option;
15	cover for inserting the field card option;

1.4.1 Meaning of the inputs/outputs on the pCO³ Small board

Connector	Signal	Description
J1-1	G	+24 Vdc or 24 Vac power supply
J1-2	G0	power supply reference
J2-1	B1	universal analogue input 1 (NTC, 0 to 1 V, 0 to 10 V, 0 to 20 mA, 4 to 20 mA)
J2-2	B2	universal analogue input 2 (NTC, 0 to 1 V, 0 to 10 V, 0 to 20 mA, 4 to 20 mA)
J2-3	B3	universal analogue input 3 (NTC, 0 to 1 V, 0 to 10 V, 0 to 20 mA, 4 to 20 mA)
J2-4	GND	common for analogue inputs
J2-5	+VDC	21 Vdc power supply for active probes (maximum current 200 mA)
J3-1	B4	passive analogue input 4 (NTC, PT1000, ON/OFF)
J3-2	BC4	common for analogue input 4
J3-3	B5	passive analogue input 5 (NTC, PT1000, ON/OFF)
J3-4	BC5	common for analogue input 5
J4-1	VG	power to optically-isolated analogue output, 24 Vac/Vdc
J4-2	VG0	power to optically-isolated analogue output, 0 Vac/Vdc
J4-3	Y1	analogue output no. 1, 0 to 10 V
J4-4	Y2	analogue output no. 2, 0 to 10 V
J4-5	Y3	analogue output no. 3, 0 to 10 V
J4-6	Y4	analogue output no. 4, 0 to 10 V
J5-1	ID1	digital input no. 1, 24 Vac/Vdc
J5-2	ID2	digital input no. 2, 24 Vac/Vdc
J5-3	ID3	digital input no. 3, 24 Vac/Vdc
J5-4	ID4	digital input no. 4, 24 Vac/Vdc
J5-5	ID5	digital input no. 5, 24 Vac/Vdc
J5-6	ID6	digital input no. 6, 24 Vac/Vdc
J5-7	ID7	digital input no. 7, 24 Vac/Vdc
J5-8	ID8	digital input no. 8, 24 Vac/Vdc
J5-9	IDC1	common for digital inputs from 1 to 8 (negative pole for DC power supply)
J9		8-pin telephone connector for connection to a display panel
J10		6-pin telephone connector for connection to the standard user terminal
J11-1	RX-/TX-	RX-/TX- connector for connection, over RS485, to the pLAN network
J11-2	RX+/TX+	RX+/TX+ connector for connection, over RS485, to the pLAN network
J11-3	GND	GND connector for connection, over RS485, to the pLAN network
J12-1	C1	common relay: 1, 2, 3
J12-2	NO1	normally open contact, relay no. 1
J12-3	NO2	normally open contact, relay no. 2
J12-4	NO3	normally open contact, relay no. 3
J12-5	C1	common relay: 1, 2, 3
J13-1	C4	common relay: 4, 5, 6
J13-2	NO4	normally open contact, relay no. 4
J13-3	NO5	normally open contact, relay no. 5
J13-4	NO6	normally open contact, relay no. 6
J13-5	C4	common relay: 4, 5, 6
J14-1	C7	common relay no. 7
J14-2	NO7	normally open contact, relay no. 7
J14-3	C7	common relay no. 7
J15-1	NO8	normally open contact, relay no. 8
J15-2	C8	common relay no. 8
J15-3	NC8	normally closed contact relay no. 8
J24-1	+V term	power supply to additional Aria terminal
J24-2	GND	power supply common
J24-3	+5 Vref	power supply for 0/5 V ratiometric probes

1.4.2 Technical specifications of the pCO³ Small board

Analogue inputs					
Analogue conversion	10-bit A/D converter embedded in CPU				
Maximum number	5				
Type	<p><i>Universal</i>: 6 (inputs B1, B2, B3, B6, B7, B8) -CAREL NTC (-50T90°C; R/T 10kΩ±1% at 25°C) or HT NTC (0T150°C) -Voltage: 0 to 1 Vdc, 0 to 5 Vdc ratiometric or 0 to 10 Vdc -Current: 0 to 20 mA or 4 to 20 mA. Input resistance: 100Ω Can be selected via software.</p> <p><i>Passive</i>: 4 (inputs B4, B5, B9, B10) -CAREL NTC (-50T90°C; R/T 10kΩ ±1% at 25°C), -PT1000 (-100T200°C; R/T 1kΩ to 0°C) or digital input from voltage-free contact Can be selected via software.</p>				
Minimum normally-open voltage-free digital input detection time	<table border="1"> <tr> <td><i>Normally open</i> (open-closed-open)</td> <td>250ms</td> </tr> <tr> <td><i>Normally closed</i> (closed-open-closed)</td> <td>250ms</td> </tr> </table>	<i>Normally open</i> (open-closed-open)	250ms	<i>Normally closed</i> (closed-open-closed)	250ms
<i>Normally open</i> (open-closed-open)	250ms				
<i>Normally closed</i> (closed-open-closed)	250ms				
NTC input precision	± 0.5°C				
PT1000 input precision	± 1°C				
0-1V input precision	± 3mV				
0-10V input precision	± 30mV				

0-5V input precision	± 15mV
0-20 mA input precision	± 0.06 mA

⚠ Important: the 21Vdc available at the +Vdc terminal (J2) can be used to power any active probes. The maximum current is 150 mA, thermally protected against short-circuits. To supply the 0 to 5 V ratiometric probes, use the 5V available at terminal +5Vref (J24). The maximum current is 60 mA.

Digital inputs

Type	optically-isolated		
Maximum number		no. of optically-isolated inputs at 24 Vac 50/60 Hz or 24Vdc	Total
		8	8
Minimum digital input impulse detection time	Normally open (open-closed-open)		200 ms
	Normally closed (closed-open-closed)		400 ms
Power supply to the inputs	External	230 Vac or 24 Vac (50/60 Hz) 24Vdc	+10/-15% +10/-20%
Classification of the measurement circuits (IEC EN 61010-1)	Category 1 24 Vac/Vdc Category 2 230 Vac		

Analogue outputs

Type	optically-isolated	
Maximum number	4 x 0 to 10 Vdc outputs (Y1-Y4)	SMALL
Power supply	external	24 Vac/Vdc
Precision	outputs Y1-Y4	± 2% of full scale
	outputs Y5-Y6	-2/+5% of full scale
Resolution	8 bit	
Settling time	outputs Y1-Y4	2s
	outputs Y5-Y6	2s or 15s selected via software
Maximum load	1 kΩ (10mA)	

Digital outputs

Insulation distance	The outputs can be divided into groups. Between groups (cells in the table) there is double insulation and consequently these may have different voltages. There is also double insulation between each terminal of the digital outputs and the rest of the controller. The relays belonging to the same group (individual cell in the table) have basic insulation and therefore must have the same power supply (24 Vac or 230 Vac).		
Makeup of the groups	Reference for the relays with the same insulation		
		Group 1 1 to 7	Group 2 8
Type of relay	Type A		Type A
Number of changeover contacts	1 (output 8);		
Switchable power	Type A relay	Relay ratings	SPDT, 2000VA, 250Vac, 8 A resistive
		PCO ³ approval	UL873 2.5 A resistive, 2 A FLA, 12 A LRA, 250Vac, C300 pilot duty (30,000 cycles) EN 60730-1 2 A resistive, 2 A inductive, cosφ=0.6, 2(2)A (100,000 cycles)
Max number of SSR outputs	1 (output 7);		

⚠ Important: the groups that the digital outputs are divided into have two common pole terminals to simplify wiring; make sure that the current running through the common terminals does not exceed the rated current of an individual terminal, that is, 8 A.

1.4.3 Mechanical specifications of the pCO³ Small board

Mechanical dimensions:	13 DIN modules	110 x 227.5 x 60mm
Plastic case:		
Assembly	Fitted on DIN rail as per DIN 43880 and IEC EN 50022	
Material	Technopolymer	
Flame retardance	V0 (UL94) and 960°C (IEC 695)	
Ball pressure test	125°C	
Resistance to creeping current	≥ 250 V	
Colour	Grey RAL7035	

1.4.4 Other specifications of the pCO³ Small board

Operating conditions	-25T70°C, 90% rH non-condensing
Storage conditions	-40T70°C, 90% rH non-condensing
Index of protection	IP20, IP40 on the front panel only
Environmental pollution	2
Class according to protection against electric shock	to be integrated into Class 1 and/or 2 appliances
PTI of the insulating materials	250 V
Period of stress across the insulating parts	long
Type of action	1C
Type of disconnection or microswitching	microswitching, for all relay outputs
Category of resistance to heat and fire	Category D
Immunity against voltage surges	Category 1
Ageing characteristics (operating hours)	80,000

No. of automatic operating cycles	100,000 (EN 60730-1); 30,000 (UL 873)
Software class and structure	Class A
Category of immunity to voltage surges (IEC EN 61000-4-5)	Category 2

1.4.5 Electrical specifications of the pCO³ Small board

Power supply	24 Vac +10/-15% 50/60 Hz and 28 to 36 Vdc +10/-20%
Maximum current with terminal connected	40 VA (Vac) / 15 W (Vdc)
Type of insulation of the power supply from the rest of the cont.	-
Terminal block	with male/female plug-in connectors (250Vac max, 8 A max)
Cable cross-section	min 0.5 mm ² – max 2.5 mm ²
CPU	H8S2320, 16 bit, 24 MHz
Program memory (FLASH MEMORY)	2+2 MB (Dual Bank) x 16 bits
Data memory (RAM)	512 KB x 16 bits
T buffer memory (EEPROM MEMORY)	13 KB
P parameter memory (EEPROM MEMORY)	32 KB not visible from the pLAN network
Working cycle duration (application of average complexity)	0.2 s
Clock with battery	standard

1.4.6 Dimensions of the pCO³ Small

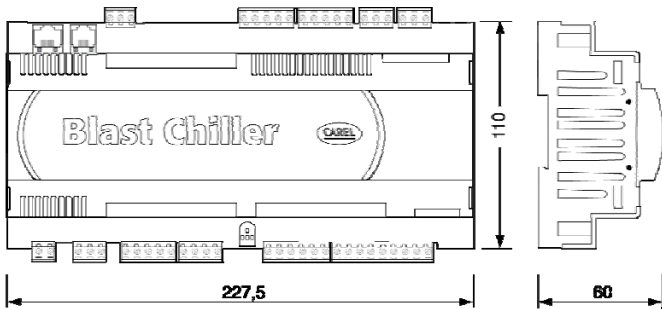

Product certification:

IEC EN 50155 standard: "Railway applications • Electronic equipment used on rolling stock";
 UL 873 and C22.2 No. 24-93: "Temperature-Indicating and -Regulating Equipment";
 EC regulations 37/2005 of 12 January 2005; in particular, if the electronic controller is fitted with standard Carel NTC sensors, it is compliant with standard EN13485 on "Thermometers for measuring the air temperature in applications on units for the conservation and sale of refrigerated, frozen and deep-frozen food and ice cream".

1.5 Description of the pCO^{XS} board

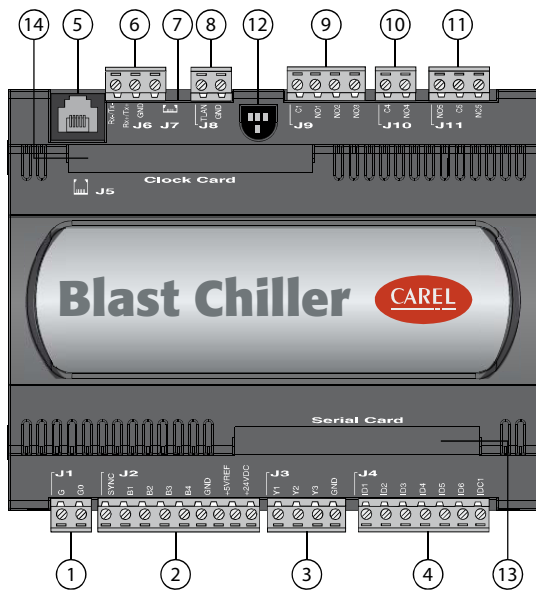

Key

1	Power supply connector [G (+), G0 (-)] 24 Vac or 20/60 Vdc; Input (24 Vac) for phase control and NTC, 0/1 V, 0/5 V, 0/20 mA, 4/20 mA analogue inputs, +5Vref for power supply to 5V ratiometric probe and +24Vdc power to active probes;
2	0 to 10 V analogue outputs and PWM phase control output;
3	Digital inputs with voltage-free contact;
4	Connector for all standard pCO* series terminals and for downloading the application program;
5	pLAN network connector;
6	tLAN terminal connector;
7	tLAN network or MP-Bus connector;
8	Relay digital outputs with one common;
9	Relay/SSR digital output;
10	Digital output for alarm relay with changeover contact/SSR;
11	Yellow power LED and 3 status LEDs
12	Cover for inserting the supervisor and telemaintenance option
13	Cover for inserting the clock board;

1.5.1 Meaning of the inputs/outputs on the pCO^{XS} board

connector	signal	description
J1-1	G	24 Vac or 20/60 Vdc power supply
J1-2	G0	power supply reference
J2-1	SYNC	synchronicity input for phase control (G0 is the reference)
J2-2	B1	universal analogue input 1 (NTC, 0/1V, 0/5 V, 0/20 mA, 4/20 mA)
J2-3	B2	universal analogue input 2 (NTC, 0/1V, 0/5 V, 0/20 mA, 4/20 mA)
J2-4	B3	universal analogue input 3 (NTC, 0/5 V)
J2-5	B4	universal analogue input 4 (NTC, 0/5 V)
J2-6	GND	reference for analogue inputs
J2-7	+5VREF	power supply for 0/5 V ratiometric probes
J2-8	+24VDC	power supply for 24 Vdc active probes
J3-1	Y1	analogue output no. 1, 0/10 V
J3-2	Y2	analogue output no. 2, 0/10 V
J3-3	Y3	analogue output no. 3, PWM (for phase cutting speed controllers)
J3-4	GND	reference for analogue output

J4-1	ID1	digital input no. 1
J4-2	ID2	digital input no. 2
J4-3	ID3	digital input no. 3
J4-4	ID4	digital input no. 4
J4-5	ID5	digital input no. 5
J4-6	ID6	digital input no. 6
J4-7	IDC1	common for digital inputs from 1 to 6
J5		6-pin telephone connector for connection to the standard user terminal
J6-1	RX-/TX-	RX-/TX- connector for connection, over RS485, to the pLAN network
J6-2	RX+/TX+	RX+/TX+ connector for connection, over RS485, to the pLAN network
J6-3	GND	reference for connection, over RS485, to the pLAN network
J7		tLAN terminal connector
J8-1	TLAN	tLAN network connector
J8-2	GND	reference for connection to the tLAN network
J9-1	C1	common relay: 1, 2, 3
J9-2	NO1	normally open contact, relay no. 1
J9-3	NO2	normally open contact, relay no. 2
J9-4	NO3	normally open contact, relay no. 3
J10-1	C4	common relay: 4
J10-2	NO4	normally open contact, relay no. 4
J11-1	NO5	normally open contact, relay no. 5
J11-2	C5	common relay: 5
J11-3	NC5	normally closed contact relay no. 5

1.5.2 Technical specifications of the pCO^{AS} board

Analogue inputs

Analogue conversion	10-bit A/D converter embedded in CPU
Maximum number	4
Type	<i>Universal: 2 (inputs B1,B2)</i> -CAREL NTC (-50T90°C; R/T 10kΩ±1% at 25°C) -Voltage 0 to 1 Vdc, 0 to 5 Vdc ratiometric; -Current 0 to 20 mA or 4 to 20 mA. Input resistance: 100Ω Can be selected via software <i>Universal: 2 (inputs B3,B4)</i> -CAREL NTC (-50T90°C; R/T 10kΩ±1% at 25°C) -Voltage 0 to 5 Vdc ratiometric Can be selected via software
Time constant for each input	1 s
NTC input precision	± 0.5°C
0-1V input precision	± 3mV
0-5V input precision	± 15mV
0-20 mA input precision	± 0.06 mA

 **Important:** the 24Vdc available at the +24Vdc terminal (J2) can be used to power any active probes. The maximum current is 80 mA, thermally protected against short-circuits. To supply the 0 to 5 V ratiometric probes, use the 5V available at terminal +5Vref (J2). The maximum current is 60 mA.

Digital inputs

Type	Voltage-free contact, not optically-isolated		
Maximum number	no. of optically-isolated inputs at 24 Vac 50/60 Hz or 24Vdc		Total
	6		6
Minimum digital input impulse detection time	<i>Normally open</i> (open-closed-open)	150 ms	
	<i>Normally closed</i> (closed-open-closed)	400 ms	
Power supply to the inputs	internal		

Analogue outputs

Type	Not optically-isolated		
Maximum number	2 x 0 to 10 Vdc outputs (Y1 and Y2) and 1 PWM output (Y3) with 5V pulse of programmable duration		
Power supply	internal		
Precision	outputs Y1-Y2		± 3% of full scale
Resolution	8 bit		
Settling time	outputs Y1-Y2		2s
Maximum load	1 kΩ (10mA) for 0 to 10 Vdc and 470Ω (10mA) for PWM		

 **Note:** the synchronicity for the PWM phase control output is taken from SYNC and G0. The PWM output (Y3) can become a pulse modulation input (pulse duration proportional to the analogue value) by setting the software. The PWM may be in synchronicity with the SYNC signal or have a fixed cycle of 2 ms

Digital outputs

Insulation distance	The outputs can be divided into groups. Between groups (cells in the table) there is double insulation and consequently these may have different voltages. There is also double insulation between each terminal of the digital outputs and the rest of the controller. The relays belonging to the same group (individual cell in the table) have basic insulation and therefore can have the same power supply (24 Vac or 230 Vac).			
Makeup of the groups	Version	Reference for the relays with the same insulation		
	-	Group 1	Group 2	Group 3
		1 to 3	4	5

	Type of relay	Type A	Type A	Type A
Number of changeover contacts	1: output 5			
Switchable power	Type A relay	Relay ratings	SPDT, 2000VA, 250Vac, 8 A resistive	
		PCO ^{XS} approval	UL873	2.5 A resistive, 2 A FLA, 12 A LRA, 250Vac, (30,000 cycles)
Maximum number of SSR outputs	2: outputs 4 and 5; Electrical specifications: working voltage 24 Vac/Vdc, maximum switchable power 10 Watts			

! **Important:** the groups that the digital outputs are divided into have two common pole terminals to simplify wiring. Make sure that the current running through the common terminals does not exceed the rated current of an individual terminal, that is, 8A.

1.5.3 Mechanical specifications of the pCO^{XS} board

Mechanical dimensions	13 DIN modules	110 x 227.5 x 60mm
Plastic case		
Assembly	Fitted on DIN rail as per DIN 43880 and IEC EN 50022	
Material	technopolymer	
Flame retardance	V0 (UL94) and 960°C (IEC 695)	
Ball pressure test	125°C	
Resistance to creeping current	± 250 V	
Colour	Grey RAL7035	

1.5.4 Other specifications of the pCO^{XS} board

Operating conditions	-10T60°C, 90% rH non-condensing (standard vers.) -25T70°C, 90% rH non-condensing (extended range vers.)
Storage conditions	-20T70°C, 90% rH non-condensing (standard vers.) -40T70°C, 90% rH non-condensing (extended range vers.)
Index of protection	IP20, IP40 on the front panel only
Environmental pollution	2
Class according to protection against electric shock	to be integrated into Class 1 and/or 2 appliances
PTI of the insulating materials	250 V
Period of stress across the insulating parts	long
Type of action	1C
Type of disconnection or microswitching	microswitching, for all relay outputs
Category of resistance to heat and fire	Category D
Immunity against voltage surges	Category 1
Ageing characteristics (operating hours)	80,000
No. of automatic operating cycles	100,000 (EN 60730-1); 30,000 (UL 873)
Software class and structure	Class A
Category of immunity to voltage surges (IEC EN 61000-4-5)	Category 2

1.5.5 Electrical specifications of the pCO^{XS} board

Power supply	24 Vac +10/-15% 50/60 Hz and 24...48Vdc +10/-20%
Maximum current with terminal connected	P=8W
Type of insulation of the power supply by the rest of the contr.	functional
Terminal block	with male/female plug-in connectors (250Vac max, 8 A max)
Cable cross-section	min 0.5 mm ² – max 2.5 mm ²
CPU	H8S2320, 16 bit, 24 MHz
Program memory (FLASH MEMORY)	1 MB x 16 bit (expandable up to 1+1MB Dual Bank)
Data memory (RAM)	128 KB x 8 bit (expandable up to 512 KB)
T buffer memory (FLASH MEMORY)	4 KB x 16 bit
P parameters memory (EEPROM MEMORY)	32 KB not visible from the pLAN network
Working cycle duration (application of average complexity)	0.3 s
Clock with battery	Optional

1.5.6 Dimensions of the pCO^{XS}

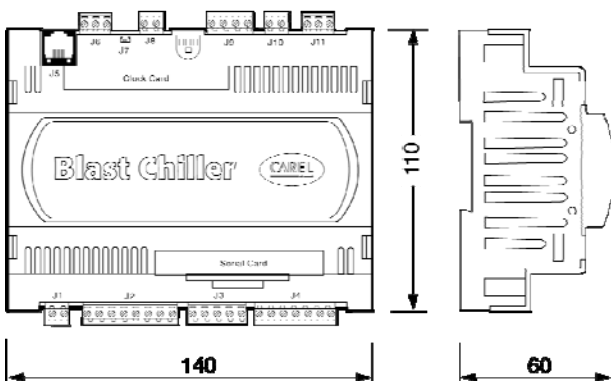

Product certification:

IEC EN 50155 standard: "Railway applications • Electronic equipment used on rolling stock";
 UL 873 and C22.2 No. 24-93: "Temperature-Indicating and -Regulating Equipment";
 EC regulations 37/2005 of 12 January 2005; in particular, if the electronic controller is fitted with standard Carel NTC sensors, it is compliant with standard EN13485 on "Thermometers for measuring the air temperature in applications on units for the conservation and sale of refrigerated, frozen and deep-frozen food and ice cream".

1.6 Product probe

Blast Chiller can be fitted with the following probes for specific uses:

1.6.1 Piercing probe without handle

NTC probe (code NTCINF0600).



1.6.2 Piercing probe with handle

NTC probe (code NTCINF0610), NTC probe with heater (NTCINF0340) and PT1000 probe with heater (PT1INF0340).



2 INSTALLATION

2.1 General installation instructions

2.1.1 Installation procedure

Environmental conditions

Avoid assembling the pCO and the terminal in environments with the following characteristics:

- temperature and humidity that do not conform to the rated operating data of the product;
- strong vibrations or knocks;
- exposure to aggressive and polluting atmospheres (e.g.: sulphur and ammonia fumes, saline mist, smoke) so as to avoid corrosion and/or oxidation;
- strong magnetic and/or radio frequency interference (there avoid installing the units near transmitting antennae);
- exposure of the pCO to direct sunlight and to the elements in general;
- large and rapid fluctuations in the room temperature;
- environments containing explosives or mixes of flammable gases;
- exposure to dust (formation of corrosive patina with possible oxidation and reduction of insulation).

Positioning the instrument inside the panel

The position of the instrument in the electrical cabinet must be chosen so as to guarantee correct physical separation of the instrument from the power components (solenoids, contactors, actuators, inverters, ...) and the connected cables. Proximity to such devices/cables may create random malfunctions that are not immediately evident.

The structure of the panel must allow the correct flow of cooling air.

2.1.2 Wiring procedure

When laying the wiring, "physically" separate the power part from the control part. The proximity of these two sets of wires will, in most cases, cause problems of induced disturbance or, over time, malfunctions or damage to the components. The ideal solution is to house these two circuits in two separate cabinets. Sometimes this is not possible, and therefore the power part and the control part must be installed inside the same panel. For the control signals, it is recommended to use shielded cables with twisted wires. If the control cables have to cross over the power cables, the intersections must be as near as possible to 90 degrees, always avoiding running the control cables parallel to the power cables.

- Use cable ends suitable for the corresponding terminals. Loosen each screw and insert the cable ends, then tighten the screws. When the operation is completed, slightly tug the cables to check they are sufficiently tight;
- separate as much as possible the sensor signal, digital input and serial line cables from the cables carrying inductive loads and power cables to avoid possible electromagnetic disturbance. Never insert power cables (including the electrical cables) and probe signal cables in the same conduits. Do not install the sensor cables in the immediate vicinity of power devices (contactors, circuit breakers or similar);
- reduce the path of the sensor cables as much as possible, and avoid spiral paths that enclose power devices;
- power supplies other than those specified seriously damage the system;
- a Class 2 safety transformer, rating 50 VA, must be used in the installation to supply just one pCO controller;
- the power supply to the pCO controller and terminal (or pCO controllers and terminals) should be separated from the power supply to the other electrical devices (contactors and other electromechanical components) inside the electrical panel;
- if the power transformer secondary is earthed, check that the earth wire corresponds to the wire that runs to the controller and enters terminal G0. This applies to all the devices connected to the pCO;
- a yellow LED indicates that power is connected to the pCO.

- avoid touching or nearly touching the electronic components fitted on the boards to avoid electrostatic discharges (extremely damaging) from the operator to the components;
- if the power transformer secondary is earthed, check that the earth wire corresponds to the wire that runs to the controller and enters terminal G0; this applies to all the devices connected to the pCO;
- do not secure the cables to the terminals by pressing the screwdriver with excessive force, to avoid damaging the pCO;
- for applications subject to considerable vibrations (1.5 mm pk-pk 10/55 Hz), secure the cables connected to the pCO around 3 cm from the connectors using clamps;
- if the product is installed in industrial environments (application of the EN 61000-6-2 standard) the length of the connections must be less than 30 m;
- all the very low voltage connections (analogue and 24 Vac/Vdc digital inputs, analogue outputs, serial bus connections, power supplies) must have reinforced or double insulation from the mains network;
- in residential environments, the connection cable between the pCO and the terminal must be shielded;
- there is no limit to the number of cables that can be connected to an individual terminal. The only limitation concerns the maximum current crossing each terminal: this must not exceed 8 A;
- the maximum cross-section of the cable that connected to a terminal is 2.5 sq.m (12 AWG);
- the maximum value of the twisting torque to tighten the screw on the terminal (torque tightening) is 0.6 Nm;



Important:

- Installation must be performed according to the standards and legislation in force in the country where the device is used;
- for safety reasons the equipment must be housed inside an electrical panel, so that the only accessible part is the display and the keypad;
- in the event of malfunctions, do not attempt to repair the device, but rather contact the CAREL service centre;
- the connector kit also contains the stick-on labels.

2.1.3 Anchoring the pCO

The pCO is installed on a DIN rail. To fasten the unit to the DIN rail, press it lightly against the rail. The rear tabs will click into place, locking the unit to the rail. Removing the unit is just as simple, using a screwdriver through the release slot to lever and lift the tabs. The tabs are kept in the locked position by springs.

2.2 Power supply

Power supply to the pCO ³ (controller with terminal connected)	28 to 36 Vdc +10/-20% or 24 Vac +10/-15% 50 to 60 Hz;
	Maximum current P= 15 W (Vdc power supply). P=40 VA (Vac)
Power supply to the pCO ⁵	20/60 Vdc or 24 Vac ± 15% 50 to 60 Hz;
	Maximum current P= 6.1 W (Vdc). P=8VA (Vac)

2.3 Connecting the analogue inputs

The analogue inputs on the pCO can be configured for the more common sensors on the market: 0 to 1 V, 0 to 10 V, 0 to 20 mA, 4 to 20 mA. The different types of sensors can be selected by setting a parameter on the user terminal.

2.3.1 Connecting the universal NTC temperature sensors

The analogue inputs are compatible with 2-wire NTC sensors. The inputs must be pre-configured for NTC signals by the application program resident in the flash memory. The connection diagram is shown below:

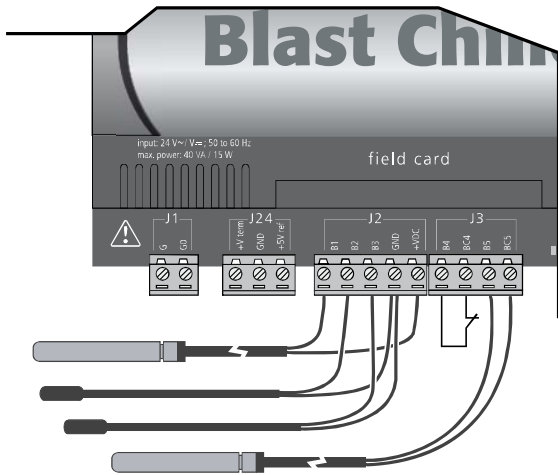

Controller	pCO terminals	NTC sensor cable
pCO ³	GND, BC4, BC5, BC9, BC10	1
	B1, B2, B3, B4, B5, B6, B7, B8, B9, B10	2
pCO ⁵	GND	1
	B1, B2, B3, B4,	2

Important: the two wires of the NTC sensors are equivalent, as they have no polarity, therefore it is not necessary to follow any specific order when connecting to the terminal block.

2.3.2 Connecting the PT1000 temperature sensors

The pCO (pCO³ version only) can be connected to 2-wire PT1000 sensors for all high temperature applications; the range of working is: -100 to 200 °C. The inputs must be pre-configured for PT1000 signals by the application program resident in the flash memory. The connection diagram is shown below:

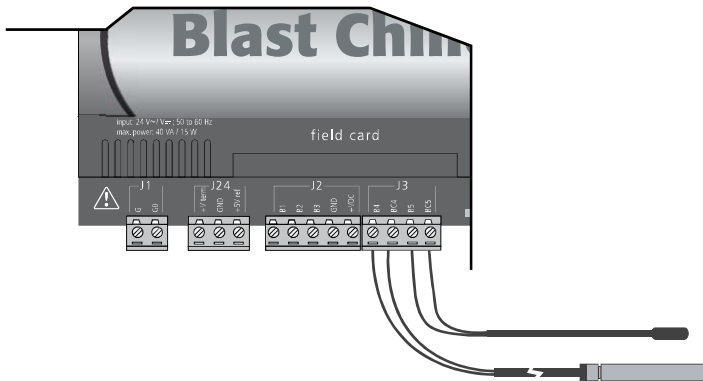

Controller	PT1000 sensor cable			
	sensor 1	sensor 2	sensor 3	probe 4
pCO ³	BC4	BC5	BC9	BC10
	B4	B5	B9	B10
pCO ⁵	not available			

Important:

- for correct measurements using the PT1000 sensor, each sensor wire must be connected to an individual terminal, as shown in Figure 4.c;
- the two wires of the PT1000 sensors are equivalent, as they have no polarity, therefore it is not necessary to follow any specific order when connecting to the terminal block.

2.3.3 Connecting product probes with heaters

The probes with heater (codes NTCINF0340 and PT1INF0340) require the four wires to be connected to the Blast Chiller pCO board; the wires, with different colours, are indicated in the following figure by the numbers described in the table:

	wire colour
1 & 2	Red
3 & 4	White

This represents just one of the possible configurations for the connections. The inputs and outputs effectively used depend on the configuration of the software. On the Blast Chiller pCO³ Small model, the white wire indicated as number 3 can be connected to the GND terminal (as in the figure) or BC4 or BC5; white wire number 4, on the other hand, can be connected to B1, B2 or B3 or B4 or B5.

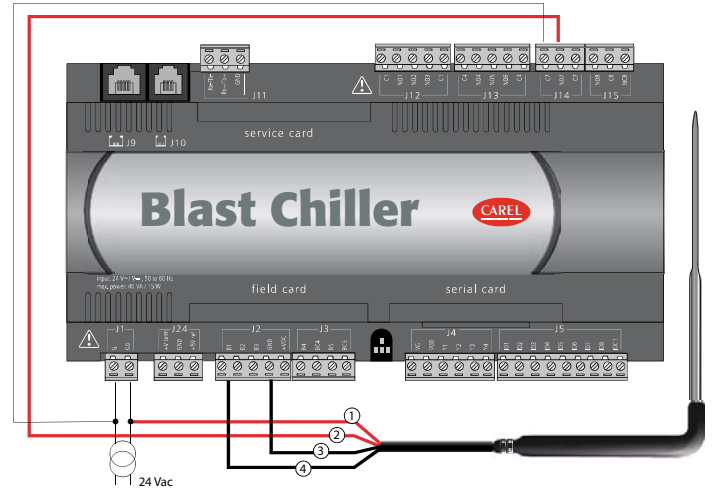

On the Blast Chiller pCO⁵ model, the white wire represented in the following figure as number 4, can be connected, in addition to B1, also to B2 or B3 or B4.

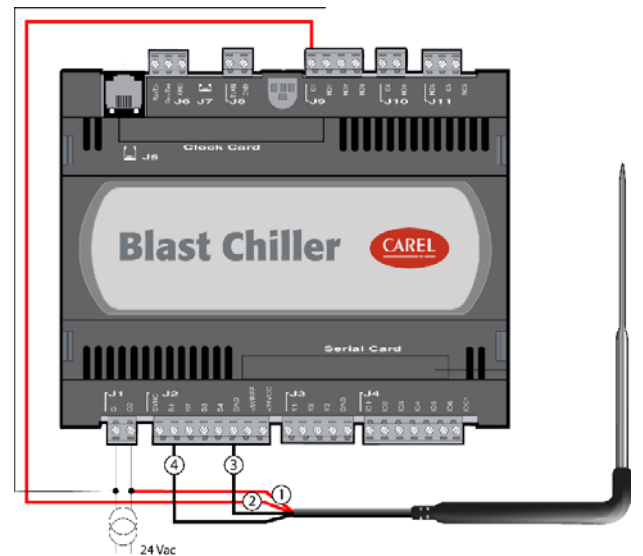

Note: if using NTC or PT1000 probes without heater, the wires indicated by numbers 1 and 2 will not be present.

2.3.4 Connecting the analogue inputs selected as ON/OFF

The pCO allows some analogue inputs to be configured as voltage-free digital inputs. The inputs must be pre-configured as voltage-free digital inputs by the application program resident in the flash memory.

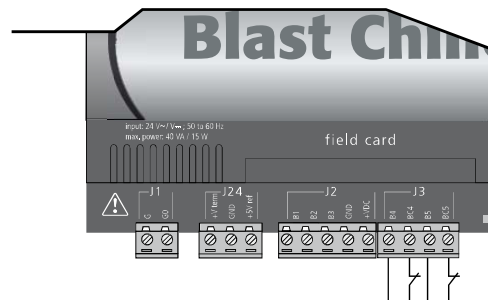

Controller	Digital input cable			
	digit 1	digit 2	digit 3	digit 4
pCO ³	BC4	BC5	BC9	BC10
	B4	B5	B9	B10

pCO^{XS} | Not available

Warning: the maximum current available at the digital input is 5 mA (thus the rating of the external contact must be at least 5 mA). These inputs are not optically isolated.

2.3.5 Remote connection of the analogue inputs

The sizes of the cables for the remote connection of the analogue inputs are shown in the following table:

type of input	size (mm ²) for length up to 50 m	size (mm ²) for length up to 100 m
NTC	0.5	1.0
PT1000	0.75	1.5
I (current)	0.25	0.5
V (voltage)	0.25	0.5

If the product is installed in industrial environments (application of the EN 61000-6-2 standard) the length of the connections must be less than 30 m. This length shouldn't be exceeded in any case, to avoid measurement errors.

2.4 Connecting the digital inputs

The pCO features digital inputs for connecting safety devices, alarms, device status, remote switches. These inputs are all optically isolated from the other terminals. They can work at 24 Vac, 24 Vdc and some at 230 Vac.

Note: separate the sensor signal and digital input cables as much as possible from the inductive load and power cables, to avoid possible electromagnetic disturbance.

Important: if the control voltage is drawn in parallel with a coil, fit a dedicated RC filter in parallel with the coil (the typical ratings are 100 Ω, 0.5 μF, 630 V). If connecting the digital inputs to safety systems (alarms), **remember that:** the presence of voltage across the contact must be the normal operating condition, while no voltage must represent an alarm situation. This will ensure that any interruption (or disconnection) of the input will also be signalled. Do not connect the neutral in place of an open digital input. Always interrupt the phase. The 24 Vac/Vdc digital inputs have resistance of around 5 kΩ.

2.4.1 Digital input connections for the pCO³

The following figure represents one of the most common diagrams for connecting the 24 Vac and 24 Vdc digital inputs on a pCO³.

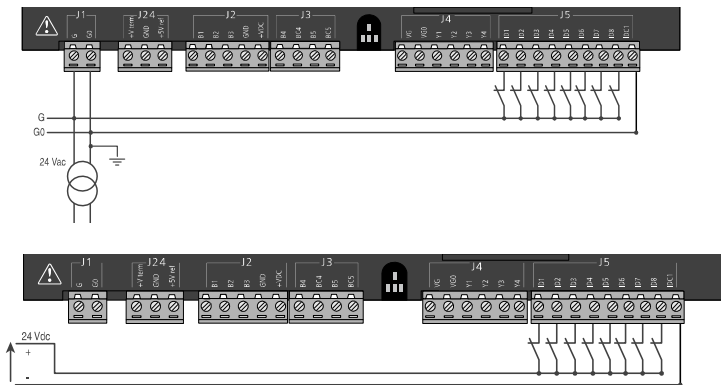

To maintain the optical isolation of the digital inputs, a separate power supply must be used just for the digital inputs. The connection diagrams shown in these figures, which while being the more common and the more convenient, do not exclude the possibility of powering the digital inputs independently from the power supply to the pCO. In any case, the inputs only have functional insulation from the rest of the controller.

2.4.2 Connecting the digital inputs for the pCO^{XS}

The following figure shows the diagram for connecting the digital inputs.

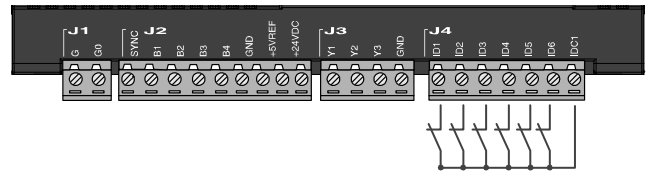

2.4.3 Remote connection of the digital inputs

Important note: do not connect other devices to the IDn inputs. The sizes of the cables for the remote connection of the digital inputs are shown in the following table:

size (mm ²) for length up to 50 m	size (mm ²) for length until 100 m
0.25	0.5

If the product is installed in industrial environments (application of the EN 61000-6-2 standard) the length of the connections must be less than 30 m. This length shouldn't be exceeded in any case, to avoid measurement errors.

2.5 Connecting the analogue outputs

2.5.1 Connecting the 0 to 10V analogue outputs

The pCO provides 0 to 10 V optically-isolated analogue outputs, powered externally at 24Vac/Vdc. Fig. 4.n shows the electrical connection diagram; the 0V (zero) of the power supply is also the reference for the output voltage. The table below shown summarises the distribution of the analogue outputs according to the version available.

	no. of analogue outputs	reference
pCO ³ terminals	Y1, Y2, Y3, Y4	VG0
pCO ^{XS} terminals	Y1, Y2	G0

Important: on the pCO^{XS} the outputs are not optically isolated. Remember, on the other hand, that the pCO^{XS} power supply is insulated.

2.5.2 Connecting the PWM analogue outputs

The pCO^{XS} provides a PWM analogue output for phase cutting speed controllers. The following figure shows the wiring diagram and the two most common connection examples.

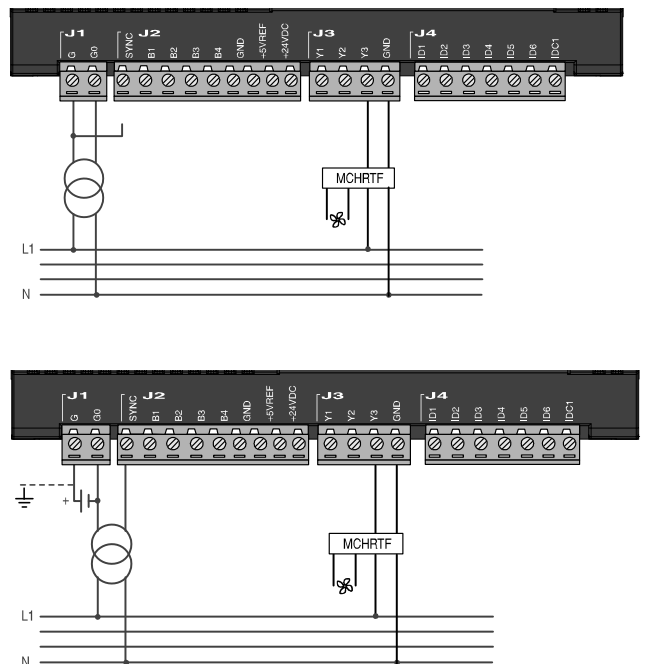

	no. of analogue outputs	reference
pCO ³ terminals	not available	
pCO ^{XS} terminals	Y3	G0

Note: the terminal on the Blast Chiller pCO^{SS} board relating to the PWM analogue outputs can only be used for the evaporator or the condenser fans, and not connected to the steriliser lamp.

Note: the power supply to the circuit measuring the zero crossing is at terminal SYNC on the pCO^{SS} and must be 24 Vac, in phase with the power supply to the actuator: for three-phase power supply, use the same phase to power the pCO^{SS} and the actuator.

2.5.3 Optional modules

The module is used to convert a PWM output (5 V pulses) to a linear 0 to 10 V and 4 to 20 mA analogue output (code CONV0/10A0).

The control signal (at the input terminals optically-isolated from the rest of the module) must have a maximum amplitude of 5V and a period between 8 ms and 200 ms. The 0 to 10 V output voltage can be connected to a maximum load of 2 kΩ, with a maximum ripple of 100 mV.

The 4 to 20 mA output current can be connected to a maximum load of 280 Ω, with maximum overshoot of 0.3 mA.

The mechanical dimensions of the module are 87x36x60 mm (2 DIN modules) with IP20 index of protection.

Module for converting a 0 to 10 V analogue output to an SPDT digital output (code CONVONOFF0)

The module is used to convert a 0 to 10 V analogue output (Yn) to an ON/OFF relay output. The control signal Yn (at the input terminals optically-isolated from the rest of the module), to ensure the switching of the relay from OFF to ON, must have a maximum amplitude of 3.3V. The relay is SPDT, with max current of 10 A and max inductive load of 1/3 HP. The mechanical dimensions of the module are 87x36x60 mm (2 DIN modules) with IP20 index of protection.

2.6 Connecting the digital outputs

The pCO features digital outputs with electromechanical relays. For ease of installation, the common terminals of some of the relays have been grouped together. If the following diagram is used, the current at the common terminals must not exceed the rating (nominal current) of a single terminal (8 A).

2.6.1 Electromechanical relay digital outputs

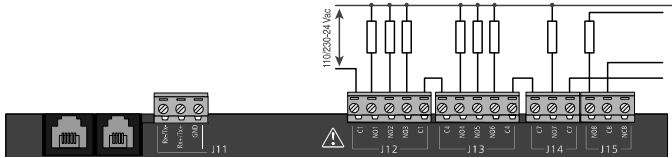

The relays are divided into groups, according to the degree of insulation. Inside each group, the relays have just basic insulation and thus must have the same voltage (generally 24V ac or 110 to 230 Vac). Between the groups there is double insulation and thus the groups can have different voltages. There is also double insulation from the rest of the controller.

2.6.2 Changeover outputs

Some relays feature changeover outputs:

	Changeover relay reference
pCO ³ terminals	8
pCO ^{SS} terminals	5

2.6.3 Solid state relay (SSR) digital outputs

The pCO also features a version with solid state relays (SSR) for controlling devices that require an unlimited number of switching cycles and thus would not be supported by electromechanical relays. They are dedicated to loads powered at 24 Vac/Vdc with a maximum power Pmax = 10 W.

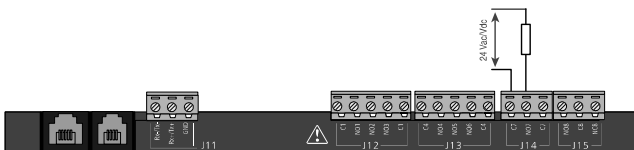

	SSR relay reference
pCO ³ terminals	7
pCO ^{SS} terminals	4, 5

Important: the load of the SSR relay is powered at 24 Vac/Vdc, thus all the other terminals in the group, from 1 to 6, must be powered at 24Vac/Vdc due to the absence of double insulation within the group. Moreover, terminals from 1 to 6 can be powered

at 110-230 Vac using a safety transformer (Class 2) for the power supply to the 24 Vac/Vdc load of the SSR relay.

2.6.4 Summary table of digital outputs according to the versions available

	NO contacts	NC contacts	changeover contacts	total no. outputs	SSR
pCO ³ terminals	7	-	1 (8)	8	1 (7)
pCO ^{SS} terminals	4	-	1 (5)	5	2 (4, 5)

2.6.5 Remote connection of the digital outputs

The sizes of the cables for the remote connection of the digital outputs are shown in the following table:

AWG	Size (mm ²)	Current
20	0.5	2
15	1.5	6
14	2.5	8

If the product is installed in industrial environments (application of the EN 61000-6-2 standard) the length of the connections must be less than 30 m. This length shouldn't be exceeded in any case, to avoid measurement errors.

3 USER INTERFACE

3.1 Graphic terminals

Blast Chiller features of two types of graphic terminal, one version for flush-mounted or panel installation with plastic faceplate, and another version, with membrane keypad, for assembly behind the panel:

terminal with plastic faceplate – dimensions:

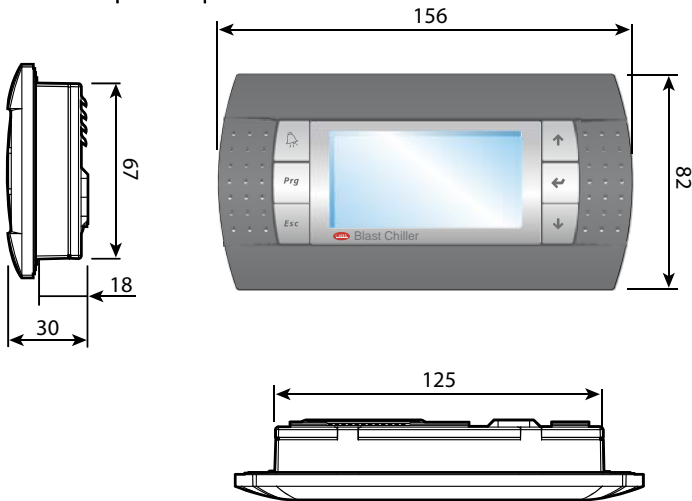

Display	
Type	FSTN graphic
Backlighting	white LEDs (controlled by "application software")
Graphic resolution	132x64 pixels
Text modes	8 rows x 22 columns (5x7 and 11x15 pixel fonts) 4 rows x 11 columns (11x15 pixel fonts) or mixed modes
Character height	3.5 mm (5x7 pixel fonts) 7.5 mm (11x15 pixel fonts)
Size of the active area	66x32 mm
Size of the display area	72x36 mm

Keypad LEDs

2 programmed by "application software", red (Alarm) and green (ON/OFF and repeat cycle buttons);
4 green (other buttons), used to control the backlighting of the LCD.

Power supply

Voltage: power supply from pCO via telephone connector or from 18/30 Vdc external source protected by external 250 mA fuse.
Maximum power input: 1.2 W

terminal with membrane front panel – dimensions:

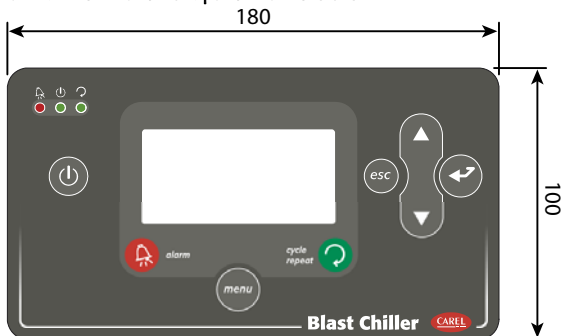

Display	
Type	FSTN graphic
Backlighting	white LEDs (controlled by "application software")
Graphic resolution	132x64 pixels
Text modes	8 rows x 22 columns (5x7 and 11x15 pixel fonts) 4 rows x 11 columns (11x15 pixel fonts) or mixed modes
Character height	3.5 mm (5x7 pixel fonts) 7.5 mm (11x15 pixel fonts)
Size of the active area	66x32 mm
Size of the display area	72x36 mm

Keypad LEDs

3 programmed by "application software", red (Alarm) and green (ON/OFF and repeat cycle buttons);

Power supply

Voltage: power supply from pCO via telephone connector or from 18/30 Vdc external source protected by external 250 mA fuse.
Maximum power input: 1.2 W

3.1.1 Connecting the user terminal to the pCO board

The typical connection between the pGD terminal and the pCO is made using a 6-wire telephone cable supplied by CAREL (code S90CONN00*, see the table). To make the connection, simply plug the cable into the 6-pin connector on the pCO board (J10 for the pCO^{CS} and J5 for the pCO^S), until it clicks into place. To remove the connector, lightly press the plastic catch and remove the cable. The telephone connector provides both the data link and the power supply to the terminal.

User terminal/interface connection cables		
length (m)	type	code
0.8	telephone connectors	S90CONN002
1.5	telephone connectors	S90CONN002
3	telephone connectors	S90CONN001
6	telephone connectors	S90CONN003

Important: The membrane terminal is on the other hand already connected, via the ribbon cable, to the display interface.

3.1.2 Installing the terminal

To make the connection simply plug the telephone cable into the RJ12 telephone connector on the rear of the terminal, and into connector:

- J5 on the pCO^{CS};
- J10 on the pCO^S.

The address of the terminal can be set in the range between 0 and 32; addresses between 1 and 32 are used by the pLAN protocol, while address 0 identifies the **Local terminal protocol**, used for point-point connections without graphics and to configure the pCO. The default address is 32. The address of the terminal can only be set after having connected to power supply via the RJ12 connector. To enter configuration mode, press **↑**, **↓** and **←** together for at least 5 seconds; the terminal will display a screen similar to the following, with the cursor flashing in the top left corner:

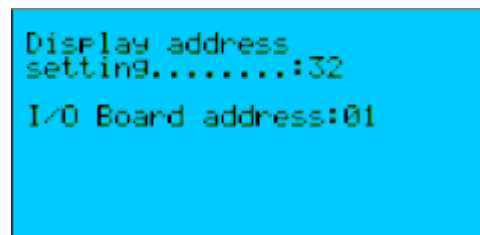

To change the address of the terminal ("Display address setting") proceed as follows, in sequence.

1. Press **←** once: the cursor will move to the "Display address setting" field.
2. Select the desired value using **↑** and **↓**, and confirm by pressing **←** again.
3. If the value selected is different from the one saved previously, the following screen will be displayed and the new value will be saved to permanent memory.

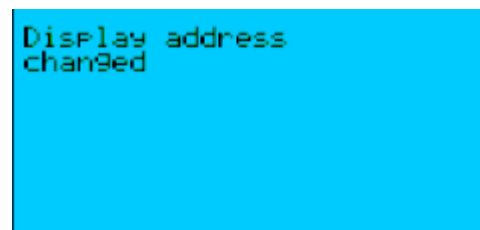

If the address field is set to 0, the terminal communicates with the pCO board using the Local terminal protocol, and the "I/O Board address" field is no longer shown, having no meaning.

To change the list of terminals (private and shared) associated with a pCO board, proceed as follows, in sequence:

4. enter configuration mode (see above), pressing , and at the same time for at least 5 seconds.
5. press twice: the cursor will move to the "I/O Board address" field.
6. select the address of the pCO board being configured and confirm by pressing .

The pCO will then start the configuration procedure, sending a screen similar to the following.

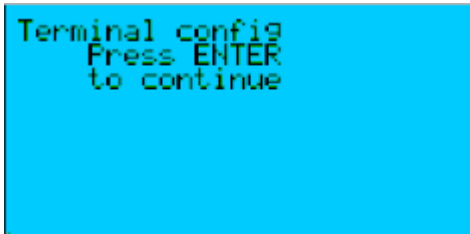

7. Press again: the configuration screen will be shown, similar to the following.

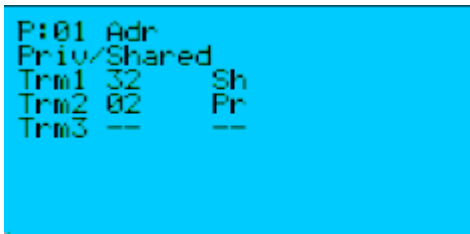

8. Change the terminal configuration as required. The button is used to move the cursor from one field to another, while and change the value of the current field. The P:xx field displays the address of the pCO board selected (in the example shown in the figure, this is board 1).
9. To exit the configuration procedure and save the data, select the "Ok?" field, set "Yes" and confirm by pressing .

During the configuration procedure, if the terminal remains inactive (no button pressed) for more than 30 seconds, the pCO board automatically interrupts the procedure without saving any changes.

Important: if during the operation the terminal detects the inactivity of the pCO board being displayed, the display is cancelled completely and a message similar to the following is shown.

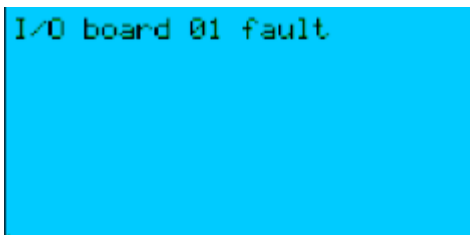

If the terminal detects the inactivity of the entire pLAN network, that is, no message is received from the network for 10 consecutive seconds, the display is cancelled completely and the following message is shown:



To complete the Blast Chiller installation procedure, set the pLAN address on the pCO; the pCO^S and pCO³ controllers do not have dipswitches for setting the pLAN network address: the pLAN address can be set from any pGD1 terminal on the models where fitted.

1. Set address 0 on the terminal (see the previous sections for details on how to select the address).
2. Power down the pCO.
3. Connect the terminal to the pCO.
4. Power up the pCO, pressing the UP and ALARM buttons together on the terminal. After a few seconds, the pCO runs the start-up sequence and the display shows a screen similar to the following:



5. From the moment when the screen is displayed, wait 10 seconds and then release the buttons.
6. The pCO interrupts the start-up sequence and shows a configuration screen similar to the following:

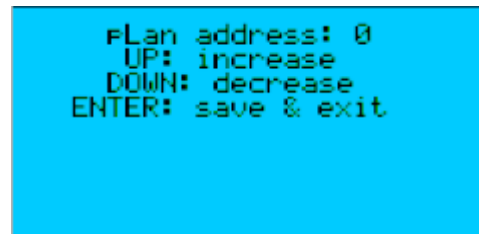

Then change the pLAN address using the and buttons on the terminal.

8. Confirm the address by pressing the button: the pCO completes the start-up sequence and uses the address specified.

Important: for the Blast Chiller the pLAN address of the controller needs to be set to 1 and the terminal to 32; the latter needs to be set as private for board 1. If the settings have not been made correctly, the text and the images on the display will be shown in an incorrect and unordered manner.

Important: When switching the instrument on the first time, wait a few minutes before configuring the terminal and the pLAN address, otherwise the installation of the default values will be interfered with. If the default values are not installed successfully, simply switch the instrument off and on again.

3.2 Navigation buttons

- Alarm	displays the list of alarms.
menu - Menu	used to enter the main menu tree.
Esc - Esc	returns to the previous screen.
- Up	scrolls a list upwards or increases the value shown on the display.
- Down	scrolls a list downwards or decreases the value shown on the display.
- Enter	enters the selected submenu or confirms the value set.
- On/Off**	button to quickly access the On/Off menu.
- Cycle Repeat**	button to quickly access the "Repeat Cycle" menu.

** buttons only available on the membrane interface. The membrane terminal has three additional LEDs, which have the following meaning:

Red	alarm. As the corresponding <i>Alarm</i> button on the membrane does not light up, as is the case on the panel display, this LED is used to visually signal that an alarm has been activated.
Green	chiller On/Off.
Green	cycle running.

4 FUNCTIONS

4.1 Chill and freeze cycles

Blast chill cycles are the main function of the Blast Chiller, and can be divided into two categories: chill cycles and freeze cycles.

A chill cycle significantly reduces the time the food remains in the critical temperature band (from 10°C to 65°C) where there is high probability of bacteria proliferation.

A freeze cycle, on the other hand, tends to reduce the formation of macrocrystals of ice inside the frozen product; such macrocrystals, when forming, affect the organoleptic properties of the food.

The standard values of these cycles are as follows:

	Chill cycle	Freeze cycle
Initial product temperature	90°C	90°C
Final product temperature	3°C	-18°C
Duration	90 min	240 min

The cycles can be defined by time or by temperature. If the cycle has been defined by time, the duration is defined, while if the cycle is defined by temperature, it ends when the product (internally) reaches the set temperature; in both cases, the control probe is the temperature sensor in the blast chiller, used to control the compressor.

A cycle can also be defined as soft or hard; the meaning of soft and hard differs according to whether it refers to a chill cycle or a freeze cycle.

For the chill cycles, if "soft", Blast Chiller works for the entire duration of the cycle considering the final temperature of the blast chiller as the set point (usually around 0°C); on the other hand, if the cycle is "hard", Blast Chiller works with two different temperature set points for the blast chiller, one lower (around -20°C), used until the

internal product temperature reaches the set value or the pre-set time expires, and a second set point, higher (around 0°C), used until the end of the cycle. For the freeze cycles, if "soft", Blast Chiller works with two different set points, the first (higher, around 0°C) used until the product (internally) reaches the set temperature or until the end of a predefined time, the second set point (lower) is then used until the end of the cycle; if, on the other hand, the cycle is "hard", Blast Chiller always works only considering the final set point of the blast freezer (usually around -35°C).

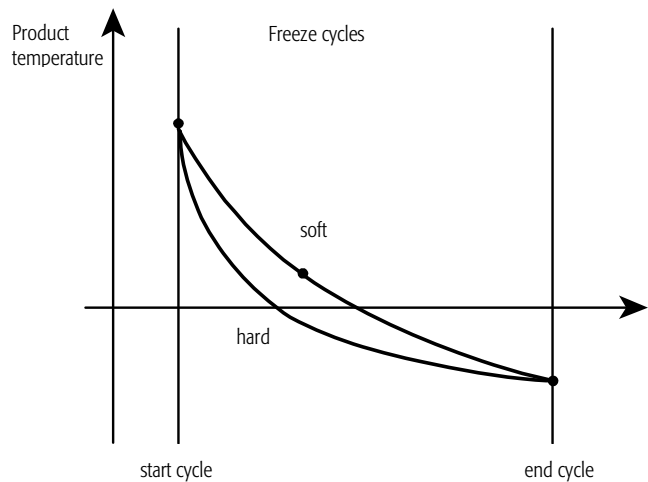
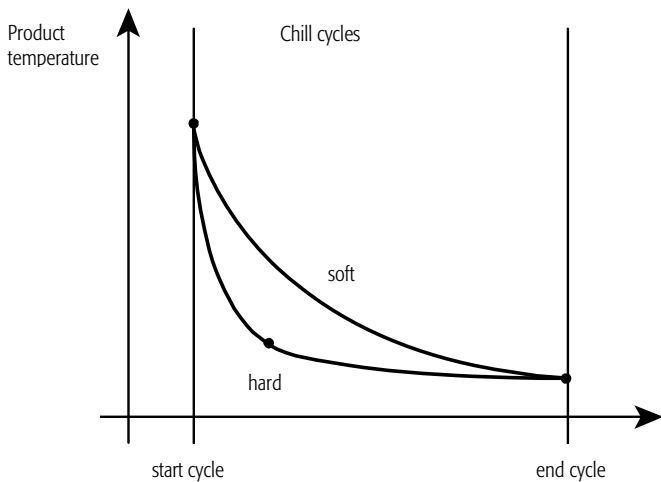
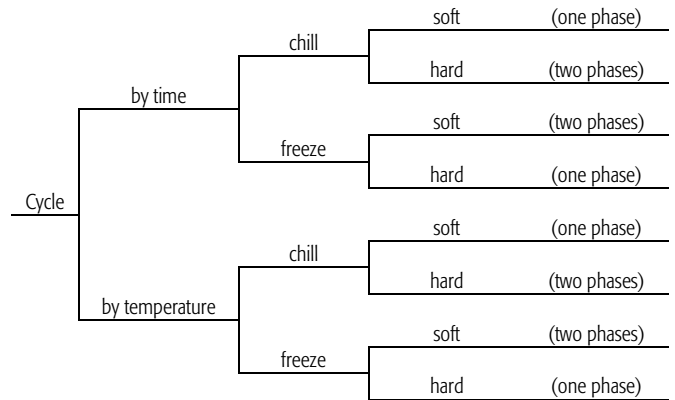

Fig. 4.1 Chill cycles (hard and soft) and freeze cycles (hard and soft).

Blast Chiller features the following preset standard cycles:

- Standard +3°C by temperature, soft
- Standard +3°C by temperature, hard
- Standard +3°C by time, soft
- Standard +3°C by time, hard
- Standard -18°C by temperature, soft
- Standard -18°C by temperature, hard
- Standard -18°C by time, soft
- Standard -18°C by time, hard

These cycles are set according to the following set points and durations:

Cycle		phase 1			phase 2			Conservation blast chiller
		blast chiller	product	time	blast chiller	product	time	
Chill cycles	Standard +3°C by temperature soft	0 °C	3 °C	90 min	---	---	---	2 °C
	Standard +3°C by temperature hard	-20 °C	10 °C	60 min	0 °C	3 °C	30 min	2 °C
	Standard +3°C by time soft	0 °C	---	90 min	---	---	---	2 °C
	Standard +3°C by time hard	-20 °C	---	60 min	0 °C	---	30 min	2 °C
Freeze cycles	Standard -18°C by temperature soft	0 °C	3 °C	120 min	-35 °C	-18 °C	120 min	-20 °C
	Standard -18°C by temperature hard	-35 °C	-18 °C	240 min	---	---	---	-20 °C
	Standard -18°C by time soft	0 °C	---	120 min	-35 °C	---	120 min	-20 °C
	Standard -18°C by time hard	-35 °C	---	240 min	---	---	---	-20 °C

Blast Chiller also allows the user to define up to ten custom cycles, changing the values of the parameters according to needs.

The custom cycles can be set starting from one of the standard cycles (made up of two phases) or alternatively using the "complete" option, made up of three phases, all configured by the user:

1. quick chill
2. controlled chill
3. quick freeze

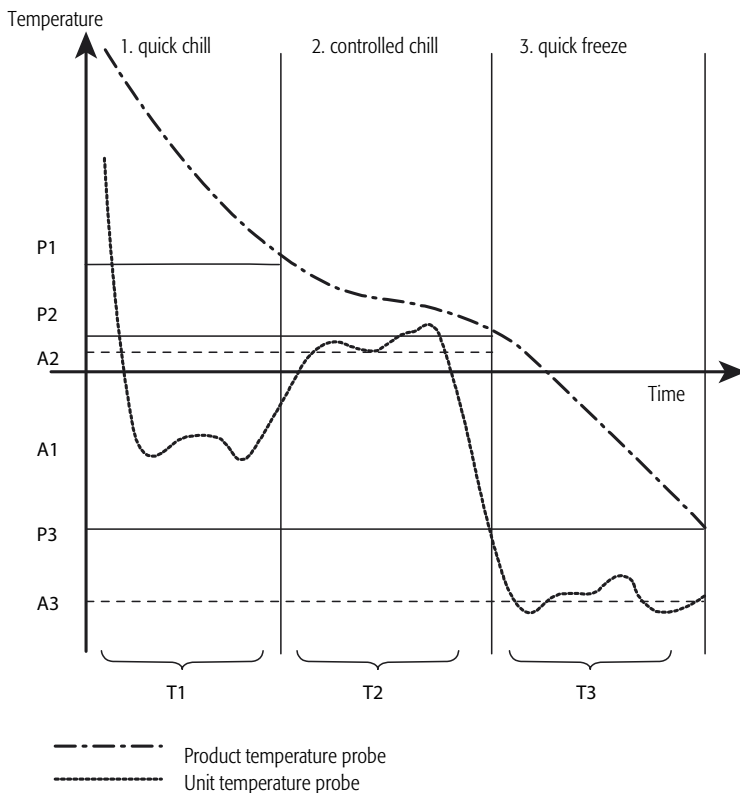

Fig. 4.2 Complete cycle.

Phase 1 is used to quickly chill food that has just been cooked, phase 2 to avoid the formation of ice on the surface of the products, and phase 3 to freeze quickly.

Each phase has the following parameters:

- blast chiller temperature set point A1, A2, A3 in Fig. 4.2
- duration (cycle by time) or maximum duration (cycle by temperature) T1, T2, T3 in Fig. 4.1
- product temperature set point for the final phase (cycle by temperature) P1, P2, P3 in Fig. 4.2.

If one of the time parameters T1, T2, T3 is set to zero, the corresponding phase is skipped.

If a cycle is being managed "by time", the product set points (P1, P2 and P3) are not evaluated; if, on the other hand, a cycle is managed "by temperature", the time parameters (T1, T2 and T3) are used as maximum duration of the three phases; if the set point P3 is not reached throughout the cycle (T1+T2+T3), this does not end, but rather continues until the set point is reached, with an alarm signalling the event.

If at the end of the cycle a conservation phase is set, Blast Chiller brings and maintains the blast chiller/freezer at the set conservation temperature.

The end of a cycle is signalled by an audible buzzer.

Note: if when running a cycle there is a power failure or the door of the blast chiller/freezer is opened, the cycle starts again from the point it was interrupted, if the duration is less than the set point, if, on the other hand, the duration is greater than set point, the cycle is terminated and an alarm signals the event.

Note: when running a cycle, custom cycles cannot be created or saved.

How to use one of the standard cycles:

1. from the main menu → Cycle → Standard cycle;
2. scroll the list of the standard cycles (using ↑ and ↓);
3. choose (from the 8 available) one of the standard cycles, pressing ← for 3 seconds.

Note: the cycle ends when the end conditions are satisfied, or can be stopped by the user (Stop)

How to create and use a custom cycle (3 phases –most complete example):

1. from the main menu → Settings;
2. enter the password (any, from PW1, PW2 and PW3) → Custom cycle;
3. scroll the list of the standard cycles (using ↑ and ↓) that can be used as the base for setting a custom cycle (one, two or three phases);
4. select Complete (cycle with three phases) → now choose whether to set the cycle "by time" or "by temperature";
5. Blast Chiller now requires the settings for phase 1, the set point of the blast chiller/freezer, the product set point and the duration of the phase (↑ and ↓ modify the value and ← confirms and moves to the next step);
6. perform the same operations described in point 5 for phase 2 and phase 3;
7. choose Yes or No to set a conservation phase at the end of the cycle and set the corresponding set point;
8. in addition, a defrost phase can be set before the cycle and/or before any conservation phase.
9. then a final screen is displayed for saving the custom cycle with a name (up to 15 alphanumeric characters and the symbols +, -, ° and space) plus a cycle identifier number (from 1 to 10);
10. pressing ← for 3 seconds saves the cycle;
11. return to the main menu → Cycle → Custom cycle;
12. this submenu includes the list of all the custom cycles created; a cycle can be selected from the list and run using the same procedure as for any standard cycle.

Note: up to 10 custom cycles can be saved; after the tenth, Blast Chiller overwrites one of the other custom cycles already configured with the new cycle created.

4.1.1 Probe errors and overstock

Input: blast chiller/freezer temperature probes and product temperature probes.

Parameters: probe differential not entered correctly, probe delay out-of-range, overload check period, blast chiller/freezer set point and product set point, maximum duration of the cycle.

Description of the function:

there are three items relating to the value measured by the probes:

- product temperature out-of-range
- product temperature probe not inserted correctly
- product overstock

Product temperature out-of-range

If an NTC sensor is selected, with a range from -50°C to 90°C, at the start of the cycle the product temperature may be greater than 90°C; in this case, the probe alarm and the value displayed are disabled.

A flashing message (">90°C") is displayed, and stops when the temperature measured returns within the specified range, that is, less than 90°C.

If, however, after a certain delay (settable by parameter), the value measured and displayed continues to remain outside of the range, it means that the probe is faulty and an alarm is signalled.

Probe not inserted

If a cycle is selected by temperature and the product temperature probe is not working or has not been inserted correctly, an alarm signals the event and the cycle ends by time.

Overload

When the cycle starts or the door is closed, a check is performed to evaluate the risk of overstock. If the outcome is negative, the check is repeated after a set check period and if still negative, an overstock alarm is signalled.

The check is performed both on the blast chiller/freezer temperature and the product temperature.

4.1.2 Enable negative temperature cycles

Parameters: Enable negative temperature cycles, minimum product set point temperature, minimum set point cold room temperature.

Description of the function:

The selection and execution of negative temperature cycles can be enabled/disabled using the enable negative temperature cycles parameter. If the negative temperature cycles are disabled by the manufacturer, the set of cycles that can be selected by the user is limited to the following:

- Standard + 3 °C by temperature, soft
- Standard + 3 °C by temperature, hard
- Standard + 3 °C by time, soft
- Standard + 3 °C by time, hard

In addition, when saving a custom cycle, a custom cycle can only be created starting from positive temperature cycles, with one or two phases.

Note: to prevent the user from setting a negative temperature set point, the values of the minimum product temperature set point and minimum cold room temperature set point parameters must be set suitably.

4.2 Temperature control

Input: blast chiller/freezer temperature probes, day/night switch.

Parameters: blast chiller/freezer temperature set point, control differential, type of blast chiller/freezer temperature value calculation, set point deviation with day/night switch, differential deviation with day/night switch, parallel operating mode of the compressors.

Description of the function:

temperature control is performed by evaluating the temperature of the blast chiller/freezer and generating the temperature control request, as shown in the following figure.

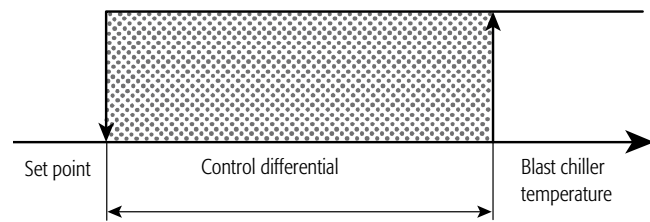

Fig. 4.3 Temperature control.

If a compressor has been configured for the second phase, there are two possible situations:

- if parallel operating mode is selected, temperature control follows the diagram in Fig. 4.3; the differential and the set point for each phase are the same and the second phase is activated after having waited the delay time between the start of different compressors;
- if on the other hand parallel operating mode has not been selected, then temperature control follows the diagram in Fig. 4.4; the differential for each phase is half of the control differential, while the set point for the second phase is equal to the control set point plus half of the control differential.

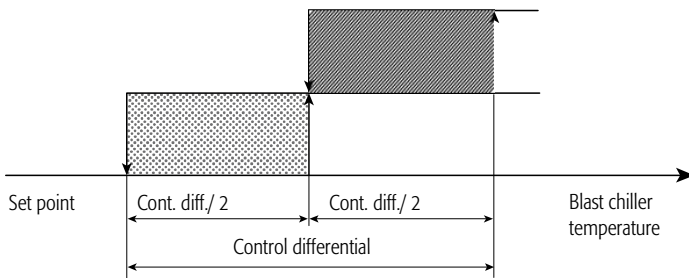

Fig. 4.4 Temperature control with second phase.

If there is more than one blast chiller/freezer probe, the value is calculated considering the values read by the various probes and the settings defined for the type of calculation, which may be:

- Highest: the temperature of the blast chiller is the highest of the values read;
- Average: the temperature of the blast chiller is the average of the values read.

Note: the set point and the differential can be adjusted by a set point deviation with day/night switch and a differential deviation with day/night switch when the digital input is active: the set point used then is the set plus the set point deviation, and the differential is the differential plus the differential deviation.

4.3 Compressor management

Parameters: number of compressors, parallel operating mode of the compressors, delay when starting the compressors, minimum time between starts of the same compressor, minimum on time, minimum off time, second phase delay, enable rotation, compressor stop when opening the door, door open delay, parallel operating mode.

Output: compressor, second-phase compressor.

Description of the function:

the compressor and second-phase compressor parameters can control two different compressors that operate together (this means that all the functions that require the activation of the compressor act on both outputs). If the number of compressors parameter is equal to 1 or the second-phase compressor is not configured, then Blast Chiller manages just one compressor.

If there are two compressors and rotation has been enabled, these will be managed based on FIFO logic (first-in-first-out): the first compressor to start is the first to stop. The activation of the compressors must also observe the settings relating to the time delays:

- delay when starting the compressor: this time must elapse before starting it to prevent the compressor from continuously restarting in the event of frequent blackouts.
- Minimum time between different starts of the same compressor: this time must elapse before the compressor starts again, even if the compressor has been called to start. This parameter is used to limit the number of restarts per hour for each compressor.
- Minimum time between starts of different compressors: time that must elapse before starting the second-phase compressor, even if the compressor has been called to start. This parameter is used to avoid the simultaneous starting of both compressors.
- Minimum on time: once on, the compressor cannot be stopped until this time has elapsed. In the event of overload, this time is ignored.
- Minimum off time: once off, the compressor cannot be started again until this time has elapsed.
- The parameters described here are valid for both compressors (compressor and second-phase compressor).

If the door is opened, the compressors either remain in their current status or are switched off, depending on the settings made in the section corresponding to shutdown with the door open. If the door is opened longer than the door open delay, the compressor is reset and starts operating normally.

If the second-phase compressor has been set, operation is the same as described in the previous paragraph.

4.3.1 Duty setting

Input: blast chiller/freezer temperature probes

Parameters: duty setting on time, duty setting off time.

Output: compressor, second-phase compressor.

Description of the function:

in the event of control probe errors, the compressor can be kept on until the problem is resolved. The compressor remains on for a duty setting on time and off for a duty setting off time.

If the duty setting on time is set to 0, the function is ignored and the compressor remains off in the event of probe errors. If, on the other hand, the duty setting off time is set to 0, the compressor operates continuously in the event of probe errors.

If the probe error occurs while the compressor is off, this remains off for the duty setting off time, and then is started and remains on for the duty setting on time, then stopped and started again, as illustrated in Fig. 4.5.

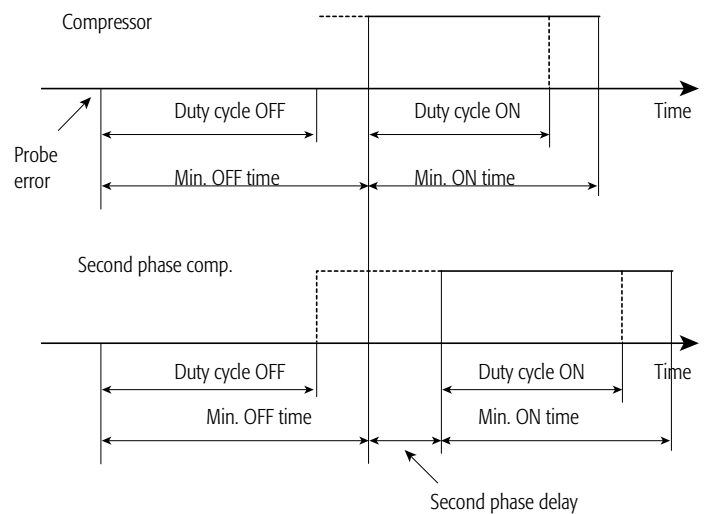

Fig. 4.5 Duty setting (a).

If, on the other hand, the probe error occurs while the compressor is operating, it remains on for the duty setting on time and is then stopped and remains off the duty setting off time, then starting again, as described in Fig. 4.6.

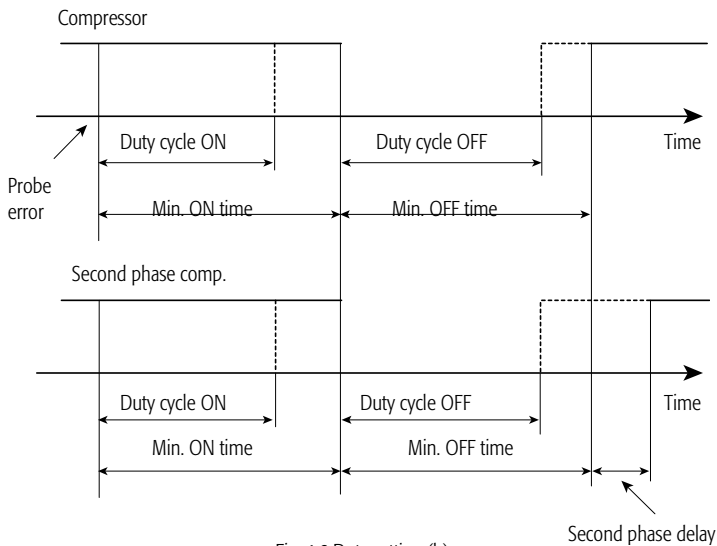

Fig. 4.6 Duty setting (b).

As soon as the probe errors are resolved, normal control resumes.

Note: if the second-phase compressor has also been configured, the two duty setting parameters act on both phases. Rotation continues to be applied, as does the minimum time between the starts of different compressors.

4.3.2 Continuous operating mode

Parameters: continuous operating mode duration, low temperature alarm delay after continuous operating mode.

Output: compressor, second-phase compressor

Description of the function:

during continuous operating mode, the compressor continues operating normally, ignoring temperature control, for the entire duration of the operating mode. The temperature of the blast chiller/freezer may fall below the set point, however cannot fall below the low temperature alarm threshold. Consequently, continuous operating mode can end for two reasons:

- the set duration elapses;
- the low temperature alarm threshold has been reached.

The mode can be activated if:

- the duration has been set to 0;
- the temperature is below the low temperature alarm threshold.

Finally, continuous operation remains pending when:

- the compressors timers are in progress;
- a compressor alarm is active;
- the defrost, dripping and post-dripping functions are in progress;
- the door is open.

If one of the digital inputs has been configured as the door switch, when the door is opened, continuous operating mode is stopped; once the door is closed again, the mode resumes from the point (time) where it was stopped.

If the second-phase compressor has also been configured, continuous operating mode acts on both phases, and rotation and the compressors timers are observed.

4.3.3 Pump down

Input: low pressure switch.

Parameters: enable pump down, select type of end pump down, maximum pump down time, enable compressor auto-start in pump down, delay time between pump down valve activation and compressor start.

Output: compressor, second-phase compressor, pump down valve.

Description of the function:

the pump down procedure starts when the compressor is stopped, both by the temperature controller and when the Blast Chiller is switched off. If the compressor, or more in general, the Blast Chiller is shutdown due to a serious alarm, the pump down procedure is not run.

When the pump down procedure starts, the corresponding valve is closed and the compressor runs until the end of the procedure, as shown in Fig. 4.7.

When the temperature control process calls the compressor to start, the pump down valve is opened and, after a delay time, the compressor is started.

If the compressor is called to stop while the valve is open, however the compressor is already off, the valve is closed and the pump down procedure starts. If, on the other hand, there is a start call while the valve is closed and the compressor is already on, the valve is immediately opened.

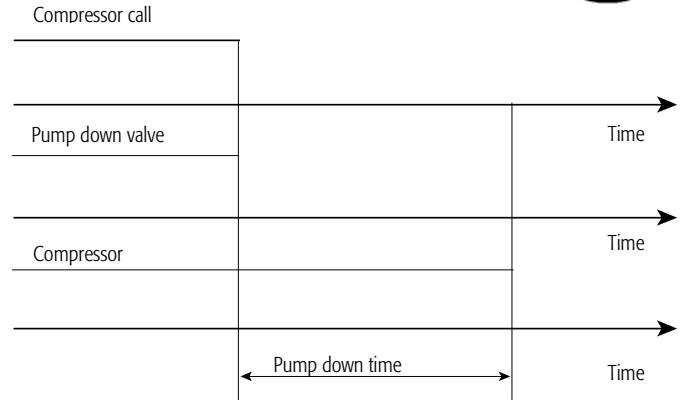

Fig. 4.7 Pump down.

The pump down procedure ends when the low pressure value is reached or the maximum duration has elapsed, depending on the selection made relating to the pump down mode (by pressure or by temperature).

During pump down, once the compressor has been stopped in order to reach the low pressure value, if the pressure still falls (for example, due to leaks from the valve), the compressor is started again until the low pressure is reached. This procedure is called auto-start.

Note: the auto-start procedure observes the minimum compressor off time and minimum time between different starts of the same compressor, but not the minimum on time.

If this procedure has been disabled, pump down is run whenever the temperature control process calls the compressor to stop; if, on the other hand, auto-start is enabled, the pump down procedure is run even when the low pressure switch signals that the pressure has increased and there is no call to start the compressor.

Auto-start is disabled in the following cases:

- Blast Chiller is off;
- before startup;
- if the corresponding parameter is set to 0;
- in the event of pump down alarms;
- if the pump down procedure ends after having exceeded the expected duration.

4.3.4 Stop compressor due to external alarm

Input: External alarm.

Parameters: compressor operating time with external alarm, compressor off time with external alarm.

Output: compressor, second-phase compressor.

Description of the function: if any external alarm has been activated, Blast Chiller works in similarly to duty setting mode. In fact, in the event of external alarms, the compressor can be kept on until the problem has been identified and resolved. The compressor is on for a compressor operating time with external alarm (set by parameter) and off for a compressor off time with external alarm. Setting the corresponding parameters to 0, the functions are ignored (compressor on-off).

Note: if duty setting mode has been activated at the same time, the time values used are those relating to the compressor on and off with external alarm and not the on-off times corresponding to duty setting.

4.4 Fan management

4.4.1 Evaporator fans

Input: blast chiller/freezer temperature probes, evaporator temperature probe.

Parameters: type of fan control, evaporator fan control set point, fans off when compressor off, fan operation during defrost, post-discharge duration, evaporator fan control differential, minimum evaporator fan output, maximum phase shift, minimum phase shift, triac pulse width, mains frequency, fan start delay at power on, fans off when opening the door, door switch delay, fan speed up time.

Output: evaporator fans.

Description of the function:

the evaporator fans can be managed in different ways, depending on the settings made for the type of control and whether the fans are off when the compressor is off.

The following types of fan control are available:

- no control;
- based on the difference between the blast chiller/freezer temperature and the evaporator temperature;
- based on the evaporator temperature only;

in addition, the fans off when compressor off parameter can be used to set the fans as always on or only on when the compressor is running.

Fans off when compressor off	Type of fan control	Fan behaviour
Fans always on	no control	Always on
	based on the difference between blast chiller/freezer temperature and evaporator temperature	Depending on the temperature of the evaporator and the blast chiller
	based on the evaporator temperature only	
Fans on when the compressor is on.	no control	On when the compressor is on.
	based on the difference between blast chiller/freezer temperature and evaporator temperature	On when the compressor is on, depending on the temperature of the evaporator and the blast chiller
	based on the evaporator temperature only	

Note: if two compressors have been configured and the start fans when compressor is started option is set, the fans are on when at least one of the two compressors is on and off only when both compressors are off.

In the event of probe errors, the fans are always on. If the blast chiller door is opened, the fans remain in their current status or are stopped, depending on the configuration of the corresponding parameters. In addition, control can be managed in modulating mode (Fig. 4.9) or in on/off mode (Fig. 4.8).

Control based on the diff. between blast chiller temp. and evaporator temp.

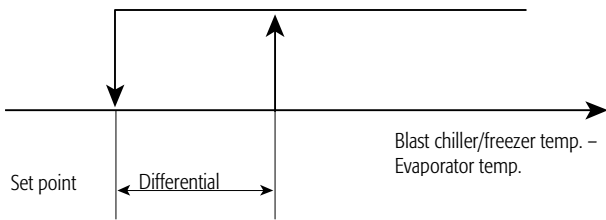

Control based on the evaporator temperature

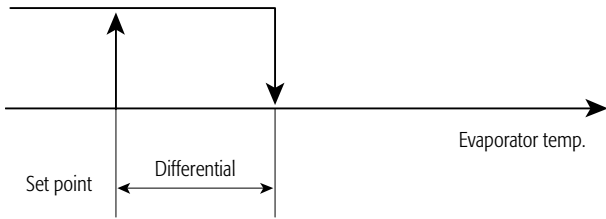
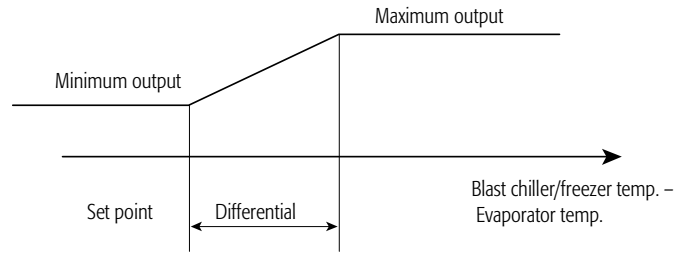

Fig. 4.8 ON/OFF evaporator fan control.

Control based on the diff. between blast chiller temp. and evaporator temp.



Control based on the evaporator temperature

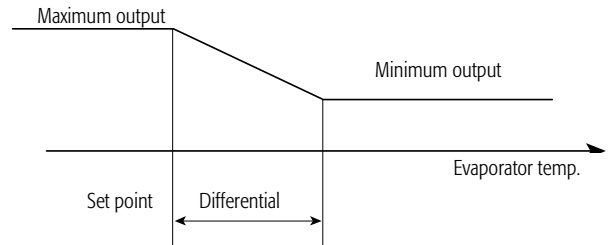

Fig. 4.9 Modulating evaporator fan control.

Note: if the version fitted on the pCO^{SS} board is being used, a PWM analogue output can be managed. If output Y3 is configured for the evaporator fans, these must also be managed by the parameters relating to maximum and minimum phase shift, triac pulse width and mains frequency. In this mode, the following hardware modules can be connected: FCS*, CONVONOFF, CONV0/10A0 or MCHRT* series.

4.4.2 Condenser fans

Input: Condenser temperature.

Parameters: condenser fan off temperature set point, condenser fan off differential, condenser fan start delay at power up.

Output: condenser fans.

Description of the function:

the condenser fans can be managed in modulating mode (described in Fig. 4.11) or on/off mode (Fig. 4.10), if both the condenser fan temperature probe and the output have been configured.

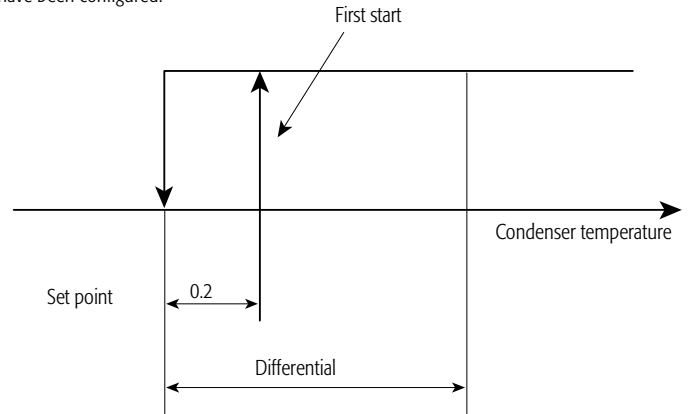

Fig. 4.10 ON/OFF condenser fan control.

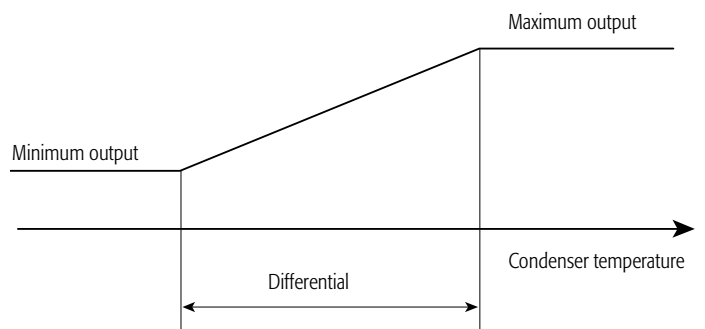

Fig. 4.11 Modulating condenser fan control.

The behaviour is however different when the compressor is first started, as the activation threshold has a fixed differential of 0.2 °C.

In the event of probe errors, the fans are always on.
 If compressor stop due to external alarm has been configured in such a way that the compressor remains on when an alarm occurs, and in addition the condenser fan temperature probe and the output have been configured, the fans will always be on, based on control.
 If the condenser temperature probe has not been configured, yet the output has been configured, the fans are always off.

Note: if the version fitted on the pCO^{3S} board is being used, a PWM analogue output can be managed. If output Y3 is configured for the condenser fans, these must also be managed by the parameters relating to maximum and minimum phase shift, triac pulse width and mains frequency. In this mode, the following hardware modules can be connected: FCS*, CONVONOFF, CONV0/10A0 or MCHRT* series.

4.5 Defrost

Input: enable defrost/activate defrost, evaporator temperature probe.
Parameters: type of defrost, time between defrosts, start defrost temperature threshold, end defrost temperature threshold, maximum defrost duration, defrost activation delay, dripping time, compressor protection in relation to defrost priority, defrost day and time on real time clock, temperature controlled defrost differential.
Output: defrost relay.

Description of the function:

the defrost function can be activated in the cases following:

- before running a cycle (if set);
- before starting the conservation phase (if set);
- in the conservation phase, if the time between defrosts has expired;
- in the conservation phase, if set using the scheduler;
- in the conservation phase, if called by the defrost activation digital input;
- in the conservation phase, if started from the keypad;
- in the conservation phase, if called by the supervisory system;
- Manual.

The defrost can be managed in one of the following modes, depending on the settings of the corresponding parameters:

- by temperature, with electric heater;
- by temperature, with reverse cycle (hot gas);
- by time, using electric heater;
- by time, with reverse cycle (hot gas);
- by time, with electric heater and temperature control.

The defrost by temperature can only be run if the evaporator temperature probe has been configured, otherwise the defrost can only be run in "time" mode.
 Defrosts with temperature control can also only be run if the evaporator temperature probe is installed and is working correctly. In this case, the relay is closed when the temperature reaches the end defrost temperature threshold and is open when the temperature is lower than the end defrost temperature threshold minus the temperature controlled defrost differential. Defrosts with temperature control can only end by time.

The operating principle of the defrost by temperature is shown in Fig. 4.12
 When the defrost is called, the system checks whether the value measured by the temperature probe is lower than the start temperature threshold (point A), if the check is positive, after having waited the defrost activation delay time, the defrost starts (point b).

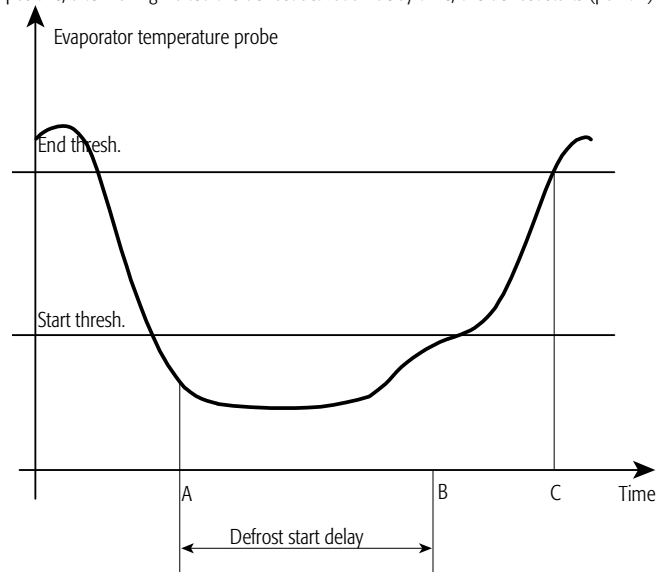

Fig. 4.12 Defrost by temperature.

The defrost cannot start in the following cases, not even if the conditions are right:

- if the defrost digital input has not been enabled;
- if the compressor timer is in progress;
- if the low pressure alarm is active (only for the defrost with reverse cycle);
- if the pump down procedure is active;
- in continuous operating mode;
- if the door of the blast chiller/freezer is opened (only for the defrost with reverse cycle and if the compressor is off);
- if the high condenser temperature alarm is active (only for the defrost with reverse cycle);
- if an external alarm is active.

When the system calls the defrost before starting a cycle and the defrost is pending, the display shows the cycle running screen with the defrost icon flashing, telling the user that the cycle cannot start. If, on the other hand, the defrost is set before the conservation phase, the icon flashes, but the program also starts the conservation phase as the defrost can also be run during this phase.

The defrost by temperature can end if the value read by the probe exceeds the end temperature threshold or because the maximum duration of the defrost has elapsed; in this case, an alarm is generated.

An alarm is also generated if the defrost ends because the temperature probe is broken. During the defrost, the fans may be on or off, in any case at the end of the defrost a dripping phase can be set, depending on the settings of the corresponding parameter (setting the dripping time to 0 skips the operation).

At the end of the defrost phase:

- if the dripping phase has been set, the compressors are stopped using the pump down procedure (if enabled). If, on the other hand, this phase has not been set, the compressors remain in the previous status and normal control resumes;
- if the dripping and the post-dripping phase has been set, the fans are off. If, on the other hand, these phases have not been set, the fans remain in the previous status and normal control resumes;
- the defrost relay is deactivated;
- the post-defrost alarm delay is deactivated;
- if there are defrost calls pending, these are reset.

The defrost procedure can also be completed:

- if the digital input has been disabled;
- Blast Chiller is stopped from the keypad, supervisor or digital input;
- if the phase is terminated from the keypad or controlled by the supervisor.

Note: in these cases, the dripping and post-dripping phases are skipped.

4.5.1 Defrost scheduler

Parameters: type of defrost scheduler, day hours and minutes of the first defrost, ..., day hours and minutes of the eighth defrost.

Description of the function:

the defrost can be programmed in three different ways (shown in Fig. 4.13):

1. first defrost at the start of the conservation phase and the next defrosts planned in the intervals between defrosts;
2. first defrost at a certain time (preset) and the next defrosts planned in the intervals between defrosts;
3. defrosts at set times (up to 8).

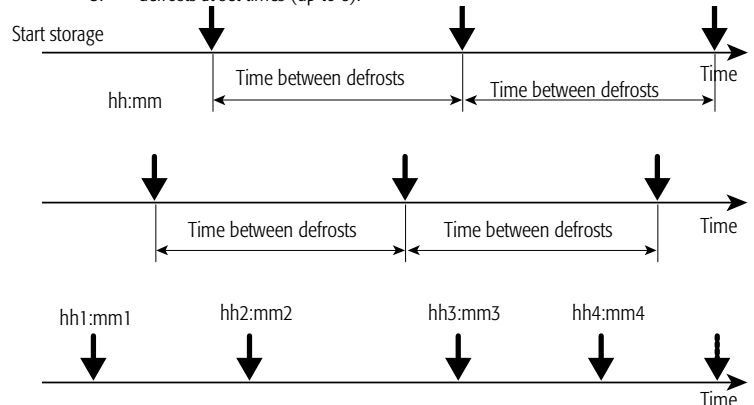

Fig. 4.13 Defrost scheduler.

Note: the interval between defrosts must always be set, as it is used if there are Time problems with the internal clock (Real Time Clock).

4.5.2 Advanced defrosts

Parameters: select type of advanced defrost, nominal defrost duration, proportional factor in the time variation between defrosts.

Description of the function:

there are three types of advanced defrost, which can be set using the corresponding parameters:

1. variable time between defrosts:
with this type of defrost, the time between defrosts is increased or decreased depending on the duration of the previous defrost. The defrost time is calculated as follows:

$$I_{n+1} = I_n + \left[\left(\frac{dn}{100} - \frac{dE_n}{dP} \right) * I_n * \frac{dH}{50} \right]$$

where:

I_n = time between defrosts;

dn = nominal duration of the defrost in "normal" operating conditions, expressed as a percentage of the maximum defrost duration;

dE_n = current duration of the previous defrost;

dP = maximum defrost duration;

dH = proportional factor: used to increase or decrease the influence of the duration of the current defrost. If $dH = 0$ this has no influence.

The time between defrosts is limited between $ln/2$ and $2I_n$.

2. Skip defrost:
the completion of the defrost is based on the previous defrost duration.
If the defrost duration is less than or equal to $\frac{dn}{100} dP$, the next defrost is skipped.
When the defrost is next run, the check is repeated and if the duration is still less than or equal to $\frac{dn}{100} dP$, the next two defrosts will be skipped, and so on until three consecutive defrosts.
If three consecutive defrosts are skipped, the sequence restarts, and the next time the duration calculated is less than or equal to $\frac{dn}{100} dP$, only one defrost will be skipped.
When Blast Chiller is started, seven defrosts are completed before checking the duration.
3. Combination of the previous two modes:
with this type of defrost, the time between defrosts is increased or decreased based on the previous defrost, and the completion of the defrost is also based on the duration of the previous, as described for the previous types and in Fig. 4.14.

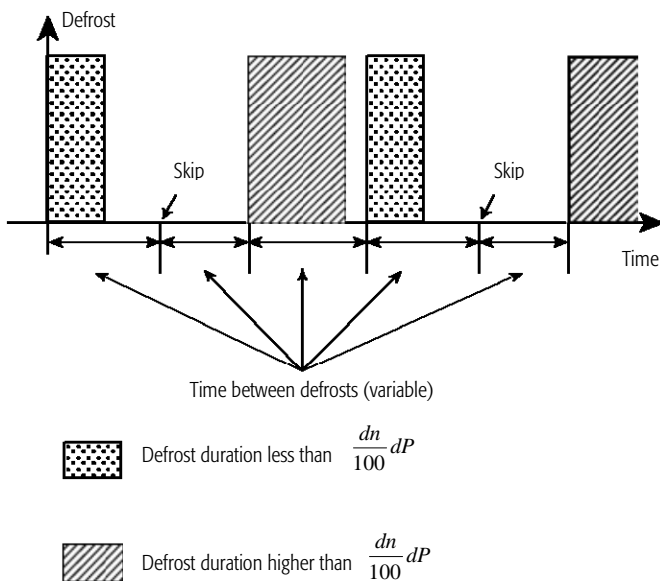

Fig. 4.14 Combination of variable time between defrosts and skip defrost.

4.5.3 Manual defrost

Parameters: type of defrost, maximum defrost duration, fan operation during defrost, dripping duration, post-dripping duration.

Description of the function:

The manual defrost can be activated by the user from the Conservation menu (right side of the bar at the bottom) regardless of whether the conservation phase is in progress.

The manual defrost only involves the activation of the evaporator fans (according to the setting of the fan operation during defrost parameter) for the maximum duration set, or until the user stops it manually.

The dripping and post-dripping phases, if set, are performed.



Note: for this type of defrost, the evaporator probe is not normally envisaged, nonetheless if this is configured, the start and end defrost thresholds can be set.



Note: the manual defrost can

4.6 HACCP (Hazard Analysis and Critical Control Point)

Input: blast chiller/freezer temperature probe.

Parameters: blast chiller/freezer HACCP high temperature alarm threshold, alarm blast chiller/freezer high temperature delay, HACCP alarm delay, maximum blackout duration during a cycle, maximum blackout duration during conservation, type of HACCP threshold.

Description of the function:

this function of the Blast Chiller is used to record possible anomalies when running cycles or during the conservation phase. The following anomalies are recorded:

- cycle ended when exceeding the maximum time due to problems with the probe;
- cycle ended after the maximum time;
- blackout when running the cycle;
- blackout during the conservation phase;
- HACCP high temperature alarm threshold exceeded;

If the "cycle by temperature" mode has been selected and a probe error occurs, the cycle ends when the maximum time set is reached, and the following are saved:

- date and time;
- final product temperature;
- the type of HACCP alarm (that is, in this case, cycle ended by exceeding maximum time).

If, on the other hand, when the "cycle by temperature" is selected the cycle ends when exceeding the maximum time set, the following are saved:

- date and time;
- the extra time required for the product to reach the final temperature;
- the type of HACCP alarm (in this case, "cycle ended by exceeding maximum time").

in the event of blackout when running a cycle, the following data are saved:

- date and time;
- duration of the blackout;
- the type of HACCP alarm (blackout when running a cycle).



Note: if the duration of the blackout is greater than the maximum blackout duration set, the cycle is stopped.

If the blackout occurs during the conservation phase and the duration is greater than the value set for the corresponding parameter, and at the end of the blackout the blast chiller/freezer temperature is higher than the high temperature alarm threshold, the following are saved:

- date and time;
- blackout duration;
- blast chiller/freezer temperature after the blackout;
- the type of HACCP alarm (blackout during the conservation phase).

If during the conservation phase the blast chiller/freezer temperature exceeds the high temperature alarm threshold for a time greater than or equal to the high temperature alarm delay time plus the HACCP alarm delay time, as illustrated in Fig. 4.15, the following data are saved:

- date and time;
- duration of the alarm;
- maximum temperature value reached by the blast chiller/freezer;
- type of HACCP alarm (that is, blast chiller/freezer high temperature).

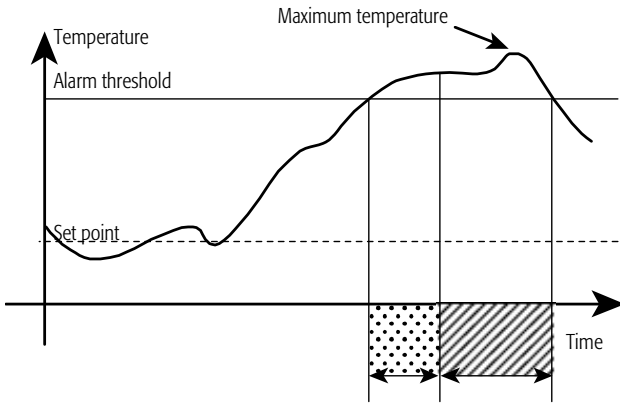

High temperature alarm + HACCP alarm delay



Alarm duration

Fig. 4.15 HACCP high temperature alarm

4.6.1 Using the printer

Blast Chiller can be connected to a printer (RS232 serial port) for printing the data on the last cycles performed and the most recent HACCP alarms. If the device has been correctly configured, a report is printed at the end of each cycle and whenever an HACCP alarm is activated, or more simply whenever the user requires. The hardware requirements for using the serial printer are:

- The printer used must be able to manage a number of columns at least equal to the number on the pCO terminal.
- The printer must have a standard RS232 serial interface.
- For the connection between the printer and the pCO, use the BMS or FieldBus serial port, the latter available on the pCO³ controllers. In addition, the RS232 serial option must be installed on the pCO controllers.
- The printer must support at least one of the communication speeds available on the pCO; 1200, 2400, 4800, 9600 and 19200 bps. The communication settings are: 8 data bits, no parity, 1 stop bit, no flow control.
- The connection cable between the printer and the pCO must be acquired or made according to the signals available on the pCO connector, as follows.

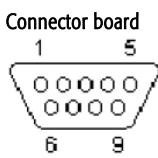

Pin	Name	Direction	Use
1	DCD	Input	Printer error detection. BMS ONLY SERIAL
2	RXD	Input	Data reception
3	TXD	Output	Data transmission
4	DTR	Output	DTR=0 "pCO ready" signals. CONNECTED TO PIN 7 INTERNALLY ON THE BOARD
5	GND	-	Earth pin
7	RTS	Output	CONNECTED TO PIN 4 INTERNALLY ON THE BOARD

Pins 6, 8 and 9 are not connected.

Note: data can be printed corresponding to the last ten cycles completed and to the last ten HACCP alarms activated. The following data are saved (and therefore printed): date, time, type of cycle, value read by the probes at the start and the end of the cycle, duration of the cycle.

4.7 Lights

Input: door switch, brightness sensor, day/night switch.
Parameters: day hours and minutes the light is switched on, day hours and minutes the light is switched off, off time with light sensor, light controlled by the user, light activation during OFF status.
Output: light.

Description of the function:

the light can be controlled by:

- the door open/closed switch,
- the curtain switch,
- the keypad,



Note: the possibility to control the light from the keypad must be set by the manufacturer, otherwise these settings are not visible to the user.

- the supervisor,
- the light sensor,
- the daily time bands.

Control of the lights by the daily time bands can be activated even if Blast Chiller is off, by setting the light activation parameters accordingly.

As concerns the brightness sensors, these can be located inside the blast chiller or on the door frame; in the latter case, they signal when the door is opened by sensing the light. The inside light is therefore switched on when light is detected and off when not. When the brightness sensor is on the other hand located inside the blast chiller, light is also detected when the inside light is on; to overcome this problem, after a time set for the "off time with light sensor" parameter, the inside light is switched off for 5 seconds, so that if no other light is detected, it means that the door is closed and therefore the inside light is kept off, while it remains on if the door is found to be open. If the "off time with light sensor" parameter is set to 0, it means that the sensor is located on the door frame.

4.8 Auxiliary output

Input: activate auxiliary output.

Parameters: day hours and minutes the auxiliary output is activated, day hours and minutes the auxiliary output is deactivated, auxiliary output controlled by the user, auxiliary output activation in OFF status.

Output: auxiliary output.

Description of the function:

the auxiliary output can be controlled by: a digital input, if configured, the keypad, a supervisor and daily time bands. The possibility to control the output from the keypad must be configured by the manufacturer, otherwise the user will not be able to access the settings.

Control by the daily time bands can be activated even if Blast Chiller is off, by setting the "auxiliary output activation in OFF status" parameter accordingly.

4.9 Antifreeze

Input: antifreeze temperature probe.

Parameters: antifreeze temperature alarm threshold, antifreeze alarm delay.

Description of the function:

the antifreeze function is only active if the antifreeze input has been configured. When the antifreeze temperature is lower than the antifreeze temperature alarm threshold for a time equal to the "antifreeze alarm delay", an antifreeze alarm is generated; this alarm immediately stops the compressor and activates the generic alarm output.

4.10 ON/OFF

Parameters: light activation in OFF status, auxiliary output activation in OFF status.

Description of the function:

the ON/OFF status of the Blast Chiller can be managed, with different priorities, by digital input, user interface and the supervisor (the digital input has the highest priority). If the device has been switched off from a digital input, it cannot be switched on in the other ways. On the other hand, the control from the keypad or the supervisor remains enabled if the digital input has not been configured.

During OFF status, the following are disabled:

- running cycles;
- temperature control;
- all the functions relating to the management of the fans and compressors;
- defrost;
- HACCP monitoring;
- saving and displaying the alarms.

In addition, by setting the related parameters, the lights and the auxiliary output can also be enabled or disabled in this status.

During OFF status:

- all the parameters can be displayed and saved;
- the alarms relating to the probes remain active;
- the compressor protection times are observed;
- the pump down procedure is performed (if enabled);
- the defrost and continuous operating modes are terminated.

When switching ON:

- the compressor protection times must be observed;

- the compressor and fan start delays are ignored.

4.11 Sterilisation

Input: door switch.

Parameters: sterilisation duration, maximum sterilisation duration, percentage of power.

Output: sterilisation.

Description of the function:

the sterilisation process can operate in ON/OFF mode or modulating mode, depending on the output configured.

Sterilisation cannot be performed when running a cycle or if the blast chiller door is open, however the operation can be run during the conservation phase.



Note: the value of the sterilisation duration parameter must be less than or equal to the value of the maximum sterilisation duration parameter, set by the manufacturer.

4.12 Heat probe

Input: product temperature.

Parameters: probe heater time, probe heater threshold.

Output: probe heater.

Description of the function:

the heat probe function (piercing probe) cannot be activated if it has not been correctly enabled and the probe is not fitted.

This function, in addition, can only be activated if the temperature measured by the probe in the heart of the product is less than 4 °C. The corresponding digital output remains active until the temperature measured exceeds the set threshold or the maximum duration has been reached.

5 DESCRIPTION OF THE MENUS

Main menu - functions tree

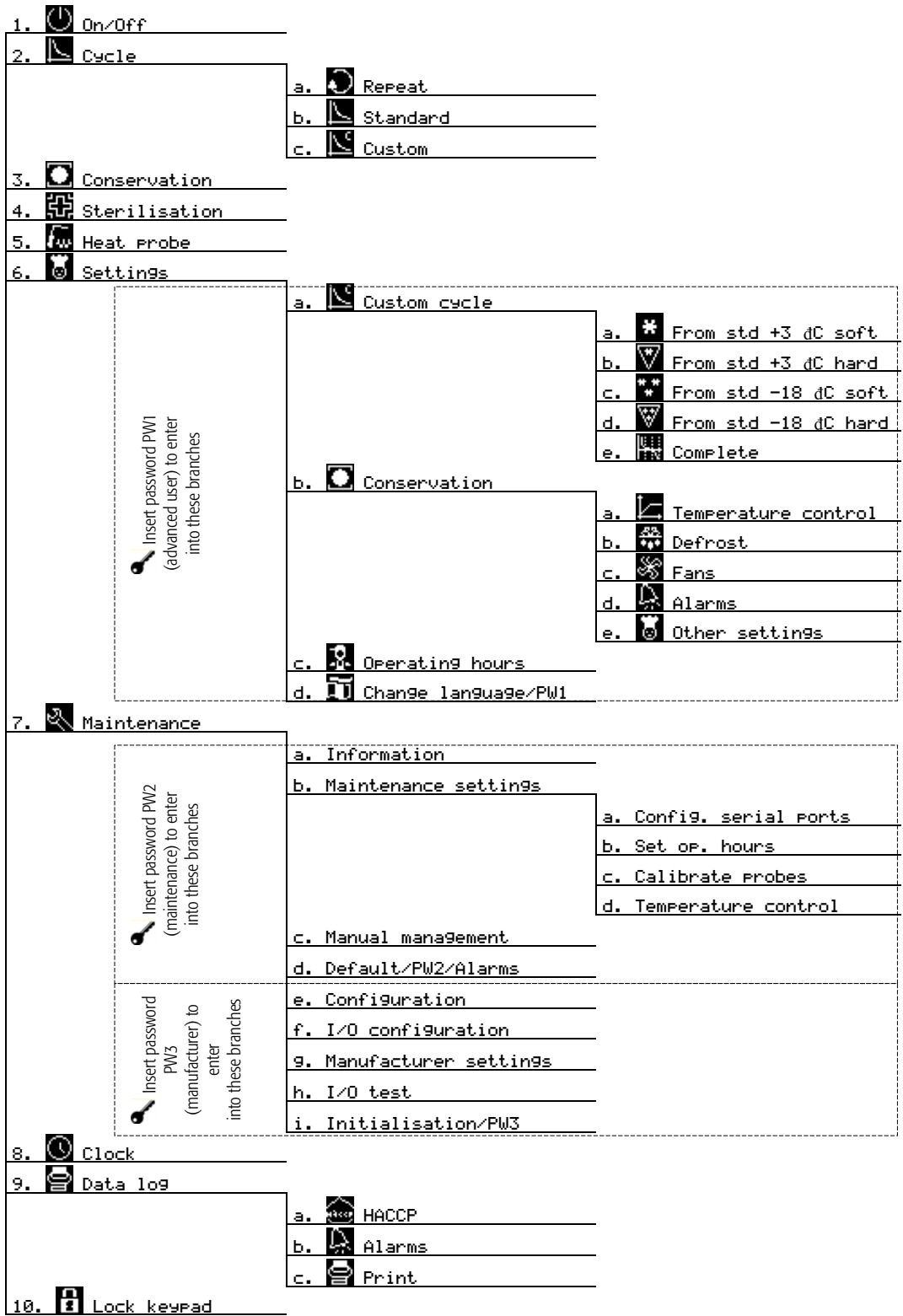

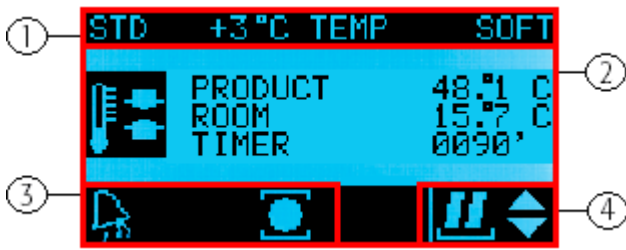

Fig. 5.1

The Blast Chiller screen can be divided into 4 main areas, containing different information:

1	Menu branch accessed by the user, where the address of the screen (relating to the menu map) may be displayed in the top right corner (see Fig. 5.5)
2	Main values relating to the function in question
3	Various information (see the table below)
4	Tools for navigating the Blast Chiller software

Specifically, the bar at the bottom (3) features the following icons:

	Conservation phase set
	Defrost in progress or pending (if flashing)
	Compressors on
	Fans on
	Alarms active
	HACCP alarms active
	Product probe error

The right of the bottom bar (4), on the other hand, contains the following information:

	Start custom cycle
	Stop
	Access auxiliary output control
	Access conservation phase settings
	Access continuous operation
	Access defrost settings and control
	Access light control
	Pause
	Start
	Repeat cycle
	Save
	Access parameter settings
	Start standard cycle

Note: indicates that only one option is available, while is shown if the user can choose between various options available.

5.1 On/Off

This menu is used to switch Blast Chiller on/off, that is, from OFF status to ON and vice-versa. To change status press for 3 seconds.

5.2 Cycle

Used to display the cycle in progress or run a cycle selected from the last completed or the standard or custom cycles set. The Blast Chiller displays the following screen when running a cycle:

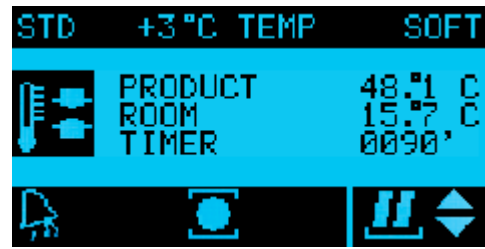

Fig. 5.2

This shows the information on the type of the cycle (by time/by temperature, hard/soft). If, on the other hand, no cycle is running, on accessing this menu three submenus are displayed: REPEAT, STANDARD and CUSTOM; the first row of the display shows the string CYCLE, the various submenus are indicated by specific icons.

5.2.a Repeat

If entering branch 2.a of the functions tree, a screen is displayed showing information on the last cycle completed, with the first row containing the string REPEAT, in the middle is an icon that shows the type of cycle selected and the main variables measured, while the last two rows show the name of the cycle; pressing for 3 seconds starts the cycle and Blast Chiller returns to display the screen shown in Fig. 5.2.

5.2.b Standard

This submenu displays the standard cycles available (loaded as default on Blast Chiller).

Use and to scroll the list of standard cycles, while pressing for 3 seconds starts the cycle displayed at that moment; once the cycle has been started, Blast Chiller returns to the screen shown in Fig. 5.2.

Note: the conservation phase is selected by default for the standard cycle, while the set point is 2 °C.

5.2.c Custom

This submenu describes the various custom cycles (defined by the user, up to a maximum of 10 cycles). Use and to scroll the list of custom cycles, while pressing for 3 seconds starts the cycle displayed at that moment; once the cycle has been started, Blast Chiller returns to the screen shown in Fig. 5.2.

5.3 Conservation

This menu can be used to start or modify the conservation phase. The screen displayed is similar to the one shown in Fig. 5.2, and is used to set the main parameters.

5.4 Sterilisation

Access this menu to start the blast chiller sterilisation procedure. The display shows the screen in Fig. 5.3 (this screen is only visible, however, if the corresponding output has been enabled, otherwise the display shows the message NOT AVAILABLE).



Fig. 5.3

The first row shows the string STERILISATION, while in the middle of the screen are the temperature of the blast chiller and the duration of the sterilisation process. The icon flashes if the process is running. The last two rows focus the user's attention on any causes that prevent the sterilisation process from starting or other information concerning the end of the procedure. The icons at the bottom right are used to start/stop the sterilisation process (pressing for 3 seconds) and change its duration.

At the end of the process, the last two rows of the display show a message telling the user that operation is complete (STERILISATION COMPLETED) and, pressing **menu** or **Esc**, Blast Chiller returns to the main menu. If for any reason the sterilisation procedure was not completed correctly (for example, if the door of the blast chiller is opened during the procedure), the last two rows of the display show the string

STERILISATION NOT COMPLETED. If, while sterilisation is running, the user returns to the main menu, but wants to know the status of the process, simply return to the corresponding menu.

Note: pressing **menu** or **ESC** and thus returning to the main menu cancels all the information relating to the end of the sterilisation process.

5.5 Heat probe

This menu is used to access the heat probe function (piercing probe); the screen is however only visible if the corresponding function has been enabled (otherwise the display shows NOT AVAILABLE).

The icon on the display flashes if heating is in progress, while the last two rows of the display inform the user when the temperature has reached the set threshold or if necessary show a message that indicates the reason why the probe did not start heating. The operation of this menu is similar to the previous one (Sterilisation).

5.6 Settings

The Settings menu accesses the pages of the functions available only to advanced users; in fact, to access this menu a password needs to be entered (PW1). Remember that some screens are only displayed if the corresponding functions are available.

The menu shows SETTINGS at the top and four submenus in the middle: a. Custom cycle, b. Storage, c. Operating hours and d. Change language, which correspond to four icons.

5.6.a Custom cycle

This submenu is used to define a custom cycle. First of all the user can choose the standard cycle to use as the basis for creating the custom cycle:

- 6.a.a From std +3 °C soft
- 6.a.b From std +3 °C hard
- 6.a.c From std -18 °C soft
- 6.a.d From std -18 °C hard
- 6.a.e Complete (that is, three phases).

The two basic cycles 6.a.a and 6.a.d both contain the parameters for the cycle with just one phase; the parameters can be set using **↑** and **↓** (to increase or decrease the values), and the values must be confirmed by pressing **←**. Once the value of the parameter has been set, the cursor automatically moves to the next parameter, and after having set the last parameter, the screen for saving the custom cycle is displayed. The same thing occurs when selecting the two cycles 6.a.b and 6.a.c (two phases), however there are more parameters (those relating to the second phase). Selecting a complete cycle, that is, with three phases, the procedure to configure the custom cycle is the same, only longer as there are even more parameters to set. In each step the last row of the display shows a string that describes the phase corresponding to the parameter being set at that moment.

Note: the name used to save the custom cycles can have a maximum of 15 characters. The characters are selected by scrolling the list (in alphabetical order) using **↑** and **↓** and then confirming the character with **←**; once the required name has been set, press **←** for 3 seconds to save it. Confirmation (CYCLE SAVED, PRESS MENU FOR THE MAIN MENU) tells the user that the cycle has been saved.

Note: pressing **ESC** at any time returns to the previous step.

Note: if the negative temperature cycles are disabled, only submenus 6.a.a and 6.a.b are available.

5.6.b Conservation

This menu is used to configure all the parameters relating to the conservation phase. In the same way as described for menu 6 (Settings), the top of the display shows the string CONSERVATION, while in the middle are four submenus:

- 6.b.a Temperature control
- 6.b.b Defrost
- 6.b.c Fans
- 6.b.d Alarms

When entering each of these submenus, the various parameters can be set in the same way as in the previous menus (using **↑** and **↓** to choose the various values and confirming by pressing **←**, while pressing **ESC** at any time returns to the previous step).

Note: on the page for setting the parameters, the first row of the display shows the name of the submenu relating to the parameter being set, as shown in Fig. 5.4.



Fig. 5.4

5.6.c Operating hours

This shows the operating hours of all the main devices connected to Blast Chiller, so as to monitor periodical maintenance.

↑ and **↓** scroll the list of the various devices, while **ESC** returns to the higher level menu.

5.6.d Change language

The user can select one of the languages loaded in the Blast Chiller memory; in addition, the unit of measure can be chosen, between SI (international system) and Imperial (temperature expressed in °C or in °F and the date expressed as dd/mm/yy or yy/mm/dd).

The other function available in this menu is the possibility to change password PW1. The screen is navigated in the same way as described for the other screens.

5.7 Maintenance

The menu can only be accessed when entering a password; depending on the password entered and the access level, different screens will be displayed:

- password PW2: accesses the maintenance level screens only;
- password PW3: accesses all the screens on the Blast Chiller (manufacturer level).

Some screens are displayed only if the corresponding function is available.

The main feature of the maintenance menu screens (7) is that the first row of the display, on the right, shows the address of the screen, with reference to the map of the functions tree described above.

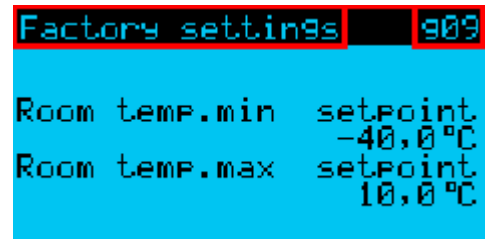

Fig. 5.5

Note: Fig. 5.5 shows an example of the reference to the Blast Chiller screen map: "ba01" in fact indicates that inside the menu, after having chosen branch "b" and sub-branch "a", the user has accessed the screen for configuring the serial port.

5.7.a Information

This menu shows information on the hardware and the firmware and software versions.

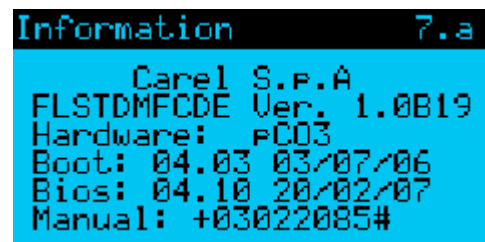

Fig. 5.6

5.7.b Maintenance settings

This branch includes the following functions:

- 7.b.a Config. serial ports: used to set all the parameters required for connection to the supervisory system, which depend on the type of optional board and connection protocol selected.
- 7.b.b Set op. hours: used to select the various time thresholds for the planned maintenance of the various devices.

- 7.b.c Calibrate probes: used to set the offset to be added to/subtracted from the value read by the probe, so as to give a more accurate indication of the temperature acquired.
- 7.b.d Temperature control: features the parameters relating to temperature control; these can be modified when starting or during the maintenance of Blast Chiller, except those covered by the manufacturer access level (password PW3).

once the keypad has been locked, it can only be unlocked by entering one of the three passwords, PW1, PW2 or PW3.

5.7.c Manual management

Used to switch from automatic to manual operating mode for each device connected to the Blast Chiller.

The digital outputs can be ON or OFF, while for the analogue outputs the percentage can be selected. The default values are Auto.

Manual operating manual ignores temperature control, but not the thresholds for the various alarms, so as to guarantee the safety of the system. This mode is usually used to test the operation of the individual devices, or to set a preset value for a certain output.

5.7.d Default/PW2/Alarms

Used to set the default values for the manufacturer parameters, therefore cancelling all the custom settings and rebooting Blast Chiller with the default settings. This screen can also be used to change password PW2 and delete the data relating to the alarms that have been saved.

5.7.e Configuration

To select all the main functions of the Blast Chiller, such as the operation of each device or whether or not the various components and accessories are fitted.

5.7.f I/O configuration

In this menu the functions can be set for each individual I/O channel; for each input or output, a connected probe or device can be selected. Once a probe or a device has been selected and assigned to the respective input or output, it can no longer be selected. For the digital I/Os, the type of device can also be set (NO or NC); for the analogue outputs, the maximum and minimum values can be set, while for the digital inputs the type of probe and the operating range can be configured.

5.7.g Manufacturer settings

Used to select and set the parameters that can be configured by the manufacturer.

5.7.h I/O test

Used to check the status and the operation of the input and output channels.

5.7.i Initialisation/PW3

This screen is used to restore the default parameter values (set by CAREL); choosing "CAREL default" cancels all the custom settings made and reboots Blast Chiller, restoring with the initial settings.

In addition, password PW3 can be changed.

5.8  Clock

This menu is used to set the date and time of the Blast Chiller clock.



Note: the type of date and time display may be selected using the corresponding parameter.

5.9  Data log

The data log menu is used to access the list of HACCP alarms, the other alarms and print the HACCP reports. This screen in fact features three submenus:

- 9.a HACCP: displays the HACCP alarms;
- 9.b Alarms: displays all the other alarms;
- 9.c Print: used to print the last ten HACCP alarms and the last ten cycles completed.

5.10  Lock keypad







Used to lock/unlock the keypad. To lock/unlock the keypad, press **Esc** and  together. To prevent unauthorised personnel from changing the Blast Chiller settings,

6 TABLE OF PARAMETERS

The following table shows all the parameters, divided by the functions they refer to; the columns in the table show:

- Parameter: the name of the parameter;
- Type: indicates the function the various parameters relate to;
- Screen: the identification number of the screen for accessing the parameter in question (menu branch followed by the index of the screen, if available);
- Description: short description of the parameter;
- UOM: unit of measure;
- Range: the range of values available for the parameter;
- Default: the default value of the parameter.

Key to the type of parameters (main)

	Defrost
	Cycle and custom cycle
	Fans
	HACCP alarms
	Alarms
	Temperature control and compressors
	Inputs/outputs

Parameter	Type	Menu, screen	Description	UOM	Range	Default
Cycle						
Current cycle		-	Cycle running	-	...	-
Product temperature		-	Product temperature (the highest or the average value if more than one probe is used, depending on the value set for the blast chiller temp. probe management)	° C	-50.0 to +90.0	-
Blast chiller/freezer temperature		-	Blast chiller/freezer temperature (the highest or the average value if more than one probe is used, depending on the value set for the blast chiller temp. probe management)	° C	50.0 to +90.0	-
Timer		-	Time remaining until the conclusion of the cycle	min	-maximum cycle duration to 9999	-
Signals		-	Alarms, HACCP alarms, product probe error, conservation phase setting	-	to	-
Cycle status		-	Information concerning the end of the cycle	-	Cycle terminated correctly, cycle terminated after maximum time	-

Conservation

Blast chiller/freezer temperature		-	Blast chiller/freezer temperature (the highest or the average value if more than one probe is used, depending on the value set for the blast chiller temp. probe management parameter blast chiller)	° C	-50.0 to +90.0	-
Set point		-	Blast chiller/freezer temperature set point	° C	minimum blast chiller/freezer temperature set point to maximum blast chiller/freezer temperature set point	-
Signals		-	Alarms, HACCP alarms, product probe error, conservation phase setting, defrost, fans, compressors	-	to	-
Light activation			Activation of the light	-	Off, On	Off
Evaporator temperature		-	Evaporator temperature	° C	-50.0 to +90.0	-
End defrost threshold		-	End defrost threshold	° C	-50.0 to +90.0	+4.0
Defrost timer		-	Time remaining until the conclusion of the defrost	min	maximum defrost duration to 0	-
Continuous operating mode duration		-	Continuous operating mode duration set point	min	0 to 9999	480
Continuous operating mode timer		-	Time remaining until the conclusion of the continuous operating mode	min	0 to 9999	480
Set point		-	Evaporator set point temperature	° C	-50.0 to +90.0	+2.0

On-Off-  main menu

Unit status		1.	Unit status	-	ON, OFF from supervisor, OFF from keypad, OFF from digital input, OFF from alarm	Off
-------------	---	----	-------------	---	--	-----

Cycle -  main menu

Current cycle		2.a	Last cycle completed	-	to	-
---------------	---	-----	----------------------	---	----	---

Product temperature	2.a	Blast chiller/freezer temperature (the highest or the average value if more than one probe is used, depending on the value set for the blast chiller temp. probe management parameter blast chiller)	° C	-50.0 to +90.0	-
Blast chiller/freezer temperature	2.a	Blast chiller/freezer temperature (the highest or the average value if more than one probe is used, depending on the value set for the blast chiller temp. probe management parameter blast chiller)	° C	50.0 to +90.0	-
Timer	2.a	Duration of the last cycle completed	min	0 to 9999	-
Standard cycles	2.b	Standard cycles	-	1 to 8	1
Custom cycles	2.c	Custom cycles	-	1 to 10	1

Conservation -  main menu

Product temperature	3.	Blast chiller/freezer temperature (the highest or the average value if more than one probe is used, depending on the value set for the blast chiller temp. probe management parameter blast chiller)	° C	-50.0 to +90.0	-
Blast chiller/freezer temperature	3.	Blast chiller/freezer temperature (the highest or the average value if more than one probe is used, depending on the value set for the blast chiller temp. probe management parameter blast chiller)	° C	50.0 to +90.0	-
Set point	3.	Blast chiller/freezer temperature set point	° C	minimum blast chiller/freezer temperature set point to maximum blast chiller/freezer temperature set point	-
Signals	3.	Alarms, HACCP alarms, product probe error, conservation phase setting, defrost, fans, compressors	-	to	-

Sterilisation -  main menu

Output	4.	Value of the sterilisation analogue output	%	0 to 100	0
Blast chiller/freezer temperature	4.	Blast chiller/freezer temperature (the highest or the average value more than one probe is used, depending on the value set for the blast chiller temp. probe management parameter blast chiller)	° C	50.0 to +90.0	-
Timer	4.	Time remaining until the conclusion of the sterilisation process	min	0 to maximum sterilisation duration	100
Sterilisation status	4.	Sterilisation status	-	Door open, sterilisation completed, sterilisation not completed, ...	-
Sterilisation duration	4.	Sterilisation duration set point	min	0 to maximum sterilisation duration	20
Output	4.	Sterilisation analogue output set point	%	0 to 100	0%
Sterilisation duration	4.	Sterilisation duration	min	0 to maximum sterilisation duration	1000

Heat probe -  main menu







Product temperature	5.	Product temperature (the highest or the average value if more than one probe is used, depending on the value set for the blast chiller temp. probe management parameter blast chiller)	° C	-50.0 to +90.0	-
Probe heating status	5.	Probe heating status	-	Probe heating completed, temperature in the heart too high, ...	-

Settings -  main menu

Password	6.	User password	-	0 to 9999	1234
End cycle	6.a.a	Select type of end cycle	-	temperature, time	Temperature (*)
Blast chiller set point	6.a.a	Blast chiller temperature set point	° C	minimum blast chiller/freezer temperature set point to maximum blast chiller/freezer temperature set point	0.0 (*)
Product set point	6.a.a	Product set point temperature, if the cycle finishes by time, this value is ignored	° C	minimum product set point temperature to maximum product set point temperature	+3.0 (*)
Phase duration	6.a.a	Duration of the cycle, if the cycle finishes by temperature, this is the maximum duration of the cycle	min	0 to maximum cycle duration	90 (*)
Conservation	6.a.a	Conservation phase set after the cycle ends	-	NO/YES	YES (*)
Cons. set point	6.a.a	Blast chiller/freezer temperature set point during the conservation phase	° C	minimum blast chiller/freezer temperature set point to maximum blast chiller/freezer temperature set point	+2.0 (*)
Defrost before cycle	6.a.a	Defrost set before running the cycle	-	NO/YES	YES (*)
Defrost before cons.	6.a.a	Defrost set before the conservation phase	-	NO/YES	YES (*)









Custom cycle number	6.a.a	Number of the custom cycle to be saved	-	1 to 10	1 (*)
Custom cycle name	6.a.a	Name of the custom cycle (15 fields)	-	A to Z, a to z, 0 to 9, , , - , +	-







 **Note:** Blast Chiller features the same mode for setting the custom cycle parameters for all three phases (shown above);
 (*) the default values change for each phase shown on the individual screen during the creation of a cycle.

Conservation set point		6.b.a	Blast chiller/freezer temperature set point in conservation	° C	minimum blast chiller/freezer temperature set point to maximum blast chiller/freezer temperature set point	+2.0
Defrost scheduler		6.b.b	Type of defrost scheduler	-	0: not used 1: start conservation + time between defrost 2: time set + time between defrost 3: time set	1
Day		6.b.b	Day of activation of the first defrost	-	Monday to Sunday, Mon. to Fri., Mon. to Sat., weekends	-
Time of the first defrost		6.b.b	Hours and minutes of the first defrost. The next will be run after the "time between defrosts" or at the time set for the second defrost, according to the settings of the "defrost scheduler" parameter	...	0 to 23 0 to 59	0 0
...	
Time of the eighth defrost		6.b.b	Hours and minutes of the eighth defrost	...	0 to 23 0 to 59	0 0
Evap. fan control set point		6.b.c	Evaporator fan control set point. Parameter active only if the fans are controlled in relation to the temperature, that is, depending on the deviation between the blast chiller/freezer temperature and the evaporator temperature	° C	Minimum fan control set point to Maximum set point control fans	5.0
D. switch fans off		6.b.c	Fans off when door closed	-	YES/NO	YES
Fans during defrost		6.b.c	Fans during defrost	-	Off, On	On
Type of HACCP threshold		6.b.d	Type of HACCP alarm threshold	-	Relative / Absolute	Relative
High temp. alarm threshold		6.b.d	HACCP high temperature alarm threshold	° C	Minimum HACCP high temperature alarm threshold to Maximum HACCP high temperature alarm threshold	5.0
HACCP temp. alarm delay		6.b.d	HACCP high temperature alarm delay	s	0 to 9999	120
Day		6.b.e	Day light first switched	...	Monday to Sunday, Mon. to Sat. 0 to 23 0 to 59	Monday 0 0
First start time		6.b.e	Day, hours and minutes light switched on	...	0 to 23 0 to 59	Monday 0 0
First end time		6.b.e	Day, hours and minutes light switched off	...	0 to 23 0 to 59	Monday 0 0
...		to	to
First start time		6.b.e	Day, hours and minutes light switched on	...	0 to 23 0 to 59	Monday 0 0
Fourth end time		6.b.e	Day, hours and minutes light switched off	...	0 to 23 0 to 59	Monday 0 0
First start time		6.b.e	Day, hours and minutes auxiliary output activated	...	0 to 23 0 to 59	Monday 0 0
First end time		6.b.e	Day, hours and minutes auxiliary output deactivated	...	0 to 23 0 to 59	Monday 0 0
Compressor		6.c	Compressor op. hours	h	0 to 30000	-
Control in:		6.c	Time remaining before next compressor control	h	0 to 30000	30000
Compressor 2		6.c	Second compressor op. hours	h	0 to 30000	-
Control in:		6.c	Time remaining before next second compressor control	h	0 to 30000	30000
Evap. fan		6.c	Evaporator fan op. hours	h	0 to 30000	-
Control in:		6.c	Time remaining before next evaporator fan controls	h	0 to 30000	30000
Cond. fan		6.c	Condenser fan op. hours	h	0 to 30000	-
Control in:		6.c	Time remaining before next condenser fan control	h	0 to 30000	30000
UV light		6.c	UV light op. hours	h	0 to 30000	-
Control in:		6.c	Time remaining before next UV light control	h	0 to 30000	30000
Unit		6.c	Op. hours unit	h	0 to 30000	-













Control in:		6.c	Time remaining before next unit control	h	0 to 30000	30000
Change language		6.d	Change the language of the user interface	-	English, French, Italian, German, Spanish	English
Show screen when starting		6.d	Enable display of the change language screen at start-up	-	NO/YES	YES
Change language in:		6.d	Delay time within which the change of language is accepted without modifications	s	0 to 9999	60
Unit of measure		6.d	Change temperature unit of measure	-	°C/ °F	°C
Date setting		6.d	Change the date settings	-	dd/mm/yy, mm/dd/yy	dd/mm/yy
Enable buzzer		6.d	Enable the buzzer	-	N/ Y	Y
New PSW		6.d	Change the user password	-	0 to 9999	1234

Maintenance -  main menu

Enter password		7.a	Maintenance or manufacturer password	-	0 to 9999	1234, 1234
Type of board		7.a	Type of hardware	-	pCO ³ , pCO ⁶	-
Boot		7.a	Boot version	-	...	-
Bios		7.a	Bios version	-	...	-
BMS protoc.		7.b.a, ba02	Protocol used on the BMS port	-	Carel, ModBus, LON, Carel RS232, printer	printer
BMS address		7.b.a, ba02	Address for the supervisory system	-	1 to 200	1
BMS speed		7.b.a	Communication speed of the BMS serial port	bps	1200, 2400, 4800, 9600, 19200	19200
Field Bus protocol		7.b.a	Protocol used for the Field Bus serial port	-	Carel, ModBus, Carel RS232, printer	Carel
Field Bus speed		7.b.a	Select the communication speed of the Field Bus serial port	bps	1200, 2400, 4800, 9600, 19200	19200
Compressor op. hour threshold		7.b.b, bb01	Compressor op. hour threshold	h	0 to 30000	30000
Reset compressor op. hours		7.b.b, bb01	Reset compressor op. hours	-	NO/YES	NO
Compressor 2 op. hour threshold		7.b.b, bb02	Second compressor op. hour threshold	h	0 to 30000	30000
Reset compressor 2op. hours		7.b.b, bb02	Reset second compressor op. hours	-	NO/YES	NO
Evap. fan op. hour threshold		7.b.b, bb03	Evaporator fan op. hour threshold	h	0 to 30000	30000
Reset evap. fan op. hours		7.b.b, bb03	Reset evaporator fan op. hours	-	NO/YES	NO
Cond. fan op. hour threshold		7.b.b, bb04	Condenser fan op. hour threshold	h	0 to 30000	30000
Cond evap. fan op. hours		7.b.b, bb04	Reset condenser fan op. hours	-	NO/YES	NO
UV light op. hour threshold		7.b.b, bb05	UV light op. hour threshold	h	0 to 30000	30000
Reset UV light op. hours		7.b.b, bb05	Reset UV light op. hours	-	NO/YES	NO
Unit op. hour threshold		7.b.b, bb06	Unit op. hour threshold	h	0 to 30000	30000
Reset unit op. hours		7.b.b, bb06	Reset unit op. hours	-	NO/YES	NO
Probe B1 offset		7.b.c, bc01	Offset in the reading of probe B1	°C	-9.9 to +9.9	0.0
...		7.c
Probe B5 offset		7.b.c, bc03	Offset in the reading of probe B5	°C	-9.9 to +9.9	0.0
Blast chiller/freezer temperature diff.		7.b.d, bd01	Blast chiller/freezer temperature diff.	°C	0.0 to 90.0	2.0
Device connected to digital output 1		7.c, c01	Device connected to digital output 1	-	See Chap. 9 CONFIGURATIONS	compressor
Operating mode		7.c, c01	Operating mode of digital output 1	-	Auto, Manual	Auto
Digital output 1 in manual operating mode		7.c, c01	Digital output 1 in manual operating mode	-	On/ Off	Off
...	
Device connected to digital output 8		7.c, c08	Device connected to digital output 8	-	See Chap. 9 CONFIGURATIONS	defrost
Operating mode		7.c, c08	Operating mode of digital output 8	-	Auto, Manual	Auto
Digital output 8 in manual operating mode		7.c, c08	Digital output 8 in manual operating mode	-	On/ Off	Off
Device connected to analogue output 1		7.c, c09	Device connected to analogue output 1	-	See Chap. 9 CONFIGURATIONS	Steril.
Operating mode of analogue output 1	7.c, c09	Operating mode of analogue output 1	-	Auto, Manual	Auto	

Analogue output 1 in manual operating mode		7.c, c09	Analogue output 1 in manual operating mode	%	0 to 100	0
Device connected to analogue output 3		7.c, c11	Device connected to analogue output 3	-	See Chap. 9 CONFIGURATIONS	-
Operating mode of analogue output 3		7.c, c11	Operating mode of analogue output 3	-	Auto, Manual	Auto
Analogue output 3 in manual operating mode		7.c, c11	Analogue output 3 in manual operating mode	%	0 to 100	0
Manufacturer default		7.d	Reset the manufacturer default settings	-	NO/YES	NO
New maintenance password		7.d	New maintenance password	-	0 to 9999	1234
Reset alarms		7.d	Reset the data for the alarms saved	-	NO/YES	NO
Number of compressors		7.e, e01	Number of compressors managed	-	0 to 2	1
Compressor parallel op.		7.e, e01	Enable parallel compressor operating mode in		NO/YES	NO
Enable compressor rotation		7.e, e01	Enable compressor rotation	-	NO/YES	NO
Type of evaporator fan control		7.e, e02	Type of evaporator fan control	-	0: not used 1: none 2: on evaporator temperature 3: on temperature diff.	None
Printer fitted		7.e, e04	Printer fitted	-	NO/YES	NO
DCD manual status		7.e, e05	Status of the DCD manual signal	-	NO/YES	NO
Err. control		7.e, e05	Disable print error control	-	NO/YES	YES
Man. error reset		7.e, e05	Manual print error reset	-	NO/YES	NO
Remove empty lines		7.e, e06	Remove empty lines by the print	-	NO/YES	NO
Disable print queue		7.e, e06	Disable print queue	-	NO/YES	NO
User light contr.		7.e, e07	Enable light control by the user	-	NO/YES	NO
User output contr.		7.e, e07	Enable auxiliary output control by the user	-	NO/YES	NO
Config. dig. input 1		7.f, f01	Device connected to digital input 1	-	See Chap. 9 CONFIGURATIONS	On/Off
Relay logic		7.f, f01	Logic of digital input 1	-	NO, NC	NO
...		7.f
Config. dig. input 8		7.f, f08	Device connected to digital input 8	-	See Chap. 9 CONFIGURATIONS	High press.
Relay logic		7.f, f08	Logic of digital input 8	-	NO, NC	NC
Conf. an. input1		7.f, f09	Device connected to analogue input 1	-	See Chap. 9 CONFIGURATIONS	Blast chiller temp. 1
Type		7.f, f09	Type of probe 1	-	--, 4 to 20 mA, 0 to 10 V, NTC, PT1000, to	NTC
Min. value		7.f	Minimum value of probe 1	°C	-99.9 to 99.9	0.0
Max. value		7.f	Maximum value of probe 1	°C	-99.9 to 99.9	0.0
...		7.f	to	to
Conf. an. input5		7.f, f14	Device connected to analogue input 5	-	See Chap. 9 CONFIGURATIONS	Antifreeze temp.
Type		7.f, f14	Type of probe 5	-	--, 4 to 20 mA, 0 to 10 V, NTC, PT1000, to	NTC
Min. value		7.f, f14	Minimum value of probe 5	°C	-99.9 to 99.9	0.0
Max. value		7.f, f14	Maximum value of probe 5	°C	-99.9 to 99.9	0.0
Config. Dig. output 1		7.f, f15	Device connected to digital output 1	-	See Chap. 9 CONFIGURATIONS	compressor
Relay logic		7.f, f15	Logic of digital output 1	-	NO, NC	NO
...		7.f
Config. Dig. output 8		7.f, f22	Device connected to digital output 8	-	See Chap. 9 CONFIGURATIONS	defrost
Relay logic		7.f, f22	Logic of digital output 8	-	NO, NC	NO
Config. analogue output. 1		7.f, f23	Device connected to analogue output 1	-	See Chap. 9 CONFIGURATIONS	sterilisation
Min. value		7.f, f23	Minimum value of analogue output 1	%	0.0 to 100.0	0.0
Max. value		7.f, f23	Maximum value of analogue output 1	%	0.0 to 100.0	100.0
...		7.f
Analogue output 3		7.f, f25	Device connected to analogue output 3	-	See Chap. 9 CONFIGURATIONS	Cond. fan
Min. value		7.f, f25	Minimum value of analogue output 3	%	0.0 to 100.0	0.0
Max. value		7.f, f25	Maximum value of analogue output 3	%	0.0 to 100.0	100.0
Blast chiller temp. calculation		7.g, g01	Calculate blast chiller/freezer temperature when multiple probes used	-	Average, highest	Average
Prod. temp. calculation		7.g, g01	Calculate product temperature when multiple probes used	-	Average, highest	Average

Type	7.g, g02	Type of blast chiller/freezer temperature threshold	-	Relative, absolute	Relative
Enable high temp. al.	7.g, g03	Enable high temperature alarm	-	NO/YES	YES
High temp. al. threshold	7.g, g03	High temperature alarm threshold	°C	-50.0 to 90.0	5.0
High temp. al. delay	7.g, g03	High temperature alarm delay	s	0 to 9999	0
Enable low temp. al.	7.g, g04	Enable low temperature alarm	-	NO/YES	YES
Low temp. al. threshold	7.g, g04	Low temperature alarm threshold	°C	-50.0 to 90.0	3.0
Low temp. al. delay	7.g, g04	Low temperature alarm delay	s	0 to 9999	0
High temp. al. delay after defrost	7.g, g05	High temperature alarm delay after defrost	s	0 to 9999	30
High temp. al. delay after open door	7.g, g05	High temperature alarm delay after opening door	s	0 to 9999	30
Antifreeze alarm threshold	7.g, g06	Antifreeze alarm threshold	°C	-50.0 to 90.0	-25.0
Antifreeze alarm delay	7.g	Antifreeze alarm delay	s	0 to 9999	30
External al. delay	7.g, g07	External alarm delay	s	0 to 9999	30
Low press. al. delay start	7.g, g07	Low pressure alarm delay when starting	s	0 to 9999	30
Low press. al. delay steady	7.g, g07	Low pressure alarm delay in steady operation	s	0 to 9999	30
High cond. temp. threshold	7.g, g08	High condenser temperature alarm threshold	°C	-50.0 to 90.0	40.0
High cond. temp. differential	7.g, g08	High condenser temperature alarm differential	°C	-50.0 to 90.0	4.0
High cond. temp. al. delay	7.g, g08	High condenser temperature alarm delay	s	0 to 9999	30
Min. blast chiller temp. setp.	7.g, g09	Minimum blast chiller/freezer temperature set point	°C	-99.9 to 99.9	-40.0
Max. blast chiller temp. setp.	7.g, g09	Maximum blast chiller/freezer temperature set point	°C	-99.9 to 99.9	10.0
Min. product temp. setp.	7.g, g10	Minimum product temperature set point	°C	-99.9 to 99.9	-40.0
Max. product temp. setp.	7.g, g10	Maximum product temperature set point	°C	-99.9 to 99.9	10.0
Set point delta with day/night switch	7.g, g11	Set point variation with day/night switch	°C	0.0 to 90.0	2.0
Diff. delta with day/night	7.g, g11	Differential variation with day/night switch	°C	0.0 to 90.0	1.0
Min. evap. fan. setp.	7.g, g12	Minimum evaporator fan control set point	°C	-50.0 to 90.0	0.0
Max. evap. fan. setp.	7.g, g12	Maximum evaporator fan control set point	°C	-50.0 to 90.0	50.0
Evap. fan diff.	7.g, g13	Evaporator fan control differential. Parameter active only if fans controlled according to the temperature	°C	0.0 to 90.0	2.0
Fan speed up time	7.g, g13	Fan speed up time	s	0 to 999	0
Min. HACCP temp. setp.	7.g, g14	Minimum HACCP high temperature set point	°C	-50.0 to 90.0	2.0
Max. HACCP temp. setp.	7.g, g14	Maximum HACCP high temperature set point	°C	-50.0 to 90.0	5.0
HACCP alarm delay	7.g, g14	HACCP temperature alarm delay	min	0 to 9999	120
Blackout duration during cycle	7.g, g15	Allowing duration of HACCP blackout when running a cycle	min	0 to 9999	5
Blackout duration during conservation	7.g, g15	Allowing duration of HACCP blackout during the conservation phase	min	0 to 9999	1
Door open duration during cycle	7.g, g16	Allowing duration of door open when running a cycle	s	0 to 9999	30
Pause duration during cycle	7.g, g16	Allowing pause duration when running a cycle	s	0 to 9999	30
Probe out-of-range delay	7.g, g17	Time in which the probe error is ignored before a cycle	min	0 to 9999	5
Probe not inserted differential	7.g, g17	Differential for control probe not inserted	°C	0.0 to 20.0	3.0
Sample time	7.g, g17	Time for checking incorrect probe insertion and product overload	min	0 to 9999	5
Type of defrost	7.g, g18	Type of defrost	-	0: not used 1: temperature, with heater 2: temperature, with gas 3: time, with heat. 4: time, with gas 5: temp. con. w/ heat. 6: manual	-
Start defrost t.	7.g, g18	Start defrost threshold set point	°C	-50.0 to 90.0	-3.0
End defrost t.	7.g, g18	End defrost threshold set point	°C	-50.0 to 90.0	4.0
Defrost activation delay	7.g, g19	Start defrost delay after reaching the threshold	s	0 to 9999	180
Defrost delay output	7.g, g19	Defrost output activation delay	s	0 to 9999	10
Min. time between def.	7.g, g20	Minimum time between different defrosts	min	0 to 480	30
Min. defrost duration	7.g, g20	Minimum defrost duration	s	0 to 9999	120
Max. defrost duration	7.g, g20	Maximum defrost duration	min	0 to 480	10



Time between defrosts		7.g, g21	Time between different defrosts	h	0 to 999	8
Dripping time		7.g, g21	Dripping duration	s	0 to 9999	120
Post-Dripping time		7.g, g21	Fan off time after dripping	min	0 to 15	1
Comp. prot. priority over def.		7.g, g22	Compressor protection or defrost priority	-	Comp. , Defrost	Comp.
Defrost differential with temperature control		7.g, g22	Temperature controlled defrost differential	° C	0.0 to 90.0	2.0
Advanced defrosts		7.g, g23	Type of advanced defrost	-	0: not used 1: none 2: variable time 3: skip defrost 4: variable time + skip	None
Nominal defrost		7.g, g23	Nominal defrost duration	%	0 to 100	65
Prop. factor		7.g, g23	Proportional factor in defrost duration	%	0 to 100	50
Min. compressor on time		7.g, g24	Minimum compressor time on	s	0 to 9999	60
Min. compressor off time		7.g, g24	Minimum compressor off time	s	0 to 9999	180
Minimum time between starts of same compressor		7.g, g24	Minimum time between compressor starts	s	0 to 9999	360
Comp. and fan start delay at on		7.g, g25	Initial delay in starting compressor and fans	s	0 to 9999	60
Phase 2 delay		7.g, g25	Minimum time between starts of different compressors	s	0 to 9999	180
Comp. off with door		7.g, g25	Compressor behaviour with door open	-	On, Off	On
Door stop delay		7.g, g25	Delay after which compressors and fans start again with door open	s	0 to 9999	360
Duty setting on time		7.g, g26	Duty setting on time	min	0 to 9999	5
Duty setting off time		7.g, g26	Duty setting off time	min	0 to 9999	10
Continuous operation time		7.g, g27	Continuous operating mode duration	min	0 to 9999	480
Low temp. delay after continuous op.		7.g, g27	Low temperature delay after continuous operating mode	s	0 to 9999	30
Enable pump down		7.g, g28	Enable pump down	-	NO/YES	NO
P. down valve and comp. delay		7.g, g28	Pump down valve and compressor delay	s	0 to 9999	30
End pump down		7.g, g29	Select type of end pump down	-	By time, by press.	By time
Compressor auto start during pump down		7.g, g29	Enable auto start compressor during pump down	-	NO/YES	NO
Max. pump down time		7.g, g29	Maximum pump down duration	min	0 to 9999	5
Comp. on time with generic alarm		7.g, g30	Compressor operating time with generic alarm	min	0 to 9999	5
Comp. off time with generic alarm		7.g, g30	Compressor off time with generic alarm	min	0 to 9999	10
Evap. fan with comp. off		7.g, g31	Evaporator fan behaviour with compressor off	-	Always on, on with comp.	Always on
Cond. fan setp.		7.g, g31	Temperature set point to stop condenser fans	° C	-50.0 to 90.0	35.0
Cond. fan diff.		7.g, g31	Temperature differential to stop condenser fans	° C	0.0 to 90.0	2.0
Min. phase control		7.g, g32	Minimum phase shift for PWM output	%	0 to 100	25
Max phase control		7.g, g32	Massimo phase shift for PWM output	%	0 to 100	75
Triac pulse width		7.g, g32	Triac pulse width for PWM output	ms	0.0 to 10.0	2.5
Mains frequency		7.g, g32	Mains frequency for PWM output	Hz	50, 60	50
Off time with light sensor		7.g, g33	Off time with light sensor	min	0 to 9999	5
Light activation in Off status		7.g, g33	Light activation in OFF status	-	ON/OFF	OFF
Aux activation in Off status		7.g, g33	Auxiliary output activation in OFF status	-	ON/OFF	OFF
Maximum sterilisation duration		7.g, g34	Maximum sterilisation duration	min	0 to 9999	500
Probe heater time		7.g, g35	Maximum probe heater duration	min	0 to 10	2
Probe heater threshold		7.g, g35	End probe heater threshold	° C	0.0 to 90.0	4.0
Enable negative temp. cycles		7.g, g36	Enable negative temperature cycles	-	NO/YES	YES
Dig. in 1 status		7.h, h01	Status of digital input 1	-	Off, On	-
Digital input 1 logic		7.h, h01	Logic of digital input1	-	NO, NC	NC
...		7.h
Dig. in 8 status		7.h, h04	Status of digital input 8	-	Off, On	-
Dig. in 8 logic		7.h, h04	Logic of digital input 8	-	NO, NC	NO
An. input1 value		7.h, h05	Value read by analogue input 1	° C	...	-
An. input1 type		7.h	Type of probe 1	-	--, 4 to 20 mA, 0 to 10 V, NTC, PT1000, ...	NTC

...		7.h
An. input 5 value		7.h, h07	Value read by analogue input 5	°C	...	-
An. input 5 type		7.h, h07	Type of probe 5	-	-, 4 to 20 mA, 0 to 10 V, NTC, PT1000, to	NTC
Device connected to dig. out 1		7.h, h08	Device connected to digital output 1	-	See Chap. 9 CONFIGURATIONS	compressor
Dig. out 1 operation		7.h, h08	Operating mode of digital output 1	-	Auto, Manual	Auto
Dig. out 1 status in manual mode		7.h, h08	Status of digital output 1 in manual operating mode	-	On/ Off	Off
...		7.h
Device connected to dig. out 8		7.h, h15	Device connected to digital output 8	-	See Chap. 9 CONFIGURATIONS	compressor
Dig. out 8 operation		7.h, h15	Operating mode of digital output 8	-	Auto, Manual	Auto
Dig. out 8 status in manual mode		7.h, h15	Status of digital output 8 in manual operating mode	-	On/ Off	Off
Device connected to an. out 1		7.h, h16	Device connected to analogue output 1	-	See Chap. 9 CONFIGURATIONS	Steril.
An. out 1 operation		7.h, h16	Operating mode of analogue output 1	-	Auto, Manual	Auto
An. out 1 status in manual mode		7.h, h16	Status of analogue output 1 in manual operating mode	...	0.0 to 100.0	-
...		7.h
Device connected to an. out 3		7.h, h16	Device connected to analogue output 3	-	See Chap. 9 CONFIGURATIONS	Condenser fan
An. out 3 operation		7.h, h16	Operating mode of analogue output 3	-	Auto, Manual	Auto
An. out 3 status in manual mode		7.h, h16	Status of analogue output 3 in manual operating mode	...	0.0 to 100.0	-
CAREL default		7.i	Reset the CAREL default settings	-	NO/YES	NO
Save config.		7.i	Save the manufacturer configuration	-	NO/YES	NO
New manufacturer password		7.i	New manufacturer password	-	0 to 9999	1234

Clock -  main menu

dd		8.	Day setting	-	1 to 31	-
mm		8.	Month setting	-	1 to 12	-
yy		8.	Year setting	-	0 to 99	-
hh		8.	Hour setting	-	0 to 23	-
mm		8.	Minute setting	-	0 to 59	-

Log -  main menu

HACCP_xxx		9.a	Save HACCP alarm data (for each alarm, the date, time, code, description and help message are saved)	-	to	-
AL_ xxxx		9.b	Save alarm data (for each alarm, the date, time, code, description and help message are saved)	-	to	-
Enable continuous print		9.c	Enable continuous printing of the HACCP alarms and the cycle data	-	NO/YES	NO
Print last HACCP		9.c	Print last HACCP alarm	-	NO/YES	NO
Print last 3 HACCP		9.c	Print last 3 HACCP alarms	-	NO/YES	NO
Print last 10 HACCP		9.c	Print last 10 HACCP alarms	-	NO/YES	NO
Print last cycle		9.c	Print last cycle completed	-	NO/YES	NO
Print last 3 cycles		9.c	Print last 3 cycles completed	-	NO/YES	NO
Print last 10 cycles		9.c	Print last 10 cycles completed	-	NO/YES	NO

Lock keypad -  main menu

Lock keypad		10.	Used to lock the keypad	-	See paragraph 5.10	
-------------	---	-----	-------------------------	---	--------------------	--

 **Note:** all the temperatures can be expressed in degrees °C or °F, depending on the setting of the corresponding parameter (unit of measure – 6.d). The values in the column Range are referred to °C.

7 TABLE OF ALARMS

The table below shows the list of alarms signalled by Blast Chiller. These each have a code (shown in the first column) and a message that is displayed (third column).

Code	Description	Type of reset	Notes
HA	HACCP alarm, high temperature	Manual	Disabled if the door remains open for a preset time
HF	HACCP alarm, blackout during conservation	Manual	
HC	HACCP alarm, blackout during cycle	Manual	
HD	HACCP alarm, cycle ended after maximum time due to probe error	Manual	
HE	HACCP alarm, cycle ended after maximum time	Manual	
E01	Blast chiller/freezer temperature probe 1 not working	Automatic	If only one probe is fitted or both are faulty the duty setting function cannot be activated, if enabled
E02	Blast chiller/freezer temperature probe 2 not working	Automatic	As for alarm ED1
E03	Blast chiller/freezer temperature probe 3 not working	Automatic	As for alarm ED1
E51	Product temperature probe Q not working	Automatic	If only one probe is fitted or both are faulty the cycle cannot end by temperature
E52	Product temperature probe 2 not working	Automatic	As for alarm E51
E53	Product temperature probe 3 not working	Automatic	As for alarm E51
E1	Evaporator temperature probe not working	Automatic	Fans on
E2	Antifreeze temperature probe not working	Automatic	
E6	Condenser temperature probe not working	Automatic	Fans on
Da	External alarm active	Manual	All the devices are off except for the lights and auxiliary outputs, which follow the settings of the related parameters; the pump down cannot be performed. Compressors and fans follow the settings of the related parameters
dor	Door open during conservation	Automatic	The following functions cannot be run: sterilisation, compressors, evaporator fans, cycles, continuous operating mode and defrost
DP	Door open during the cycle	Automatic	The cycle is interrupted
PL	Pause too long during the cycle	Automatic	The cycle is interrupted
LP	Low pressure	Automatic	The compressors and pump down are disabled
HP	High pressure	Manual	Compressors off
OC	Compressor not working	Manual	Compressors off
OF	Fans not working	Manual	Fans and compressors off
OV	Compressor or fans not working	Manual	Fans and compressors off
PP	Product probe not inserted correctly	Automatic	The cycle ends by time
OP	Overload: excess product	Automatic	
cht	High condenser temperature warning: clean the condenser	Automatic	
CHT	High condenser temperature alarm	Manual	Compressors off
PD	Warning: pump down ended after exceeding maximum duration	Automatic	Auto start procedure disabled
Ed	Warning: defrost ended after exceeding maximum duration	Automatic	
MC1	Compressor maintenance required	Manual	
MC2	Compressor 2 maintenance required	Manual	
MEF	Evaporator fan maintenance required	Manual	
MCF	Condenser fan maintenance required	Manual	
MU	Unit maintenance required	Manual	
ML	UV light maintenance required	Automatic	Sterilisation not available
Etc	Clock not working	Manual	Cannot schedule the actions (defrost, lights, auxiliary outputs)
AFr	Antifreeze alarm	Manual	Compressors off
EE	Controller not working	Automatic	Controller not working
HI	High temperature alarm	Automatic	Disabled if the door remains open for a preset time and after defrost
LO	Low temperature alarm	Automatic	Compressors off and disabled during continuous operating mode
Ptr	Printer not working	Manual	Printer disabled

7.1 High and low temperature alarm

Parameters: high temperature alarm threshold, low temperature alarm threshold, temperature alarm differential, type of temperature alarm threshold, high temperature alarm delay, low temperature alarm delay, enable high temperature alarm, enable low temperature alarm.

Description of the function:

the high and low temperature alarm thresholds may be either absolute or relative to the set point, depending on the settings made for the type of temperature alarm threshold. The management of the high and low temperature alarms is displayed in Figure 7.1, with relative thresholds; the operating principle is the same for the absolute thresholds, considering the appropriate values.

The high and low temperature alarms can be disabled by setting the enable/disable high and low temperature alarm parameters.

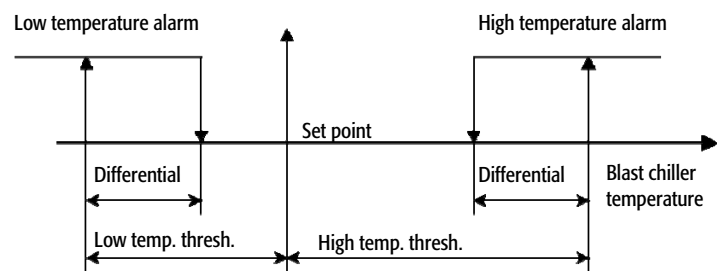

Fig. 7.1 High and low temperature alarm.

8 TABLE OF VARIABLES SENT TO THE SUPERVISOR

Blast Chiller can be connected to various supervisory systems, using the following BMS communication protocols: Carel, Modbus and Lon.

A BMS or FieldBus serial port is used for the connection.

The various connection protocols are managed using the following optional cards:

- **Carel RS485:** code PCOS004850
- **Carel RS232:** code PCO100MDM0, code PCOS00FD20
- **Modbus RS485:** code PCOS004850
- **Lon Works FTT10:** code. PCO1000F0 (*)
- **BACnet RS485:** code. PCO1000BA0 (*)
- **BACnet Ethernet:** code. PCO1000WB0 (*)
- **Trend:** code. PCO100CLP0 (*)



Note: (*) these communication protocols are currently not implemented, however the Blast Chiller software can manage them.

Blast Chiller uses the CAREL PlantVisor PRO software as the supervisor application.

The table below shows the variables sent to the supervisor.

Type	address	R/W	Description
Digital	1	R	Product temperature 1 probe error
Digital	2	R	Product temperature 2 probe error
Digital	3	R	Product temperature 3 probe error
Digital	4	R	Room temperature 1 probe error
Digital	5	R	Room temperature 2 probe error
Digital	6	R	Room temperature 3 probe error
Digital	7	R	Condenser temperature probe error
Digital	8	R	Evaporator temperature probe error
Digital	9	R	Antifreeze temperature probe error
Digital	10	R	Compressor maintenance required
Digital	11	R	Compressor 2 maintenance required
Digital	12	R	Condenser fan maintenance required
Digital	13	R	Evaporator fan maintenance required
Digital	14	R	UV light maintenance required
Digital	15	R	System maintenance required
Digital	16	R	High condenser temperature warning
Digital	17	R	Condenser high temperature alarm
Digital	18	R	Defrost maximum time
Digital	19	R	Door opened during conservation
Digital	20	R	Low pressure alarm
Digital	21	R	Antifreeze alarm
Digital	22	R	Compressor 1 alarm
Digital	23	R	Compressor 2 alarm
Digital	24	R	Black out during conservation phase (HACCP)
Digital	25	R	Black out during cycle execution (HACCP)
Digital	26	R	Controller error
Digital	27	R	High temperature alarm (HACCP)
Digital	28	R	Cycle ended by maximum time for probe error (HACCP)
Digital	29	R	Cycle ended after maximum time (HACCP)
Digital	30	R	High temperature alarm
Digital	31	R	Low temperature alarm
Digital	32	R	Printer error
Digital	33	R	Cycle phase
Digital	34	R/W	Conservation phase
Digital	35	R	On-off digital input
Digital	36	R	External alarm from digital input
Digital	37	R	Door switch
Digital	38	R	Low pressure digital input
Digital	39	R	High pressure digital input
Digital	40	R	Defrost enable digital input
Digital	41	R	Defrost activation digital input
Digital	42	R	Overload
Digital	43	R	Compressor overload
Digital	44	R	Fans overload
Digital	45	R	Light sensor
Digital	46	R	Day/night digital input
Digital	47	R	Auxiliary output activation digital input
Digital	48	R	Compressor
Digital	49	R	Defrost phase
Digital	50	R/W	External alarm
Digital	51	R	Evaporator fans
Digital	52	R	Light
Digital	53	R	Auxiliary output
Digital	54	R	Sterilization
Digital	55	R	Condenser fans
Digital	56	R	Pumpdown valve
Digital	57	R	Compressor 2nd step

Digital	58	R	Probe heater
Digital	60	R	Dripping phase
Digital	61	R	Post dripping
Digital	62	R	Defrost type
Digital	63	R/W	Unit On/Off status
Digital	64	R/W	Buzzer enable
Digital	65	R/W	High temperature alarm enable
Digital	66	R/W	Low temperature alarm enable
Digital	67	R/W	Fan status during defrost
Digital	68	R/W	Compressors control mode
Digital	69	R/W	Enable pumpdown
Digital	70	R/W	Alarms reset
Digital	71	R/W	Buzzer reset
Digital	72	R/W	Manufacturer parameters restore
Digital	73	R/W	On/off by supervisor system
Digital	74	R/W	Manual defrost by supervisor system
Digital	75	R/W	Light on/off by supervisor system
Digital	76	R/W	Auxiliary on/off by supervisor system
Digital	77	R/W	Conservation phase presence after the cycle
Digital	78	R/W	Celsius/Fahrenheit temperature measure unit
Digital	79	R	Pause too long during cycle
Digital	80	R	Door opened during cycle
Digital	81	R/W	Reset alarm history
Digital	82	R	Fan overload alarm
Digital	83	R	Overload alarm
Digital	84	R	High pressure alarm
Analog	1	R	Room temperature probe 1
Analog	2	R	Room temperature probe 2
Analog	3	R	Room temperature probe 3
Analog	4	R	Product temperature probe 1
Analog	5	R	Product temperature probe 2
Analog	6	R	Product temperature probe 3
Analog	7	R	Evaporator temperature probe
Analog	8	R	Condenser temperature probe
Analog	9	R	Antifreeze temperature probe
Analog	10	R	Evaporator fan analog output
Analog	11	R	Condenser fan analog output
Analog	12	R	Sterilization analog output
Analog	13	R	Product setpoint
Analog	14	R	Product temperature
Analog	15	R	Product setpoint during phase 1
Analog	16	R	Product setpoint during phase 2
Analog	17	R	Product setpoint during phase 3
Analog	18	R	Room setpoint
Analog	19	R	Room setpoint during phase 1
Analog	20	R	Room setpoint during phase 2
Analog	21	R	Room setpoint during phase 3
Analog	22	R	Room temperature
Analog	24	R/W	Antifreeze alarm threshold
Analog	25	R/W	Condenser fan differential
Analog	26	R/W	Condenser fan setpoint
Analog	27	R/W	Differential of the condenser high temperature alarm
Analog	28	R/W	Condenser high temperature alarm threshold
Analog	29	R/W	Evaporator fan setpoint
Analog	30	R/W	Evaporator fan differential
Analog	31	R/W	High temperature alarm threshold (HACCP)
Analog	32	R/W	Room temperature alarm differential
Analog	33	R/W	High temperature alarm threshold
Analog	34	R/W	Low temperature alarm threshold
Analog	35	R/W	Room temperature regulation differential
Analog	36	R/W	Room setpoint offset with day/night
Analog	37	R/W	End defrost temperature probe
Analog	38	R/W	Start defrost temperature
Analog	39	R/W	Conservation room temperature setpoint
Integer	1	R	Working hours of the compressor 1 high part
Integer	2	R	Working hours of the compressor 1 low part
Integer	3	R	Working hours of the compressor 2 high part
Integer	4	R	Working hours of the compressor 2 low part
Integer	5	R	Remaining time of the cycle phase
Integer	6	R	Black out time
Integer	7	R	Cycle phase
Integer	8	R	Cycle phase 3 duration
Integer	9	R	Cycle phase 2 duration

Integer	10	R	Cycle phase 1 duration
Integer	11	R	Year
Integer	12	R	Month
Integer	13	R	Day
Integer	14	R	Hour
Integer	15	R	Minute
Integer	16	R/W	Day of the week
Integer	17	R/W	Type of defrost
Integer	18	R/W	Evaporator fan management
Integer	19	R/W	Room high temperature alarm delay
Integer	20	R/W	Room low temperature alarm delay
Integer	23	R/W	Room temperature alarm delay (HACCP)
Integer	24	R/W	Low pressure start delay
Integer	25	R/W	Low pressure delay
Integer	26	R/W	Maximum duration defrost time
Integer	27	R/W	Interval defrost time
Integer	28	R/W	Number of compressors
Integer	29	R	Unit status

Analogue outputs

No.	pCO ³ Small	pCO ⁵
Y1	Evaporator fans/ condenser fans/ sterilisation	Evaporator fans/ condenser fans/ sterilisation
Y2	Evaporator fans/ condenser fans/ sterilisation	Evaporator fans/ condenser fans/ sterilisation
Y3	Evaporator fans/ condenser fans/ sterilisation	Evaporator fans (PWM)/ condenser fans (PWM)
Y 4		---

The following tables, on the other hand, show the standard configurations used by default.

Analogue inputs

No.	pCO ³ Small	pCO ⁵
B1	Product temperature 1	Blastchiller temperature 1
B2	Product temperature 1	Product temperature 1
B3	Evaporator temperature	Evaporator temperature
B4	Condenser temperature	Condenser temperature
B 5	Antifreeze	---

Digital inputs

No.	pCO ³ Small	pCO ⁵
ID 1	On-Off	On-Off
ID 2	External alarm	External alarm
ID 3	Low pressure	Low pressure
ID 4	Door switch	Door switch
ID 5	Activate defrost	Activate defrost
ID 6	Overload	Overload
ID 7	Activate aux output	---
ID 8	High pressure	---

Digital outputs

No.	pCO ³ Small	pCO ⁵
NO1	Compressor	Compressor
NO2	Generic alarm	Generic alarm
NO3	Light	Light
NO4	Aux output	Aux output
NO5	Second-phase compressor	Defrost
NO 6	Pump down	---
NO 7	Probe heater	---
NO 8	Defrost	---

Analogue outputs

No.	pCO ³ Small	pCO ⁵
Y1	Sterilisation	Sterilisation
Y2	Evaporator fans	Evaporator fans
Y3	Condenser fans	Condenser fans (PWM)
Y 4		---

Blank lined page with horizontal ruling lines.

CAREL

CAREL S.p.A.

Via dell'Industria, 11 - 35020 Brugine - Padova (Italy)

Tel. (+39) 049.9716611 Fax (+39) 049.9716600

<http://www.carel.com> - e-mail: carel@carel.com



+030220851 - rel. 1.4 - 23.08.2012