



(ENG) OEM User manual

**LEGGI E CONSERVA
QUESTE ISTRUZIONI**
**READ AND SAVE
THESE INSTRUCTIONS**

**NO POWER
& SIGNAL
CABLES
TOGETHER**
READ CAREFULLY IN THE TEXT!

WARNINGS



CAREL bases the development of its products on decades of experience in HVAC, on the continuous investments in technological innovations to products, procedures and strict quality processes with in-circuit and functional testing on 100% of its products, and on the most innovative production technology available on the market. CAREL and its subsidiaries nonetheless cannot guarantee that all the aspects of the product and the software included with the product respond to the requirements of the final application, despite the product being developed according to start-of-the-art techniques. The customer (manufacturer, developer or installer of the final equipment) accepts all liability and risk relating to the configuration of the product in order to reach the expected results in relation to the specific final installation and/or equipment. CAREL may, based on specific agreements, act as a consultant for the positive commissioning of the final unit/application, however in no case does it accept liability for the correct operation of the final equipment/system.

The CAREL product is a state-of-the-art product, whose operation is specified in the technical documentation supplied with the product or can be downloaded, even prior to purchase, from the website www.carel.com. Each CAREL product, in relation to its advanced level of technology, requires setup/configuration/programming/commissioning to be able to operate in the best possible way for the specific application. The failure to complete such operations, which are required/indicated in the user manual, may cause the final product to malfunction; CAREL accepts no liability in such cases. Only qualified personnel may install or carry out technical service on the product. The customer must only use the product in the manner described in the documentation relating to the product.

In addition to observing any further warnings described in this manual, the following warnings must be heeded for all CAREL products:

- prevent the electronic circuits from getting wet. Rain, humidity and all types of liquids or condensate contain corrosive minerals that may damage the electronic circuits. In any case, the product should be used or stored in environments that comply with the temperature and humidity limits specified in the manual.
- do not install the device in particularly hot environments. Too high temperatures may reduce the life of electronic devices, damage them and deform or melt the plastic parts. In any case, the product should be used or stored in environments that comply with the temperature and humidity limits specified in the manual.
- do not attempt to open the device in any way other than described in the manual.
- do not drop, hit or shake the device, as the internal circuits and mechanisms may be irreparably damaged.
- do not use corrosive chemicals, solvents or aggressive detergents to clean the device.
- do not use the product for applications other than those specified in the technical manual.

All of the above suggestions likewise apply to the controllers, serial boards, programming keys or any other accessory in the CAREL product portfolio. CAREL adopts a policy of continual development. Consequently, CAREL reserves the right to make changes and improvements to any product described in this document without prior warning.

The technical specifications shown in the manual may be changed without prior warning.

The liability of CAREL in relation to its products is specified in the CAREL general contract conditions, available on the website www.carel.com and/or by specific agreements with customers; specifically, to the extent where allowed by applicable legislation, in no case will CAREL, its employees or subsidiaries be liable for any lost earnings or sales, losses of data and information, costs of replacement goods or services, damage to things or people, downtime or any direct, indirect, incidental, actual, punitive, exemplary, special or consequential damage of any kind whatsoever, whether contractual, extra-contractual or due to negligence, or any other liabilities deriving from the installation, use or impossibility to use the product, even if CAREL or its subsidiaries are warned of the possibility of such damage.

IMPORTANT



Separate as much as possible the probe and digital input cables from the cables carrying inductive loads and power cables to avoid possible electromagnetic disturbance.

Never run power cables (including the electrical panel cables) and signal cables in the same conduits.

DISPOSAL



INFORMATION FOR USERS ON THE CORRECT HANDLING OF WASTE ELECTRICAL AND ELECTRONIC EQUIPMENT (WEEE)

In reference to European Union directive 2002/96/EC issued on 27 January 2003 and the related national legislation, please note that:

- WEEE cannot be disposed of as municipal waste and such waste must be collected and disposed of separately;
- the public or private waste collection systems defined by local legislation must be used. In addition, the equipment can be returned to the distributor at the end of its working life when buying new equipment;
- the equipment may contain hazardous substances: the improper use or incorrect disposal of such may have negative effects on human health and on the environment;
- the symbol (crossed-out wheeled bin) shown on the product or on the packaging and on the instruction sheet indicates that the equipment has been introduced onto the market after 13 August 2005 and that it must be disposed of separately;
- in the event of illegal disposal of electrical and electronic waste, the penalties are specified by local waste disposal legislation.

Warranty on materials: 2 years (from the date of production, excluding the consumable parts).

Certification: the quality and safety of CAREL S.p.A. products are guaranteed by the ISO 9001 certified design and production system.

Content

1. INTRODUCTION	7
1.1 General features.....	7
1.2 Components and accessories	7
2. INSTALLATION	8
2.1 pRack Hecu.....	8
2.2 18-24 A three-phase inverter.....	10
2.3 35 A three-phase inverter	11
2.4 E2V unipolar valves	12
2.5 Pressure probes (SKT00**R0).....	12
2.6 Temperature probes	12
2.7 General connection diagram.....	13
2.8 Functional diagrams.....	14
2.9 Installation	15
3. USER INTERFACE	16
3.1 Graphic terminal	16
3.2 Description of the display	16
4. MENU DESCRIPTION	17
4.1 Main menu.....	17
5. COMMISSIONING	18
5.1 Guided commissioning procedure.....	18
6. FUNCTIONS	19
6.1 Unit ON/OFF.....	19
6.2 BLDC compressor.....	19
6.3 Compressor control.....	21
6.4 Backup compressor.....	22
6.5 Fans.....	22
6.6 Oil management.....	23
6.7 High discharge temperature management.....	25
6.8 Liquid injection	25
6.9 Vapour injection.....	25
6.10 Defrost.....	26
6.11 Generic functions.....	27
6.12 Default value management.....	27
7. FAST COMMISSIONING	28
7.1 MPXPRO configuration.....	28
7.2 Connecting MPXPRO to pRack Hecu	30
7.3 MPXPRO control	31
8. SIGNALS AND ALARMS	33
8.1 Alarm management.....	33
8.2 Compressor alarms	33
8.3 Pressure alarms	34
8.4 Anti liquid return MPX valve alarm	34
8.5 Alarm table.....	35
9. SOFTWARE UPDATE	36
9.1 Uploading/updating the software (Upload)	36

1. INTRODUCTION

1.1 General features

Hecu is a control system for complete management of condensing units fitted with BLDC compressors. The serial connection between the condensing unit and the evaporators controlled by MPXPRO represents one of the main features of this solution, contributing to the energy efficiency and reliability of the entire system. The control board is designed for DIN rail assembly and is fitted with plug-in screw terminals, as well as incorporating a driver for managing two electronic expansion valves. Hecu sistema can manage both medium and low temperature applications, managing communication between the main unit and up to five evaporators. A user terminal (PGDe or pLDpro) is also available for service or commissioning the system.

! Important: in order to function, Hecu sistema requires a serial connection to the evaporators fitted with MPXPRO controllers and electronic expansion valves. Without MPXPRO or electronic expansion valves on the evaporators being detected by the pRack Hecu software, the system will not operate.

Main features:

- Management of medium or low temperature applications;
- Modulation of cooling capacity by BLDC compressor with inverter;
- Management of a fixed-speed backup compressor;
- Management of two modulating fans;
- Built-in driver for CAREL single-pole valves;
- Serial communication with evaporators (max 5);
- RS485 serial for BMS;
- Floating suction pressure set point;
- Floating condensing pressure set point;
- Advanced algorithm for the calibrated oil injection to the compressor;
- Advanced algorithm for calibrated liquid or vapour injection to the compressor;
- Oil speed boost for oil return to the compressor;
- Oil recovery washing for oil return to the compressor;
- Vast configuration of defrost functions;
- Suction and discharge superheat control;
- Ample configuration of alarms.

1.2 Components and accessories

P/N	Description
M ECU50SM0C0	pRack Hecu controller, 230 Vac, RTC, 2 single-pole EEVS, connector kit, no BMS, FLSMTDMCUSU
A PGDEH31FX0	PGDE Hecu terminal, for panel installation, with buzzer
A PLDH3GFP00	pLDpro Hecu terminal, for panel installation, with buzzer
A S90CONN000	Connector for pGD evolution display with 1.5 m cable
A S90CONN001	Connector for pGD evolution display with 3 m cable
A PSD1018400	POWER+ 18 A, 380-480V VAC 3PH, IP20/IP44
A PSD1024400	POWER+ 24 A, 380-480V VAC 3PH, IP20/IP44
A PSACH10200	DC choke 1.6Mh for PSD1 18/24A
A PSD1035420	Power+ 35 A, 380-480 VAC 3PH, IP20
O E2V09SSF40	E2V09 smart 12-12 ODF single-pole, 2 m cable, with sight glass
M SPKT00**P0	0-5V pressure transducer sealed gauge 7/16 inch, female
M SPKC00*310	AWG 3-wire cable l=* m for SPKT IP67
M NTC030HT41	HT NTC sensor (INOX CAP 6x50mm) IP55 0T150 3m
M NTC030HF01	HF NTC sensor IP67 -50T90 strap-on l=3 m pack of 10 pcs
M NTC015WH01	WH NTC sensor IP68 -50T105 cable 1,5m
O PCOS004850	Opto-isolated RS485 serial connection card for pCO sistema
O PCOS005030	Fastening bracket for RS485/LON/RS232 serial card

For the evaporators:

M MX30M25H00	MPXPRO ms+EEV step + 0-10 Vdc + ultracap, 8-16-8-8-2PWM, NTC/PT1000 cover, vert. term. switching
M IR00UGC300	Terminal (MPXPRO, green LED, keypad, buzzer, commissioning, IR)
M NTC060HP00	HP NTC sensor IP67 -50T50 (-50t100 in air) 6 m
M NTC060HF01	HF NTC sensor IP67 -50T90 strap-on l=6 m pack of 10 pcs
M SPKT00**P0	0-5V pressure transducer sealed gauge 7/16 inch, female
M SPKC00*310	AWG 3-wire cable l=* m for SPKT IP67
M E2V**SSF10	E2V** smart 12-12 ODF without sight glass
M E2VCABS600	E2V connector L=6m

Tab. 1.a

Key:

M	mandatory	A	mandatory / alternative	O	optional
---	-----------	---	-------------------------	---	----------

HECU system example

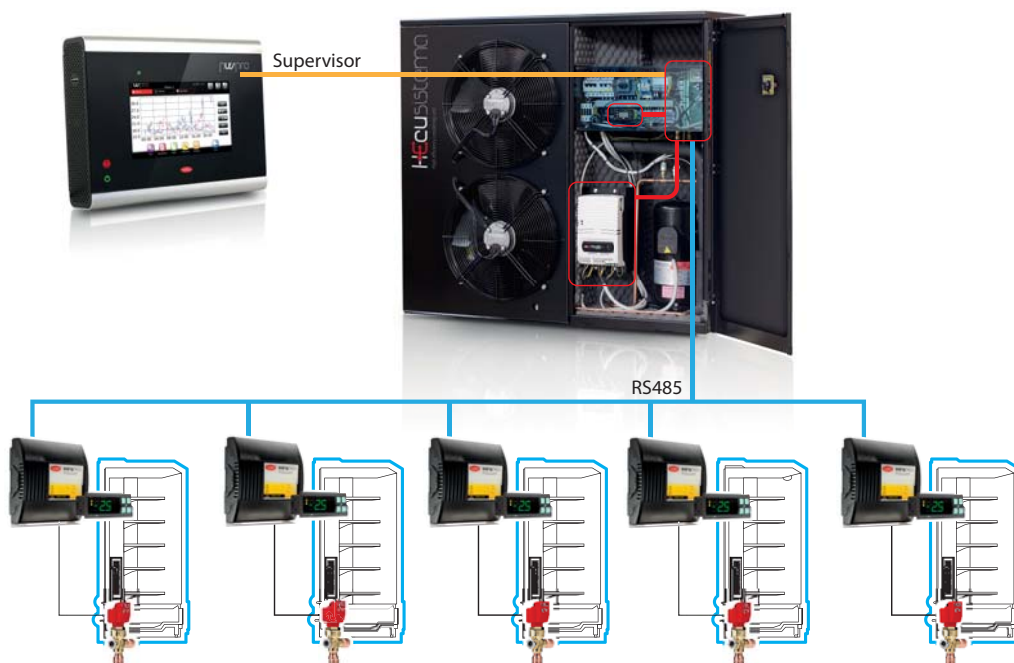

Fig. 1.a

2. INSTALLATION

2.1 pRack Hecu

Main board: description of the terminals

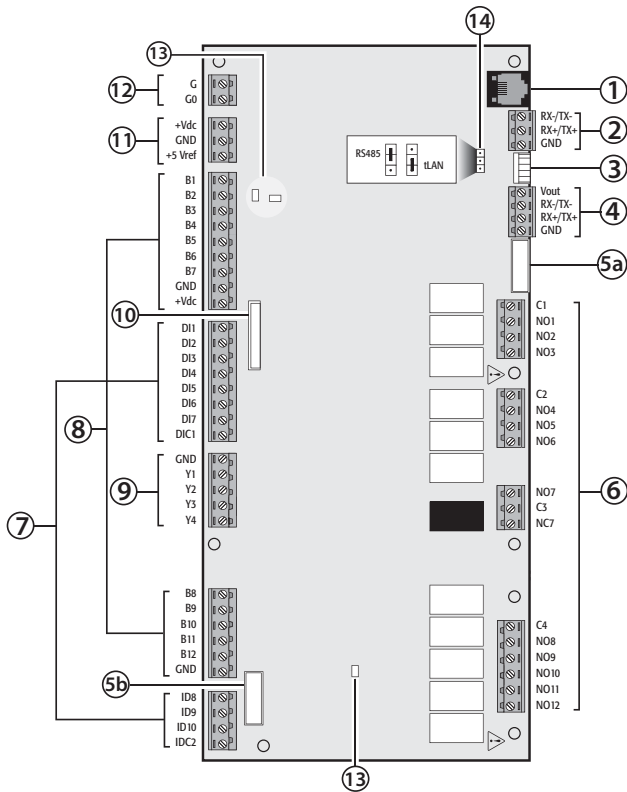

Fig. 2.a

Key:

- 1 Terminal/application download connector (note 1)
- 2 Hecu bus
- 3 pLD terminal connector (note 2)
- 4 RS485/tLAN connection (note 2)
- 5a Valve 1 control output
- 5b Valve 2 control output
- 6 Relay digital output
- 7 Digital Input
- 8 Probe analogue input
- 9 Analogue output
- 10 Serial card
- 11 Power supply for external probe
- 12 Power supply: 230 Vac
- 13 LED:
 - Orange: power
 - Green: BIOS (ON = BIOS active correctly, OFF = BIOS not active)
- 14 tLAN/RS485 jumper



Note: the application program can be downloaded to the flash memory from a PC using the USB-485 adapter "CVSTDUTLFO" and a special program, to be requested from CAREL.

Valve connector

The valve connector pins are connected as follows:

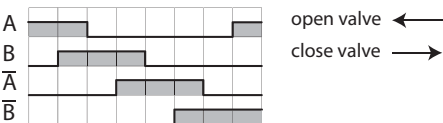
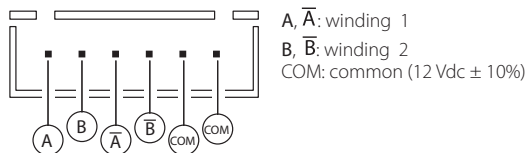

Medium model dimensions (mm)

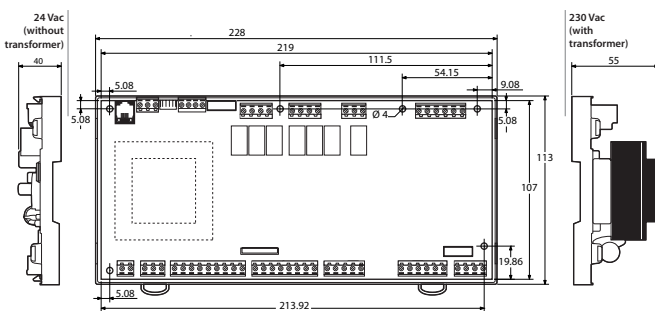

Fig. 2.b

Physical specifications

dimensions	Medium version installable on 13 DIN modules, 228 x 113 x 55 mm
assembly	DIN rail

Plastic case

- fitted on DIN rail in accordance with DIN 43880 and EN 50022;
- material: technopolymer;
- flammability: V0 (UL94) and 850 °C (IEC 695);
- ball pressure test: 125 °C;
- resistance to creeping current: ≥250 V;
- colour: grey RAL7035;

Electrical specifications

power supply	230 Vac, +10...-15%, 50-60 Hz
(controller with terminal connected)	maximum power consumption: 25 VA
insulation between mains and controller	double
terminal block	with M/F plug-in connectors, max voltage 250 Vac; cable cross-section: min. 0.5 mm ² - max 2.5 mm ² Max tightening torque 0.4 Nm
parameter data memory	13 kB in 8-bit (max. limit: 400,000 writes per memory location)
battery specifications	CR2430 lithium button battery, 3 Vdc (24x3 mm); operating temperature characteristics shown in paragraph 2.10.
battery life	Minimum 8 years in normal operating conditions

Tab. 2.b

Digital inputs

Type	voltage-free contact
Number	10

Note: separate as much as possible the probe and digital input cables from cables to inductive loads and power cables, so as to avoid possible electromagnetic disturbance. The first of the two inputs can be used as a fast digital input.

Analogue outputs

output type	Y1, Y2: 0 to 10 Vdc Y3, Y4: 0 to 10 Vdc / PWM 0/5 Vdc for MCHRTF* controllers
max. number	4
resolution	8-bit
maximum load	2 kΩ (5 mA) for 0 to 10Vdc outputs 1 kΩ (5 mA) for 0-5 V PWM outputs
precision	±3 % of full scale; ±5 % of full scale (max load 5 mA)

Tab. 2.c

Analogue inputs

analogue conversion	10-bit A/D converter integrated in CPU	
maximum number	12	
type	B1, B2, B3, B4, B8, B9	low NTC temperature: 10 kΩ ± 0.1% at 25°C, -50T90 °C high NTC temperature: 50 kΩ at 25°C, 0T150 °C 0 to 1 V input
	B5, B10	low NTC temperature: 10 kΩ at 25°C, -50T90 °C high NTC temperature: 50 kΩ at 25°C, 0T150 °C 0 to 1 V input 4 to 20 mA input
	B6, B7, B11, B12	low NTC temperature: 10 kΩ at 25°C, -50T90 °C high NTC temperature: 50 kΩ at 25°C, 0T150 °C 0 to 1 V input ratiometric pressure sensor (0 to 5 V)
time constant for each input	0.5 s	
input precision	±0.3% of full scale	
classification of measuring circuits (EN 61010-1)	Category I	

Tab. 2.d

Note: the Vdc available at the +Vdc terminal can be used to power any active probes. The voltage depends on the model: +26Vdc +-15% for ECUS0SM0C0 (230 Vac). The maximum current is 150 mA, thermally protected against short-circuits. To power the 0 to 5 V ratiometric probes, use the +SVREF (Imax: 60 mA).

Digital outputs

Insulation distance	Note: the relays in the same group with basic insulation must have the same power supply.			
	Makeup of groups			
	Version	Group 1	Group 2	Group 3
	MEDIUM	1 to 6	7	8 to 12
	Note: the relays in the game group have basic insulation between them; relays between groups (group1, group2, group3) have double insulation			
Medium relay from 1 to 12	EN60730-1: NO 1(1)A 250 Vac cos phi = 0.4; 100,000 cycles UL-873: NA 1 A resistive 24 Vac, 30 Vdc, 100,000 cycles/ PILOT DUTY: 24 Vac, peak 15 A, continuous 1A 30,000 cycles			

Tab. 2.e

User terminal connection

The maximum distance between Hecu and the user terminal is shown below:

cable type	power supply distance	power supply
telephone	10 m	taken from Hecu (150 mA)
AWG24 shielded cable	200 m	taken from Hecu (150 mA)

Tab. 2.f

Note:

- a maximum of one terminal can be connected;
- the graphic terminal and other terminals must always be powered with a separate power supply;
- the protocol used (RS485 / tLAN) is selected using a 3-pin jumper. Both protocols (RS485/tLAN) are not available at the same time.

Valve control

max power consumption for each valve	7 W
valve type	single-pole stepper motor
valve connector pins	6
power supply	12 Vdc ±10%
maximum current	0.3 A for each winding
minimum winding resistance	40 Ω
maximum length of the cable	2 m without shielded cable 6 m using shielded cable earthed at both ends (E2VCABS3U0, E2VCABS6U0)

Tab. 2.g

Note:

- ECUS0SM0C0 models can manage two separate valves. The two valves are not controlled at the same time, but in sequence;
- only one valve can be connected to each connector;
- the step frequency is selected by software;
- select the correct valve to guarantee best performance

Other specifications

storage conditions	-20T70 °C, 90% RH non-condensing
operating conditions	-10T60 °C, 90% RH non-condensing
ingress protection	IP00
environmental pollution	normal
class according to protection against electric shock	to be integrated into class I and/or II appliances
PTI of insulating materials	250 V
period of stress across the insulating parts	long
type of action	1 C
type of disconnection or microswitching	microswitching
cat. of heat and fire resistance	category D (UL94 - V0)
overvoltage category	category I
ageing characteristics (operating hours)	80,000
no. of automatic operating cycles	100,000 (EN 60730-1); 30,000 (UL 873)
software class and structure	Class A
overvoltage category (EN 61000-4-5)	Category III
The device is not designed to be hand-held	

Tab. 2.h

Important:

- For applications subject to strong vibrations (1.5 mm pk-pk 10/55 Hz), secure the cables connected to the Hecu using clamps placed around 3 cm from the connectors. It is strongly recommended not to remove the plastic cover;
- the entire length of the input/output connections must be less than 10 m, in accordance with EN 61000-6-2;
- installation must be performed in compliance with the standards and legislation in force in the country where the appliance is used;
- for safety reasons the appliance must be used inside an electrical panel, with minimum IP20 protection, so that the only accessible part is the display and the control keypad;
- all extra low voltage connections (24 Vac/Vdc analogue and digital inputs, analogue outputs, serial bus connections, power) must have reinforced (or double) insulation from the mains;
- in the event of malfunctions do not attempt to repair the appliance, but rather contact the CAREL service centre.

2.2 18-24 A three-phase inverter

Go to www.carel.com to check for any new versions of the technical documents. The following documents are taken from instruction sheet +0500048IE rel. 2.2 of 07/11/2014.

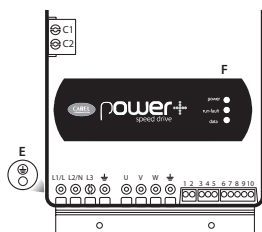

Fig. 2.c

Description of the terminals

Ref.	Description	
L1/L, L2/N, L3 ⊥ earth (*)	Three-phase power supply input	
L1/L, L2/N ⊥ earth (*)	Single-phase power supply input	
U, V, W ⊥ earth (*)	Motor output	
C1, C2	Optional DC choke terminals on PSD10184** and PSD10244**	
1,2	Relay output	
3	0 V	
4	Tx/Rx+	RS485/ModBus® connection
5	Tx/Rx-	
6	PTC input	
7	24 Vdc	Auxiliary voltage
8	0V	
9	STOa	Safe Torque Off input (**)
10	STOb	
E	PE ⊕	
F (LED)	POWER (green)	drive powered
	RUN/FAULT (green/red)	drive running / drive alarm
	DATA (yellow)	communication active

(*) The earth connections inside the drive are electrically connected together and to PE.

(**) To enable the drive for operation, apply 24 Vac/Vdc to the Safe Torque Off input. The polarity is indifferent for DC power supply.

Main technical specifications

Ref. technical document	+0500048IE rel. 2.2 of 07/11/2014
Operating temp.	-20T60°C
Humidity	<95% RH non-condensing
Pollution degree	Max 2
Input voltage	200 - 240V ± 10%, 50 - 60 Hz, 1~
Output voltage	0 - Input voltage
Output frequency	0 - 500 Hz
Maximum length	5 m
Switching frequency	4, 6, 8 kHz
Protection functions	Drive: short-circuit, overcurrent, ground fault, over-voltage and under-voltage, over-temperature Motor: over-temperature and overload (150% Inom for 1 minute) System: Safe Torque OFF input, no communication
Frequency resolution	0.1 Hz
Inputs	1 motor protector input: PTC temp. probe or voltage-free contact max source current 10 mA, max. length 25 m
Outputs	1 relay: progr. output, voltage-free cont: 240Vac, 1A
Serial input	RS485, Modbus® protocol, max speed 19200 bit/s
24 Vdc auxiliary power	Double insulation, precision 10%, 50 mA max
Maximum length	100 m shielded cable
Ingress protection	IP20

CE conformity:

- 2006/95/EC EN 61800-5-1: Adjustable speed electrical power drive systems. Safety requirements. Electrical, thermal and energy.
- 2004/108/EC EN 61800-3, ed.2.0: Adjustable speed electrical power drive systems. EMC requirements and specific test methods.
EN61000-3-2: Electromagnetic compatibility (EMC) Part 3-2: Limits for harmonic currents (equipment connected with input current > 16 A per phase).
EN61000-3-12: Electromagnetic compatibility (EMC) Part 3-12: Limits - Limits for harmonic currents (equipment connected with input current > 16 A and ≤ 75 A per phase).

Rated values

The table below shows the rated input and output values, as well as the specifications for sizing the cables (cross-section, maximum length) and the fuses. The values refer to an operating temperature of 60 °C and a switching frequency of 8 kHz, unless otherwise specified.

Model	PSD1018400	PSD1024400
Rated input current at 400V	23A	30 A
Fuse or type B circuit breaker	32A	40 A
Power cable cross-section	4 mm ²	6 mm ²
Rated output current	18 A	24A
Rated output power at 400V	10.5 kW	14 kW
Max. total dissipation	320 W	485 W
Max. heat sink dissipation	250 W	380 W
Minimum motor cable cross-section	4 mm ²	4 mm ²
Maximum motor cable length	5 m	5 m

Tab. 2.i

DC choke

The DC choke is an option supplied separately to be used with the three-phase Power+ drive for reducing harmonic current distortion to the levels specified by EN61000-3-12.

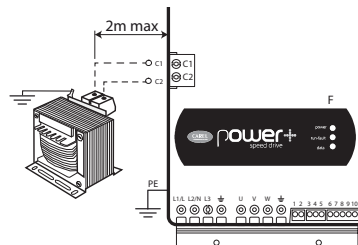

Fig. 2.d

- connect the DC choke to terminals C1 and C2;
- earth the DC choke using the metal terminal provided;
- to connect the DC choke, use a cable with the same cross-section as the power cable;
- maximum cable length is 2 m.

DC choke P/N	to be installed on Power+ drive	Type
PSACH10200	PSD1024400, PSD10244A0, PSD1018400, PSD10184A0	1.6 mH, 45 A peak

Cooling

All Power+ drives feature forced ventilation for cooling the heat sink. Sufficient air flow and air change must be provided inside the electrical panel. All Power+ drives have the fan located on the right-hand side. Avoid hot air intake to the fan.

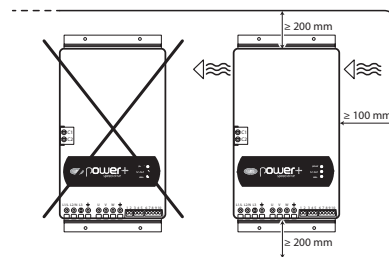

Fig. 2.e

Dimensions

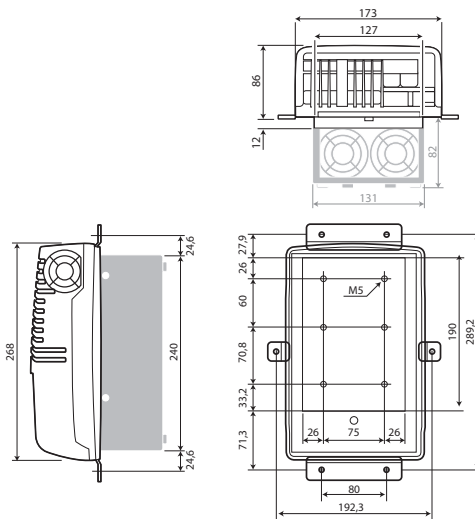

Fig. 2.f

2.3 35 A three-phase inverter

Go to www.carel.com to check for any new versions of the technical documents. The following documents are taken from instruction sheet +0500048IE rel. 2.2 of 07/11/2014.

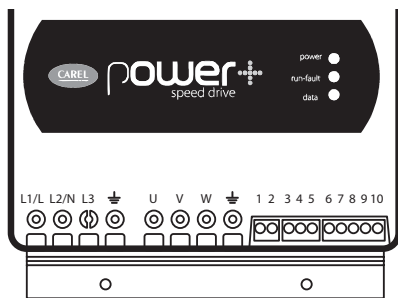

Fig. 2.g

Description of the terminals

Ref.	Description
L1, L2, L3	Three-phase power supply input
⊕ Earth	
U, V, W	Motor output
⊕ Earth	
1, 2	Relay output
3	GND
4	Tx/Rx+
5	Tx/Rx-
6	PTC
7	24 Vdc
8	0V
9	STOa
10	STOb
F (LED)	POWER (green)
	RUN/FAULT (green/red)
	DATA (yellow)

(*) To enable the drive for operation, apply 24 Vac/Vdc to the Safe Torque Off input. The polarity is indifferent for DC power supply.

Main technical specifications

Ref. technical document	+0500072IE rel. 1.2 of 07/10/2014
Operating temp.	-20T60°C
Humidity	<95% RH non-condensing
Pollution degree	Max 2
Input voltage	380 - 480 Vac ± 10%, 50/60 Hz, 3~ (model PSD10**4*0)
Output voltage	0 - Input voltage
Output frequency	0 - 500 Hz
Maximum length	5 m
Switching frequency	4, 6, 8 kHz
Protection functions	Drive: short-circuit, overcurrent, ground fault, over-voltage and under-voltage, over-temperature Motor: over-temperature and overload (150% Inom for 1 minute) System: Safe Torque OFF input, loss of communication
Frequency resolution	0.1 Hz
Inputs	1 motor protector input: PTC temp. probe or voltage-free contact max source current 10 mA, max. length 25 m. 1 "Safe Torque Off" input 1 contact @ 24 Vdc ± 20%, 24 Vac +10%/-20%: typical input current 10 mA, maximum length 25m
Outputs	1 relay: prog. output, voltage-free cont: 240 Vac, 1 A
Serial input	RS485, Modbus® protocol, max speed 19200 bit/s
24 Vdc auxiliary power	Double insulation, precision 10%, 50 mA max
Maximum length	100 m shielded cable
Ingress protection	IP20

CE conformity:

2006/95/EC EN 61800-5-1: Adjustable speed electrical power drive systems. Safety requirements. Electrical, thermal and energy.
2004/108/EC EN 61800-3, ed.2.0: Adjustable speed electrical power drive systems. EMC requirements and specific test methods.
 EN61000-3-2: Electromagnetic compatibility (EMC) Part 3-2: Limits for harmonic currents (equipment connected with input current > 16 A per phase).
 EN61000-3-12: Electromagnetic compatibility (EMC) Part 3-12: Limits - Limits for harmonic currents (equipment connected with input current > 16 A and <= 75 A per phase).

Rated values

The table below shows the rated input and output values, as well as the specifications for sizing the cables (cross-section, maximum length) and the fuses. The values refer to an operating temperature of 60 °C and a switching frequency of 8 kHz, unless otherwise specified.

Model	PSD1035420
Rated input current at 400V	35A
Fuse or type B circuit breaker	40A
Power cable cross-section	6 mm ²
Rated output current	35 A
Rated output power at 400V	21 kW
Max. total dissipation	600 W
Max. heat sink dissipation	500 W
Minimum motor cable cross-section	6 mm ²
Maximum motor cable length	5 m

Tab. 2.j

Cooling

All Power+ drives, excluding the Coldplate models, feature forced ventilation for cooling the heat sink. Sufficient air flow and air change must be provided inside the electrical panel. See the table in paragraph 9.1 for the maximum heat dissipation values. All Power+ drives have the fan located on the right-hand side. Avoid hot air intake to the fan.

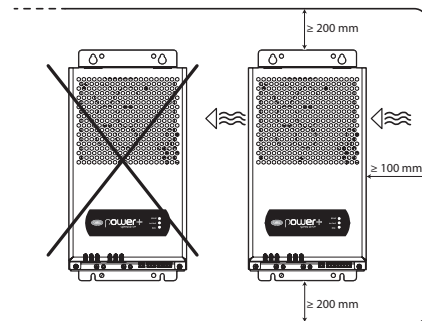

Fig. 2.h

Dimensions

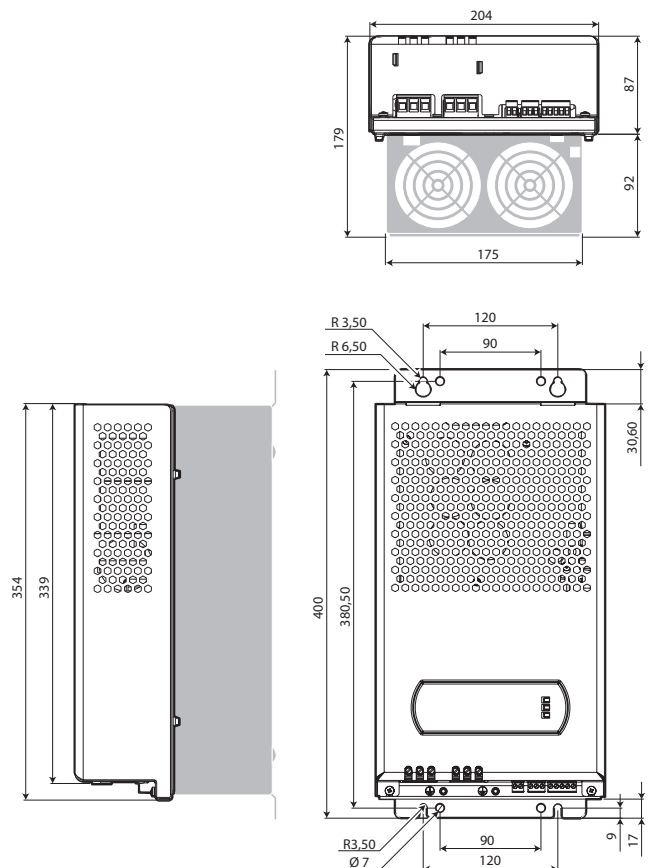
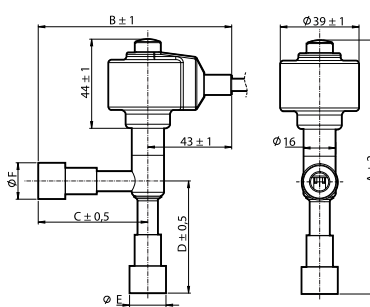
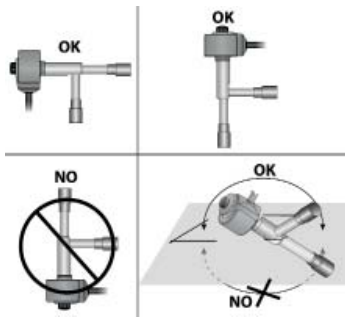

Fig. 2.i

2.4 E2V unipolar valves



Valve type	E2V**USF** copper 12-12
A	123.7 mm (4.87 inch)
B	95.3 mm (3.28 inch)
C	52.2 mm (2.06 inch)
D	53.5 mm (2.11 inch)
E	OD 14/ID 12 mm (out 0.55/in 0.47 inch)
F	OD 14/ID 12 mm (out 0.55/in 0.47 inch)

CAREL E2V-U operating specifications

Reference technical document	+050001440 rel. 4.1 09/01/2015
Compatibility	R22, R134a, R404A, R407C, R410A, R744, R507A, R417A
Maximum operating pressure (MOP)	up to 45 bars (653 psi)
Maximum operating PD (MOPD)	35 bars (508 psi)
PED	Gr. 2, art. 3, par. 3
Refrigerant temperature	-40T65 °C (-40T149 °F)
Room temperature	-30T50 °C (-22T122 °F)

CAREL E2V-U stator

Reference technical document	+050001440 rel. 4.1 09/01/2015
Power supply voltage	12 V
Control frequency	50 Hz
Phase resistance (25 °C)	40 Ohm ± 10%
Ingress protection	IP67
Connections	6 pin, cable length: 2 m
Complete closing / control steps	500 / 480

2.5 Pressure probes (SKT00**P0)

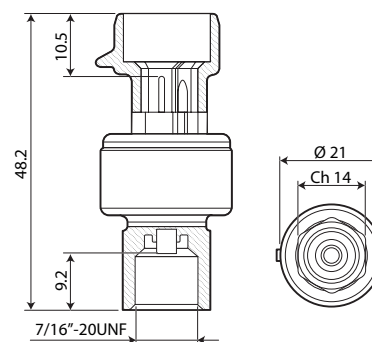
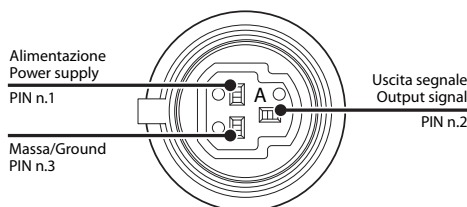

Reference technical document	+050000598 rel. 1.0 - 25.03.2015
Power supply	4,5...5,5 Vdc
Output	0,5...4,5 Vdc
Connector thread	7/16 20 UNF - 1/4" SAE
Operating temperature	-40T135 °C
Storage temperature	-40T150 °C
Fluid temperature	-40T135 °C
Ingress protection	IP65 with mechanical protection; IP67 with electrical connector plugged in
Environmental pollution	Grade 3
Material in contact with the fluid	Brass
Separation with plastic membrane	compatible with fluids R12, R22, R134A, R404A, R407C, R410A, R502, R507, R744, HFO 1234ze not compatible with R717 (ammonia), not to be used with water and glycol
Tightening force	12 to 16 Nm

2.6 Temperature probes

Model	NTC***WH01	NTC***HT41	NTC***HF01
Reference technical document	+030220655 rel. 2.2 of 18/03/2015	+030220655 rel. 2.2 of 18/03/2015	+030220655 rel. 2.2 of 18/03/2015
Operating range	-50T105 °C in air	0T150 °C in air	-50T105 °C
Connections	Stripped terminals, dimensions: 5±1 mm	Stripped terminals, dimensions: 6±1 mm	Stripped terminals, dimensions: 6±1 mm
Sensor	NTC 10 kΩ ±1% a 25 °C Beta 3435	NTC 50 kΩ ±1% at 25°C Beta 3977	R(25 °C)= 10 kOhm 1%; Beta 3435
Dissipation factor (in air)	ca. / approx. 2,2 mW/°C	approx. 3 mW	3 mW
Thermal time constant (in air)	ca. / approx. 30 s	approx. 30 s	approx. 50 s
Sensor element ingress protection	IP68	IP55	IP67
Sensor housing	PP/Co with AISI 316 outer cap	High temperature polyester dim. 20x5 mm	Thermoplastic with fastening clamp
Classification according to protection against electric shock	Supplementary insulation for 250 Vac;	Basic insulation for 250 Vac	Basic insulation for 250 Vac
Heat and fire resistance category	Flame retardant	In accordance with CEI 20-35	UL/HB cable



for external temperature

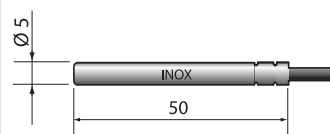

for discharge temperature

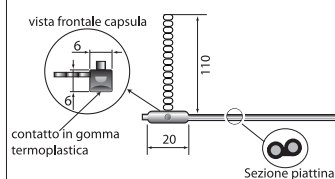

- for temperature evaporation
- liquid temperature
- vapour injection temperature

2.7 General connection diagram



PAY ATTENTION TO THE POWER SUPPLY!

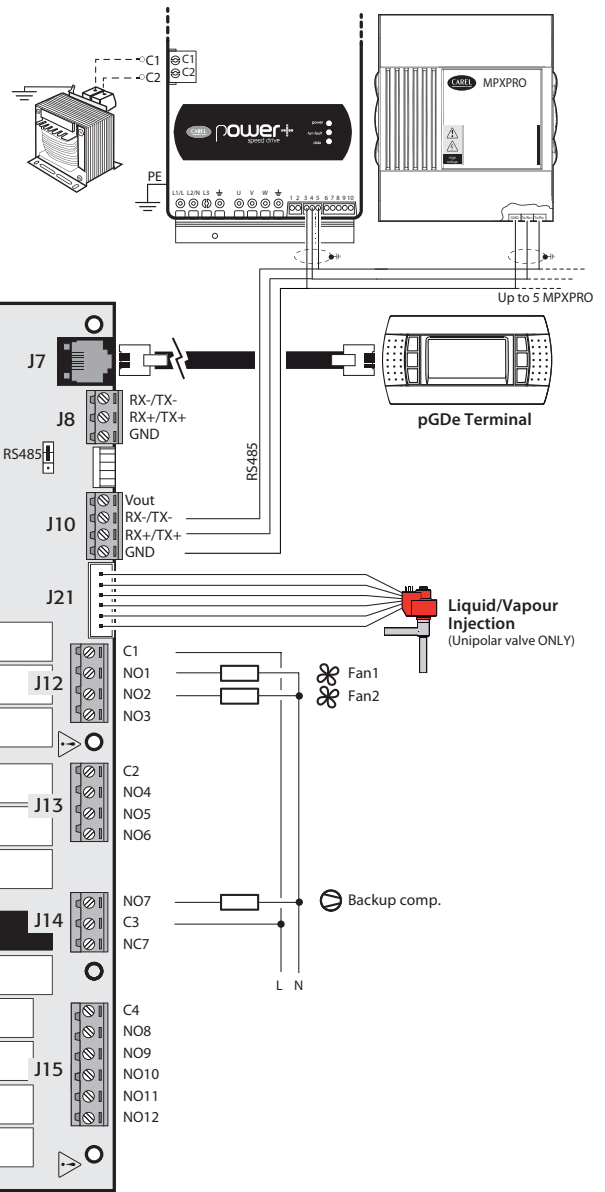

Fig. 2.j

(*) The 4-20 mA pressure probes are connected by attaching white to Ux and black to +Vdc, green is not used

Important: class A software - the safety devices providing overload and high pressure protection must control the compressor directly, and consequently need to be wired in series with compressor contactor control signal.

I/O selection tables

Analogue inputs	Description
B1	Vapour injection temperature (default)
B2	Liquid temperature
B3	Suction temperature (default)
B4	BLDC comp discharge temperature (default)
B6	Suction pressure (default)
B7	Condensing pressure (default)
B8	Backup comp discharge temperature (default)
B9	Outside temperature
B11	Vapour injection pressure (default)

Digital inputs	Description
ID1	High pressure alarm
ID2	Low pressure alarm
ID3	BLDC comp. alarm
ID4	Backup comp. alarm
ID5	Fan alarm
ID6	Remote ON-OFF
ID8	Minimum oil level in separator (red)
ID9	Maximum oil level in separator (yellow)

Analogue outputs	Description
Y1	Modulating fans (default)

Digital outputs	Description
DO1	Fan 1 (default)
DO2	Fan 2 (default)
DO7	Backup compressor

Tab. 2.k

Note: "default" refers to the I/Os auto-configured at the end of the wizard procedure. Any configurations other the default can be made on the user terminal.

2.8 Functional diagrams

There are two possible configurations, one for medium temperature applications and one for low temperature applications. The main difference involves liquid injection in the suction line, which in low temperature applications becomes vapour injection directly into the compressor.

1. Medium temperature configuration

This configuration involves pRack Hecu managing a BLDC compressor, a maximum of two modulating fans, an electronic expansion valve for oil injection, and an electronic expansion valve for liquid injection. The serial network allows monitoring and interaction with a maximum of five evaporators fitted with MPXPRO controllers.

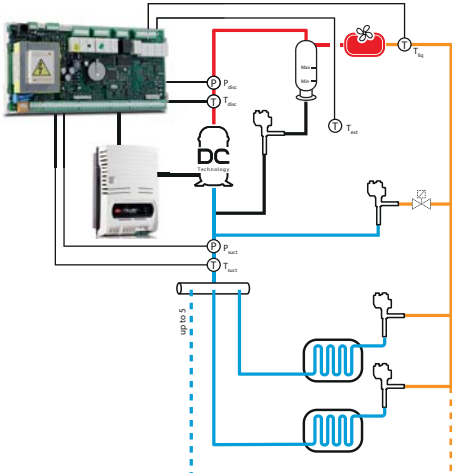

Fig. 2.k

Symbol	Description
T_{suct}	Suction Temperature
P_{suct}	Suction Pressure
T_{disc}	Discharge Temperature
P_{disc}	Discharge Pressure
T_{liq}	Liquid Temperature
T_{ext}	External Temperature

Tab. 2.l

Note: select the probes limit according to the operative conditions and the ambient temperature of the installation.

2. Low temperature configuration

This configuration involves pRack Hecu managing a BLDC compressor, a maximum of two modulating fans, an electronic expansion valve for oil injection, and an electronic expansion valve for liquid injection. The serial network allows monitoring and interaction with a maximum of five evaporators fitted with MPXPRO controllers.

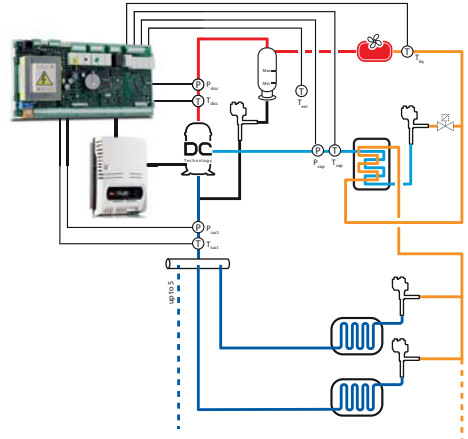

Fig. 2.l

Symbol	Description
T_{suct}	Suction Temperature
P_{suct}	Suction Pressure
T_{disc}	Discharge Temperature
P_{disc}	Discharge Pressure
T_{liq}	Liquid Temperature
T_{ext}	External Temperature
T_{vap}	Vapor Injection Temp.
P_{vap}	Vapor Injection Pressure

Tab. 2.m

Note: select the probes limit according to the operative conditions and the ambient temperature of the installation.

3. Serial network configuration

pRack Hecu is fitted with a built-in RS485 Fieldbus serial port and optional RS485 BMS serial port. The RS485 Fieldbus serial line can be connected to 1 power+ inverter and up to 5 MPXPRO controllers.

The addresses are defined as shown in the following table. To simplify commissioning with the default settings, it is recommended to set the MPXPRO controllers with consecutive addresses, starting from address 2.

Device	Address	Device	Address
Power+	1	MPXPRO 3	13
MPXPRO 1	11	MPXPRO 4	14
MPXPRO 2	12	MPXPRO 5	15

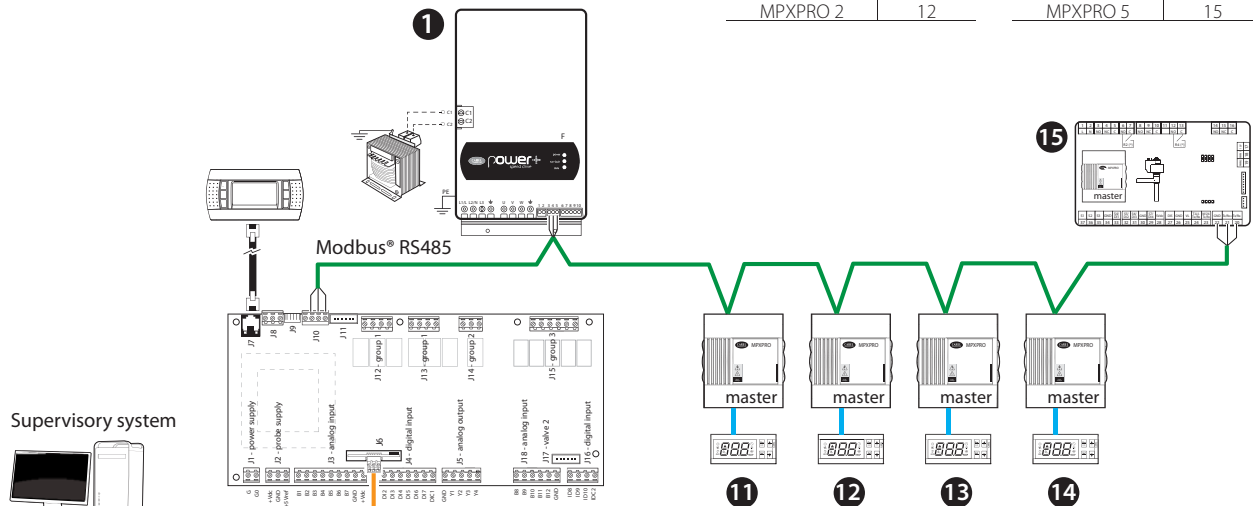

Fig. 2.m

2.9 Installation

For installation, proceed as follows, with reference to the wiring diagrams:

- before performing any operations on the control board, disconnect the main power supply by turning the main switch in the electrical panel OFF.
- avoid touching the control board with bare hands, as any electrostatic discharges may damage the electronic components;
- suitable electrical protection must be ensured by the manufacturer of the cabinet or by appropriate installation of the controller;
- if there are several condensing units connected to the same electrical panel, use a B or B+ residual current circuit breaker when the compressors are controlled by inverter; these protection devices must always be installed always upstream of the AC/A/F (see the figure below):

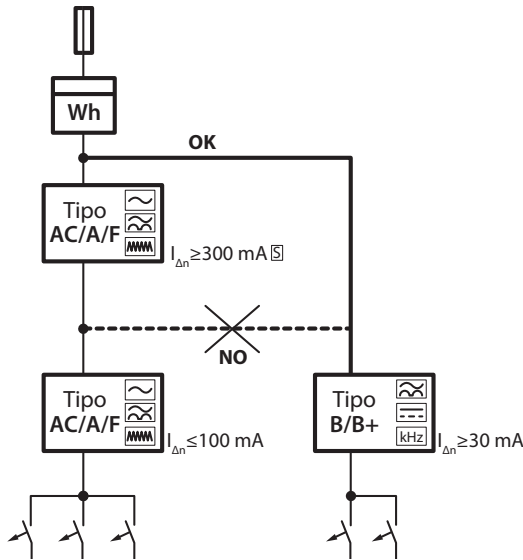

Fig. 2.n

- connect any digital inputs, $L_{max}=10\text{ m}$;
- connect the temperature and pressure probe, $L_{max}=10\text{ m}$;
- connect the electronic expansion valve cables to connectors J17 and J21;
- connect the inverter serial communication cable (if used) to terminal J10;
- connect the optional PGDe terminal (needed for commissioning) to connector J17;
- connect power supply to controller and the inverter, if used;
- program the controller using the guided commissioning procedure: see the chapter on Commissioning”.
- connect the electrical loads to the relay outputs only after having programmed the controller. Always carefully evaluate the maximum capacity of the output relays, as specified in the Technical specifications;
- connect the supervisor serial line to the optional RS485 BMS card.

- ! Important:** avoid installing the controllers in environments with the following characteristics:
- relative humidity greater than 90% or with condensation;
 - strong vibrations or knocks;
 - exposure to water sprays;
 - exposure to aggressive and polluting atmospheres (e.g.: sulphur and ammonia fumes, saline mist, smoke) to avoid corrosion and/or oxidation;
 - strong magnetic and/or radio frequency interference (therefore avoid installing the devices near transmitting antennae);
 - exposure of the controllers to direct sunlight and to the elements in general.

! Important: the following warnings must be observed when connecting the controllers:

- incorrect power connections may seriously damage the controller;
- use cable ends suitable for the corresponding terminals. Loosen each screw and insert the cable ends, then tighten the screws and gently tug the cables to check they are sufficiently tight;
- separate as much as possible the probe and digital input cables from cables to inductive loads and power cables, so as to avoid possible electromagnetic disturbance. Never run power cables (including the electrical panel cables) and probe signal cables in the same conduits;
- do not run probe signal cables in the immediate vicinity of power devices (contactors, circuit breakers, etc.);
- reduce the path of probe cables as much as possible, and avoid spiral paths that enclose power devices.

! Important: class A software - the safety devices providing overload and high pressure protection must control the compressor directly, and consequently need to be wired in series with compressor contactor control signal.

Note: The serial connection starts from terminal J10 on pRack Hecu and runs through the power+ inverter and all the MPXPRO controllers installed on the refrigerated units. The maximum number of MPXPRO controllers is 5, the limit for this application. The following recommendations must be heeded:

- connect the two twisted wires to the Tx/Rx+ and Tx/Rx- terminals;
- connect the single wire to the GND terminal;
- connect the shield to earth at one end only;
- use a shielded cable (e.g. Belden 3106A – AWG 22);
- For supervisor serial network connection only: connect a 120 Ω terminating resistor between the Tx/Rx+ and Tx/Rx- terminals on the last controller in the network (the one furthest away from pRack Hecu).

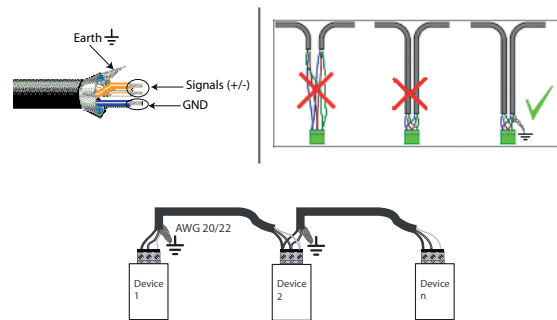

3. USER INTERFACE

3.1 Graphic terminal

pRack Hecu user interface is the pGDE terminal, in the panel or built-in version. The functions associated with the 6 buttons on the pGDE terminal are the same on all masks, and are described in the table.

Functions of the 6 buttons

Button	Associated function
	(ALARM) Displays the list of active alarms and accesses the alarm log
	Used to enter the main menu tree
	Returns to the higher level mask
	(UP) Scroll a list upwards or increases the value highlighted by the cursor
	(DOWN) Scroll a list downwards or decreases the value highlighted by the cursor
	(ENTER) Enters the selected submenu or confirms the set value

Tab. 3.a

The LEDs associated with the buttons have the following meaning.

Meaning of the LEDs

LED	Button	Meaning
Red		Flashing: active alarms and not acknowledged Steady: alarms acknowledged
Yellow		pRack Hecu on
Green		pRack Hecu powered

Tab. 3.b

3.2 Description of the display

There are three fundamental types of masks shown to the user:

- Main mask
- Menu mask
- Screen for displaying/setting the parameters

Main mask

The software on board pRack Hecu automatically returns to the main mask 5 minutes after the last button was pressed. An example of the main mask is shown in the figure, highlighting the fields and icons used.

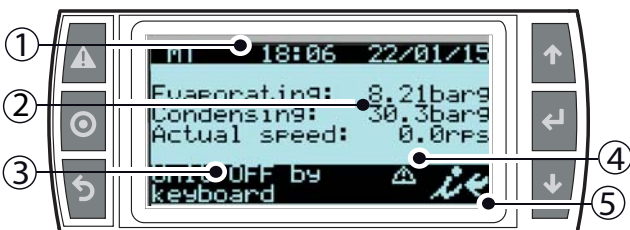

Fig. 3.a

1	Time and date
2	Main values.
3	Unit status (unit off) or compressor and fan status (unit on)
4	Active alarm signal and manual operation
5	Access further information masks (menu branch A.a) by pressing ENTER

Note:

- The information shown on the main mask varies according to the system configuration and the type of control value used (pressure, temperature).

Menu mask

An example of a menu mask is shown in the figure below:



Fig. 3.b

The top right corner shows the selected item. The & buttons are used to select the desired menu item, while accesses the selected item.

Screen for displaying/setting the parameters

An example of a mask for displaying/setting the parameters is shown in the figure, also highlighting the fields and icons used:



Fig. 3.c

1	Menu branch identifier
2	Screen identifier
3	Parameters

The mask identifier uniquely identifies the menu branch and the mask: the first characters indicate the menu branch, while the last two alphanumeric digits identify the order of the mask inside the menu, for example mask Bab01 is the first mask in menu B.a..

4. MENU DESCRIPTION

4.1 Main menu

To navigate inside the menu tree, use the following buttons:





- e : navigate around the submenus, masks and change values and settings;
- : confirm and save the changes made;
- : to return to the previous menu.

	A. Unit Status	a. Main Info b. Setpoint c. ON/OFF a. Status	a. Dig. In. b. Analog In. c. Dig. Out d. Analog Out
	B. Input/Output	b. Manual man. c. Test	a. Dig. Out b. Analog Out a. Dig. Out b. Analog Out
	C. Compressors	a. I/O status b. Regulation c. Op. hours d. Energy save e. Alarms f. Configuration g. Advanced	
	D. Condensers	a. I/O status b. Regulation c. EEV d. Energy save e. Alarms f. Configuration g. Advanced	
	E. Evaporators	a. Stato I/O b. Configuration c. Regulation d. EVD driver	
		a. Oil	a. I/O status b. Settings ****
		b. defrost	a. I/O status b. Settings c. info ****
		c. Economizer	not available
		d. Injection	a. I/O status b. Settings ****
		e. Heat recovery	not available
		f. Gen. functions	a. Stages b. Modulation c. Alarms d. Time bands e. I/O status
	F. Other functions	a. Clock	a. Time bands b. Settings
		b. Language	
		c. BMS	
	G. Configurations	d. Fieldbus e. Password	
	H. Safety	a. History	
		b. Prevent	not available
		c. Alarm configuration	
	I. Info		
		a. Pre-configuration	not available
		b. Wizard	
	L. Setup	c. Advanced config.	not available
		d. Default	

5. COMMISSIONING

5.1 Guided commissioning procedure

pRack Hecu can be setup the first time from the pGDe or pLDpro user terminal. If the controller has not yet been configured, the user terminal shows the first mask in a guided configuration procedure, called the "wizard". Otherwise, the same menu can be accessed from branch: L Setup >> b.wizard.

The main parameters needed for general configuration are shown one at a time. The wizard masks are all numbered in the top right corner; the following explanations refer to this number. To go from one mask to the next press , while to return to previous mask press .

Screen Lb01: indicates the type of system, either medium or low temperature.



Screen Lb03: indicates the type and number of compressors.

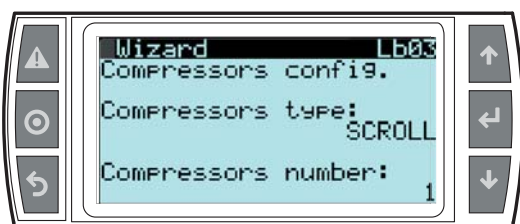

Screen Lb04: indicates the type of modulating device associated with the compressor selected on the previous mask.

Screen Lb05: indicates the model of BLDC compressor and the serial address of the power+ inverter (always=1). This is used to understand whether the inverter is on and connected via serial with pRack Hecu.

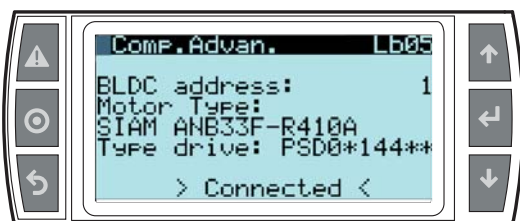

Screen Lb11: indicates whether the connected model of inverter is compatible and if so automatically downloads some typical compressor parameters to the inverter. The parameters can also be written manually by selecting "Yes" for Write default.

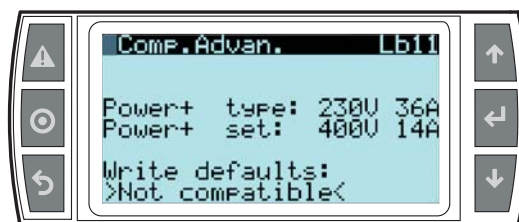

Important: wait a few seconds for the automatic default download procedure to start and conclude.

Screen Lb07: indicates the compressor control set point and differential set as default by CAREL based on the type of application and the refrigerant. The type of control is always proportional and integral, and when exiting the wizard, control will be fixed set point only until configuring communication with the cabinets, when the floating suction pressure set point can be enabled.

Screen Lb10: indicates that a backup compressor is enabled in the event of alarms on the main compressor.



Screen Lb91: indicates the number of fans. The maximum available is two fans.

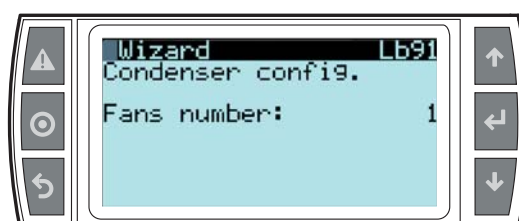

Screen Lb92: indicates the type of fans, either ON-OFF, PWM or 0-10V modulating.

Screen Lb96 Lb97: indicates the type of control and the working set point and differential.

Screen Lb93: indicates the end of the wizard procedure. Press ENTER to terminate the procedure, and start system configuration using the chosen settings.

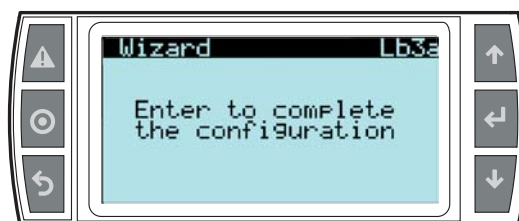

6. FUNCTIONS

6.1 Unit ON/OFF

The unit can be switched on and off from:

- User terminal
- Supervisor
- Digital input

On-off from the user terminal and the configuration parameters are available under the main menu, branch A.c.

On-off from the supervisor and from the digital input and start-up after a blackout (with specific delay, to avoid continuous starts and stops in the event of instability in the power supply) need be enabled.

On-off from the digital input is equivalent to an enabling signal, that is, if the digital input is Off the unit cannot be switched on in any other way, while if it is On, the unit can be switched on or off in any other way, with the same priority (the most recent has precedence, whatever the origin), as shown in the figure:

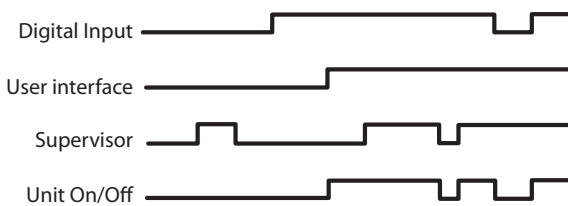

Fig. 6.a

Note: certain special conditions or functions in the pRack Hecu software cause the unit to shutdown:

- Configuration of some parameters: e.g. inputs/outputs, configuration of compressors, inverter parameters.
- Installation of default parameters
- Manual management

6.2 BLDC compressor

One Scroll BLDC compressor controlled via Power+ inverter can be selected. The type of compressor is chosen in Compressors → Configuration (Caf15).

The BLDC compressor is managed via Modbus and works only if connected to a CAREL power+ inverter. If there is no communication with the inverter, the compressor will not be able to operate.

Below is a list of currently available compressors:

Medium temperature

Compressor	Refrigerant	Complete P/N
SIAM ANB 33F-400V	R410A	ANB33FQFMTS
SIAM ANB 42F-400V	R410A	ANB42FQFMTS
SIAM ANB 52F-400V	R410A	ANB52FKFMTS
SIAM ANB 78F-400V	R410A	ANB78FVAMTS
SIAM ADB 66F-400V	R404A	ADB66F1-MTS
SIAM ADB 78F-400V	R404A	ADB78F1-MTS

Low temperature

Compressor	Refrigerant	Complete P/N
SIAM ANB 66FU-400V	R410A	ANB66FUFMTS

Important: pRack Hecu can also manage an optional backup compressor, which can operate in place of the main BLDC compressor in the event of faults or alarm.

Note: go to ksa.carel.com to check the updated list of compressors available, with reference to "DC compressor availability table"+050001835.

Manual configuration

pRack Hecu automatically downloads the optimised parameters for each model of compressor at the end of the wizard procedure.

If the model of compressor is changed or the power+ is replaced, the new system can be configured manually under the menu **Compressors** → **Advanced** → **screen Cag12**.

pRack Hecu and power+ must be powered and connected via serial; the address of power+ must be 1 (default).

The type of compressor is selected from the list of available compressors; the number of motor poles and the correct model of power+ are defined automatically.



Select YES for Set defaults and press ENTER.

If the model of power+ (as read by power+) is the same model or larger than the power+ selected based on the type of BLDC compressor, the default values can be written and pRack Hecu can control the compressor. Otherwise, the message "Not compatible" will be shown.

Envelope management

pRack Hecu defines the compressor working zone in the software based on the following measurements:

- Condensing pressure
 - Evaporation pressure
 - Discharge temperature
- and compares these against the compressor envelope.

The controller manages the demand for capacity sent to the inverter, in a controlled manner in order to maintain the compressor operating conditions within the limits of pressure and temperature defined by the manufacturer (zone 1a-1b). The actions to keep the compressor within the operating zone specified by the manufacturer are:

- Decrease in acceleration or deceleration, when compressor operation approaches the limits, until holding the speed when operation is at the limit.
- Speed reduction when operation is beyond the high condensing pressure or high compression ratio limits, so as to return within the permitted operating zone.

When compressor operation remains too long in a zone outside of the envelope, an alarm is generated (mask Cag55, default 60sec). The zone number and description is shown on the alarm mask.

During start-up, when the compressor operates at a fixed speed for the minimum ON time, this alarm is disabled.

The discharge temperature alarm is always active.

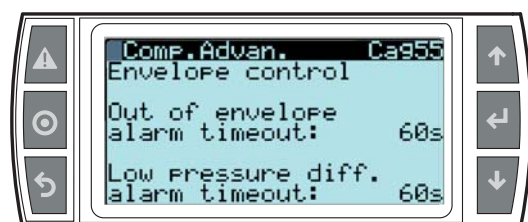

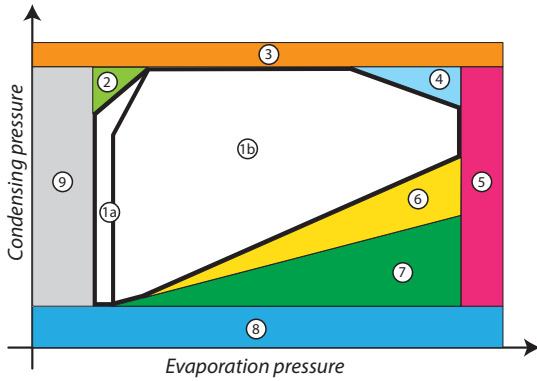

Fig. 6.b

The following zones are defined:

1. Inside the envelope (a, b with different maximum discharge temperature)
2. High compression ratio
3. High condensing pressure
4. High current
5. High evaporation pressure
6. Low compression ratio
7. Low pressure differential
8. Low condensing pressure
9. Low evaporation pressure

Start-up

pRack Hecu manages compressor start-up in the best way possible, adapting operating speed so as to guarantee that the desired conditions and excellent lubrication are reached very quickly.

For this reason, when starting the compressor is operated at a settable fixed speed (Cag52) for the minimum ON time, Fig. 6.c. During this stage, the out-of-envelope alarm is disabled, but speed control remains active if approaching or exceeding zone 2 (maximum compression ratio), 3 (maximum condensing pressure) or 4 (current limit).

The corresponding parameters are in loop: **Compressors → Advanced → masks Cag52:**

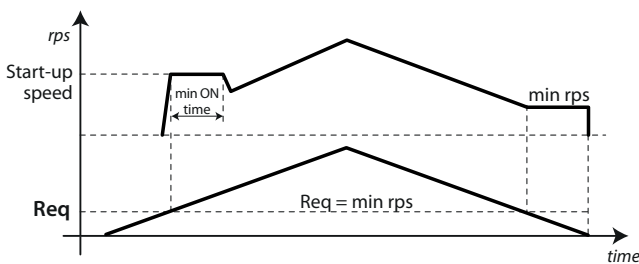
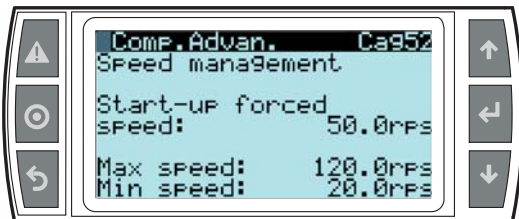
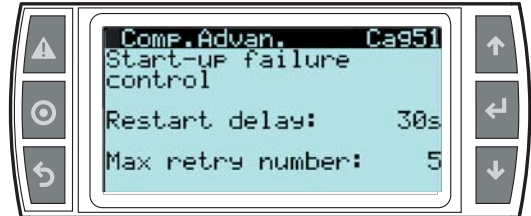
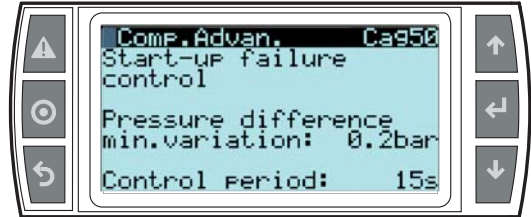

Fig. 6.c

If 15 seconds after compressor start-up, the pressure differential is less than 0.2 barg higher than the value measured at start-up, pRack Hecu stops the compressor and generates a "No compressor start-up" alarm. This alarm is automatically reset and pRack Hecu tries to start the compressor five times after a 30 second delay. After the fifth attempt, the alarm is no longer automatically reset.

The corresponding parameters are in loop: **Compressors → Advanced → masks Cag50, Cag51:**



Pressure differential during start-up

The BLDC compressor cannot start if the pressure differential is greater than a threshold defined by the compressor manufacturer. This limit depends on the maximum current delivered by the inverter. As soon as the pressure differential falls below the minimum threshold, the compressor can start.

The corresponding parameters are in loop: **Compressors → Advanced → mask Cag49:**

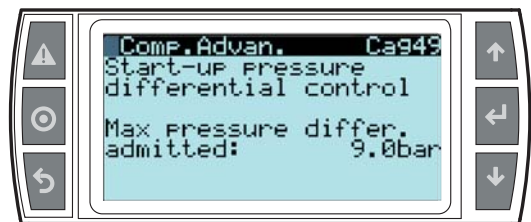

When the pressure differential is below 9 barg – 0.5 barg (fixed value), the compressor is ready to start.

Equalisation

pRack Hecu can exploit the oil injection valve to equalise pressure at start-up, meaning the condensing unit starts operating more quickly. If oil injection is managed by a solenoid valve, this function can be enabled on **mask Caf20**, while if injection is managed by electronic expansion valve, the exact valve opening can be set. These settings are all available on **mask Caf20** as shown below.

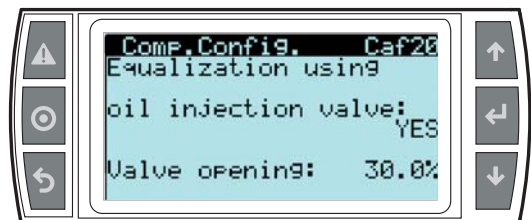

Minimum pressure differential for lubrication

The min. pressure differential threshold for correct lubrication is related to the type of BLDC compressor and cannot be modified. The low pressure differential alarm is generated when the difference between condensing pressure and evaporation pressure (DeltaP) remains below the limit defined by the compressor manufacturer for a set time, and consequently excellent lubrication is not guaranteed. The alarm stops the compressor and is reset automatically. The alarm is not active during defrosting.

The corresponding parameters are in loop: **Compressors → Advanced → screen Cag55.**

DSH control

pRack Hecu controls superheat on the compressor discharge line at the same time as superheat on the suction line.

If suction superheat is less than 0K and discharge superheat is less than 10K, a countdown starts to set off the corresponding alarm (DSH Low Liquid Flowback).

The alarm activation delay can be set on **mask Cae41** and can be differentiated for different stages of operation: compressor start-up, steady operation, defrost/washing active.

Times

Time management includes a minimum On time, a minimum Off time and a minimum time between two consecutive starts.

These parameters can be modified under **Compressors → Configuration → mask Caf17, Caf94:**

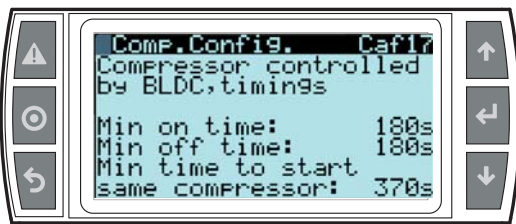

The logic is described in the following graph:

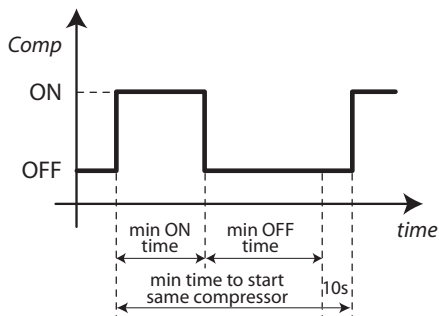

Fig. 6.d

6.3 Compressor control

Control can be proportional or proportional + integral (P, P+I). The corresponding parameters are in loop: **Compressors → Regulation → mask Cab14.**

The set point is in the centre of the band. Proportional control is illustrated in the following figure:

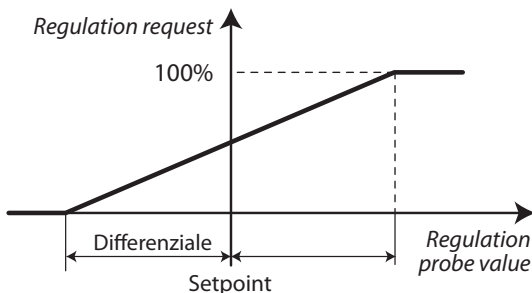

Fig. 6.e

With proportional + integral control, the integral time is summed to the effect of proportional control, giving a null control error in steady operation. This type of control is illustrated in the following figure:

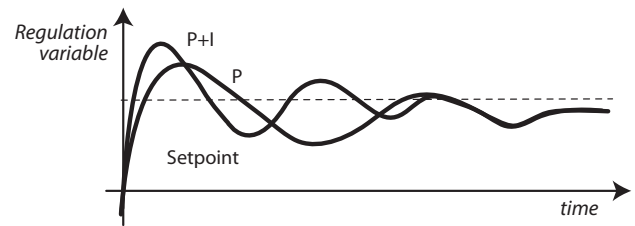

Fig. 6.f

The integral action depends on time and the deviation from the set point. The integral time represents how fast integral control is implemented:

- Low values bring fast actions yet more instability
- High values bring slower actions and more stability

The values should not be set too low, to avoid system instability.

Two types of control can be set, in loop **Compressors → Regulation → mask Cab01**

- Fixed set point
- Floating set point

Floating set point

This software function is available by exploiting serial communication with the evaporators. Serial communication allows information to be exchanged in real time between the main pRack Hecu controller and the MPXPRO devices.

Note: the MPXPRO controllers installed on the evaporators implement the Smooth Lines function (see MPXPRO manual +0300055). This function significantly reduces the number of ON-OFF cycles in traditional control by modulating the evaporator temperature using an electronic expansion valve and adapting the superheat set point using appropriate PI control based on the effective control temperature.

This function can be enabled and configured manually or automatically.

- The automatic procedure involves the Fast Commissioning operation described in chapter 7, which automatically configures the control parameters on both the condensing unit and the evaporators, using the default values optimised by CAREL, yet amply modifiable.
- To configure the function manually, make sure that there is a serial connection with the MPXPRO controllers on the evaporators, and choose the type of control on **mask Cab01**. The Smooth Lines function will then need to be configured on the MPXPRO controllers, as described in the next chapter.

The unit floating suction pressure set point can vary between a settable minimum and maximum value. The minimum and maximum limits for the floating set point are shown on **mask Cab18**, in line with the limits set on **mask Cab02**.

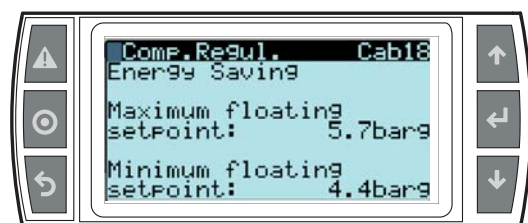

pRack Hecu uses an advanced algorithm to adapt the condensing unit suction pressure set point based on the request from each evaporator, then weighing it according to evaporator capacity. Significant variations in request due to certain evaporator operating states, such as defrost, are managed by pRack Hecu, maintaining fine, stable control.

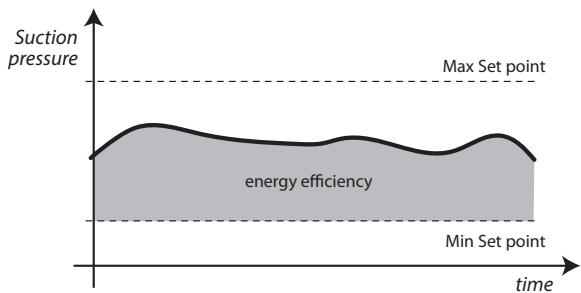

Fig. 6.g

Proportional + integral control will be used to reach the floating set point, based on parameters that can be set on **mask Cab14**. The following table shows the recommended parameters for PI control of the condensing unit:

PI	K	PSP: prop. gain	barg	12.0
Press reg	Ti	PSI: integral time	sec	50

6.4 Backup compressor

pRack Hecu can manage an optional backup compressor in the event of alarms or malfunctions on the main compressor. The backup compressor can be enabled on **mask Caf03** or during the wizard procedure.

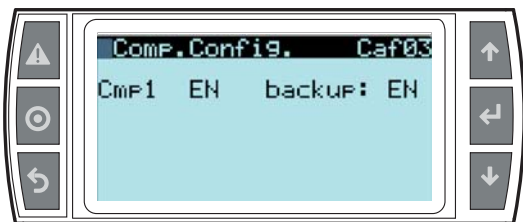

The backup compressor is a fixed-speed compressor connected to a digital output. Once put into operation, control is based on an activation and deactivation threshold can be set on **mask Cab17**.

The backup compressor output is activated following one or more alarm on the BLDC compressor within the so-called evaluation time. These parameters can be set on **masks Hca07 and Hca09**.

The backup compressor output is activated also in case of compressor alarm setted as serious on **masks Cae04 and Cae07**.

Oil injection remains active when the backup compressor is operating. In the event of calibrated injection based on BLDC compressor speed, a fixed value can be set for opening the valve when the backup compressor is activated, on **mask Faab25**, depending on the capacity of the backup compressor used. The default value (50%) is purely indicative.

In other cases, valve control remains unchanged.

! Important: once the backup compressor has been started, no procedures are available to return to BLDC compressor operation, therefore the main compressor needs to be repaired or replaced and then reactivated.

To ensure operation in case of failure of the control board, it is suggested to implement a secondary regulation of the fixed backup compressor through activation/deactivation with mechanical pressure switches.

6.5 Fans

pRack Hecu can manage up to two fans with a speed modulation device, which may be an inverter or a PWM phase control device. In the same way as for the compressors, fan control can be proportional or proportional plus integral, based on pressure or temperature.

Fan operation with modulating device

If the fans are controlled by a modulating device, the meaning of the parameters that associate the minimum and maximum values of the device's modulating output and the minimum and maximum capacity of the modulating device on masks Dag02 and Dbg02 is illustrated in the following examples.

Example 1: minimum modulating output value 0 V, maximum value 10 V, minimum modulating device capacity 0 %, maximum value 100 %.

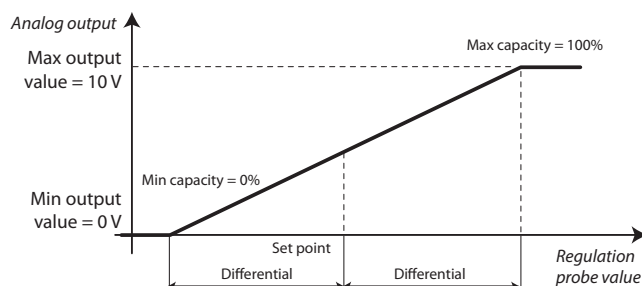

Fig. 6.h

Example 2: minimum modulating output value 0 V, maximum value 10 V, minimum modulating device capacity 60 %, maximum value 100 %.

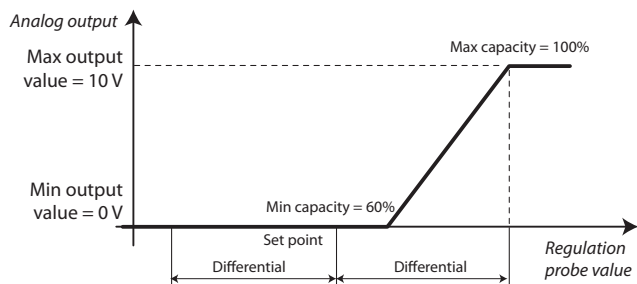

Fig. 6.i

Example 3: minimum modulating output value 2 V, maximum value 10 V, minimum modulating device capacity 60 %, maximum value 100 %.

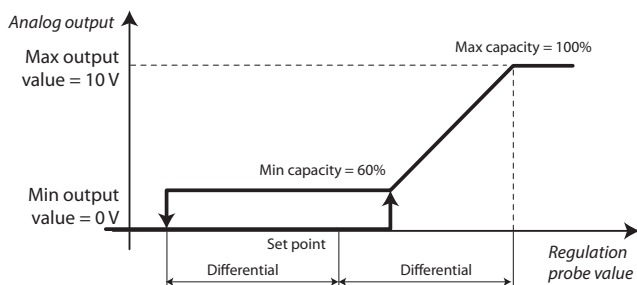

Fig. 6.j

Cut-off

pRack Hecu manages a cut-off control function for the fans; the function can be enabled and the related parameters set in main menu branch D.a.b/D.b.b. The operating principle of the cut-off function is shown in the figure:

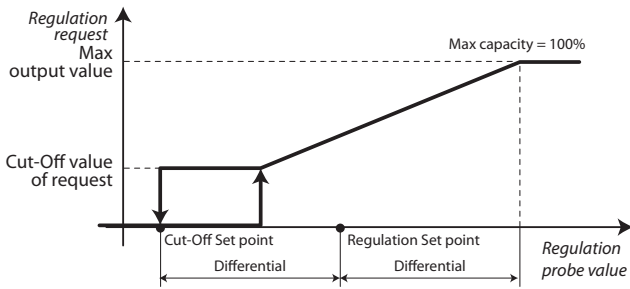

Fig. 6.k

A percentage of the control request and a cut-off set point can be set. When the control request reaches the set cut-off value, this value is kept constant until the control value falls below the cut-off set point, after which it falls to 0% and remains there until the request exceeds the cut-off value again.

Speed up

pRack Hecu can manage the fast start function (speed up), used to overcome the initial inertia of the fans. The function can be enabled and the related parameters set in main menu branch D.a.g/D.b.g.

If speed up is enabled, a start time can be set in which the fan speed is forced to 100%. If the outside temperature sensor is used, moreover, a threshold can be set (with reset differential) below which speed up is disabled, so as to not drastically lower the condensing pressure at start-up.

Floating condensing pressure set point

For the condenser line, the floating set point is based on the outside temperature. The floating condensing pressure set point is achieved by adding a constant programmable value to the outside temperature and limiting the resulting value between a settable minimum and maximum, as shown in the figure:

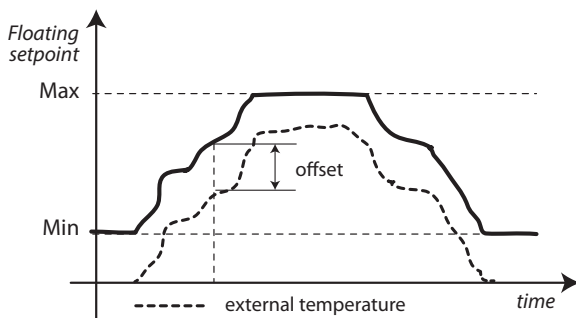

Fig. 6.l

6.6 Oil management

Oil injection

Oil return is a critical factor when using BLDC compressors. pRack Hecu can manage three different solutions for injecting return oil to the compressor. The related configurations can be set on **mask Fab15**.

Capillary valve

The simplest solution is to use a capillary valve, with fixed opening, calibrated based on rated conditions. This solution however creates inefficiencies, by injecting or less oil than required by the compressor.

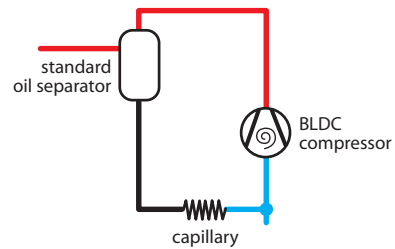

Fig. 6.m

Electronic expansion valve (EEV COMP SPEED)

This solution involves a CAREL expansion valve. The valve opening is calibrated based on BLDC compressor operating conditions, adjusted proportionally according to its speed.

In order to use this function, a standard oil separator can be installed. The control algorithm is represented in the following graph, and the parameters can be configured on **mask Faab18**.

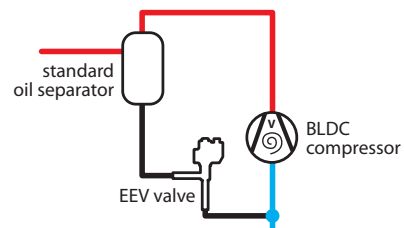

Fig. 6.n

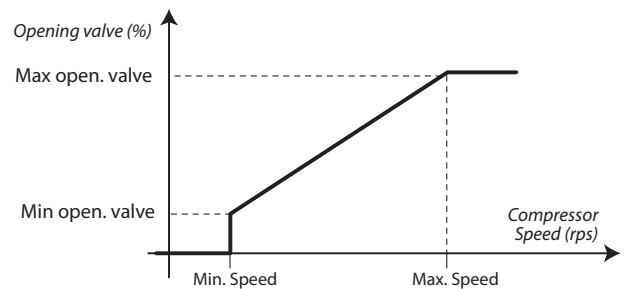

Fig. 6.o

Electronic expansion valve (EEV LEVEL MNG)

This solution involves a CAREL expansion valve. The valve opening is calibrated based on normal system operating conditions. This solution is very efficient from an energy viewpoint, as it injects the exact quantity of oil needed by the compressor. In order to use this function, an advanced oil separator needs to be installed, featuring a level sensor that defines three states via two digital inputs, configurable on **masks Faaa55, Faaa56**. An advanced algorithm calculates valve opening based on the time that elapses between the various states, comparing this against the previous measurements. The objective is to replicate the oil level inside the compressor by measuring the amount in the separator and keeping this level stable over time.

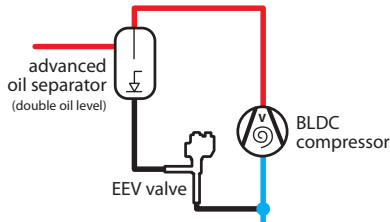

Fig. 6.p

In **mask Faab20** you can configure two preventive thresholds for high and low oil level (Emergency HL and LL). If oil remains at that level for the set time, the valve will open to maximum (case HL) or to minimum (if LL) moving to 1 step/sec.

Oil speed boost

This function boosts the return of oil by operating the compressor at a fixed speed for a set time, thus recovering the oil spread along the refrigerant circuit.

This override function is activated if the following conditions are true, see **masks Faab15, Faab23**:

- Speed boost : YES
- Compressor speed < minimum threshold
- The previous conditions last for a set time

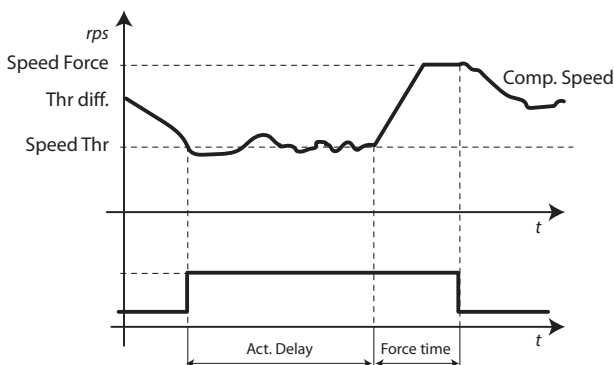
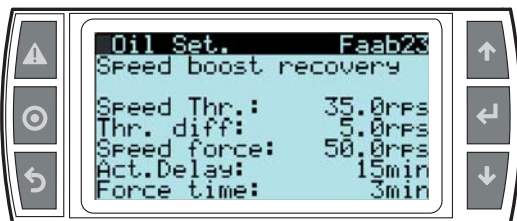
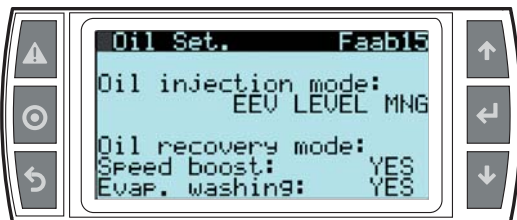

Fig. 6.q

Oil recovery washing

Another function available on pRack Hecu to assist oil return to the compressor involves washing the evaporators. This function uses serial communication between pRack Hecu and the MPXPRO controllers, and the electronic expansion valves on the evaporators.

The oil recovery washing function sets the superheat set point to 0K for a settable time t1 [default 3 minutes] in order to retrieve the oil spread along the refrigerant circuit; the valve will thus open further, “washing” the evaporator and flushing the accumulated oil back the compressor.

Note: to make this function more effective, the electronic expansion valve on the evaporator opens fully at the start of the recovery washing cycle and then its position is controlled automatically based on the new superheat set point.

td is the time at the end of a washing cycle for which compressor speed remains fixed, and valve opening returns to the same position as prior to activation of the function [default 2 minutes]. If this value is set to 0, at the end of a washing cycle the system will restart without overriding compressor speed and keeping the valve at the previous opening position for a set time.

During a washing cycle, the following conditions are set:

- Oil recovery washing: ON
- Smooth Line: OFF
- P3: 0K
- P7: -10K
- St: -50°C

The following diagram explains operation and control of the electronic expansion valve and the superheat set point:

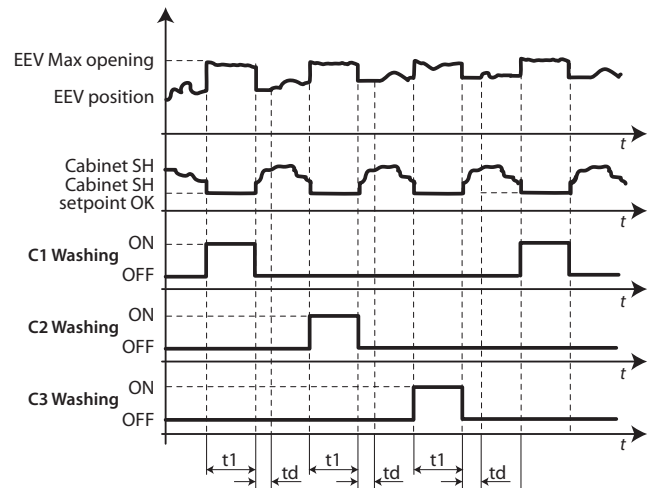

Legende:
t1= time ON **td**= Fixing time function

Fig. 6.r

Washing of individual cabinets can be configured exclusively as sequential mode.

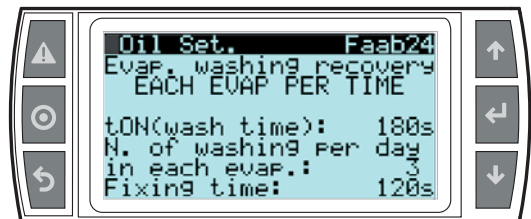

tON is the duration of each single washing.
 “N. of washing per day in each evap.” is the number of washing per day for each evaporator.
 Fixing time is the transition time at the end of each single washing to keep the system in stable condition.

6.7 High discharge temperature management

The envelope of a BLDC compressor is also limited by high discharge temperature. Near the limit value, compressor speed will start slowing, until stopping on reaching the limit. If the temperature continues to rise, a safety algorithm will be activated to gradually reduce it. The corresponding parameters are under submenu: **Compressors** → **Advanced** → **mask Cag57, Cag58, Fdab04**.

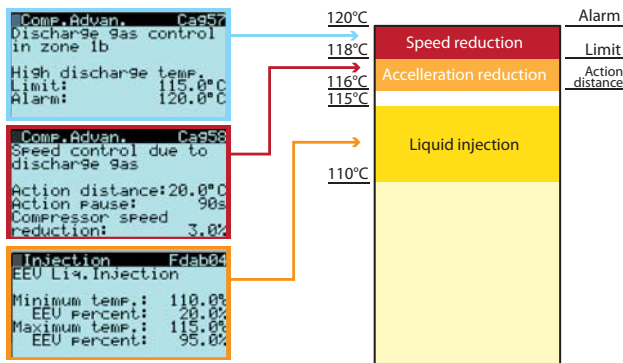

Fig. 6.s

If the discharge temperature exceeds the maximum limit, the high temperature alarm is activated and the compressor is stopped. The alarm is reset manually.

6.8 Liquid injection

The liquid injection function is used to protect the compressor; the aim is to lower discharge temperature. The corresponding parameters are under submenu: **Other functions** → **Injection** → **settings** → **mask Fdab01, Fdab05**.

Liquid injection can be performed using a solenoid valve plus capillary or electronic expansion valve.

Capillary and solenoid valve

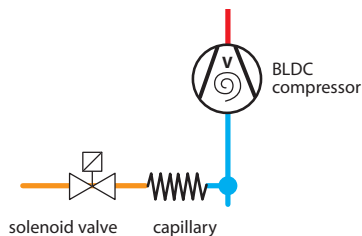

The solenoid valve opens when exceeding a set threshold, and closes after falling below a set differential, **mask Fdab01, Fdab05**.

Electronic expansion valve

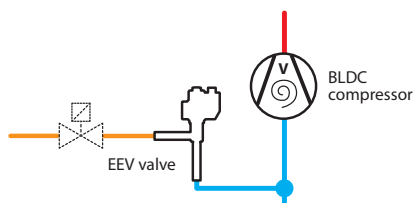

This function associates the minimum and maximum discharge temperature values to the minimum and maximum valve opening values, as illustrated below, on **mask Fdab04**.

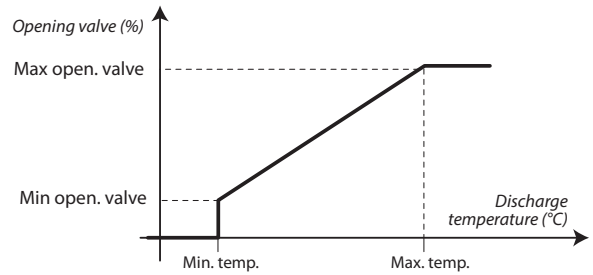

Fig. 6.t

! Important: liquid injection is only available for medium temperature systems. Low temperature systems feature vapour injection.

! Important: it is suggested to install in series with the EEV valve a solenoid valve to block the flow of refrigerant to the compressor in case of power failure.

6.9 Vapour injection

Vapour injection is an essential function on low temperature compressors designed to be fitted with an economizer. The economizer can be activated using a subcooling circuit, similar to the one illustrated in the figure below.

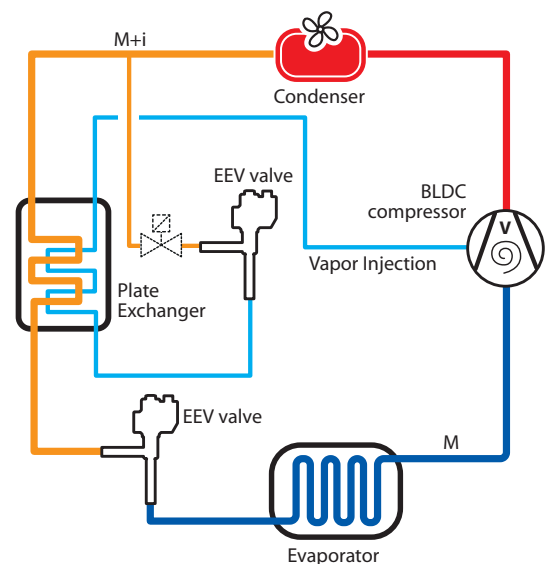

Fig. 6.u

This function is used to increase system cooling capacity and efficiency. Vapour injection into the compressor is managed using an electronic expansion valve. Valve opening is controlled in two modes, according to a discharge temperature threshold. Below this temperature threshold, control is performed by measuring superheat, while above the threshold valve opening varies directly according to discharge temperature.

Superheat control

The EEV valve controls subcooled refrigerant flow out of the condenser and into the heat exchanger. Minimum subcooling must be guaranteed at the EEV valve inlet to avoid flash gas.

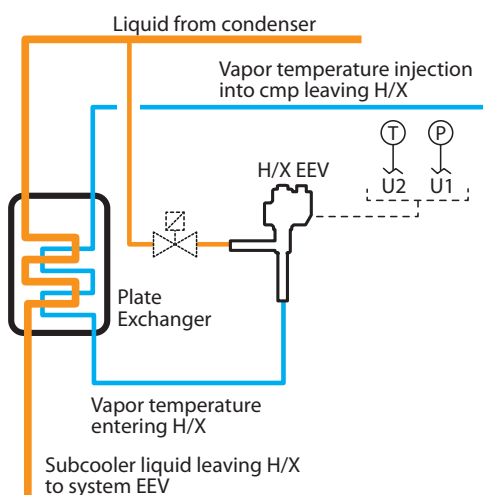

Fig. 6.v

This function is only available for low temperature systems. Injection superheat is calculated as the difference between saturated injection temperature (calculated by converting the pressure at the end of the heat exchanger) and the superheated gas temperature (measured by the temperature probe at the heat exchanger outlet). The expansion valve must be controlled with extreme precision, based on a superheat set point defined by the user. The parameters can be set on **mask Fdab06**.

Note: it is possible to use a backup compressor also for low temperature application. The vapour injection valve is injecting directly in the compressor so in this case it is necessary to install also two solenoid valves to drive the vapour flow in the compressor running.

Discharge temperature control

When discharge temperature exceeds the limit value, the system operates in high discharge temperature mode, and the valve is opened more intensely. The higher the discharge temperature above a certain threshold, the more the electronic valve opens. pRack Hecu defines the discharge temperature set point in accordance with the operating limits defined by the envelope.

Valve operation is represented in Figure 6.t. Minimum valve opening corresponds to the value read at the instant when reaching the minimum discharge temperature, while maximum opening is settable on **mask Fdab04**, as are the minimum and maximum discharge temperature thresholds.

6.10 Defrost

As well as the two traditional types of defrost managed by MPXPRO, static or heater, pRack Hecu can also manage another type of defrost for medium temperature systems, by increasing the condensing unit working set point.

The type of defrost is selected in the loop: **Other functions → Defrost → Regulation → mask Fbab01**.

Defrost with saturated temperature modulation

(managed by pRack Hecu)

For the suction line, the floating set point is managed by pRack Hecu. To manage defrosts with saturated temperature modulation, the suction pressure set point is increased to a settable value.

The function performs a series of daily defrosts, defined by the ON time (Active Ton) and the OFF time (Not Active Toff). pRack Hecu automatically schedules all the defrost at regular intervals over 24 hours.

This operation is illustrated in the following figure:

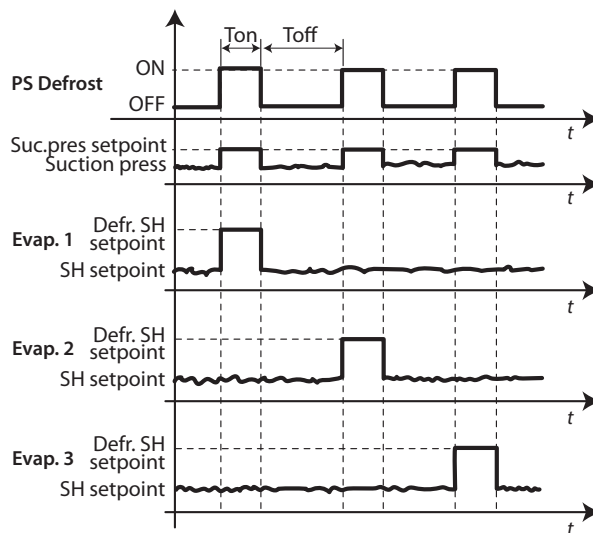

Fig. 6.w

Active Ton: time this type of defrost is active for

Not Active Toff: time this type of defrost is not active for

To make defrosting more effective, the superheat set point on each evaporator is sequentially increased to a settable value (defrost SH set point), as shown in the previous diagram.

The corresponding parameters are in the loop: **Other functions → Defrost → Regulation → mask Fbab02**.

If the suction pressure doesn't reach the defrost setpoint and the compressor speed is at the minimum value for a period equivalent to the "evaluation time" setted in **mask Fbab14**, it is possible to start the pump-down phase. This function have to be enabled in the same mask.

This procedure closes all the valves of the evaporators and when the suction pressure reaches the pump-down pressure it switches OFF also the compressor.

This defrost will end by time or by temperature when all the evaporators will reach the temperature to end the defrost, settable in **mask Fbab14**.

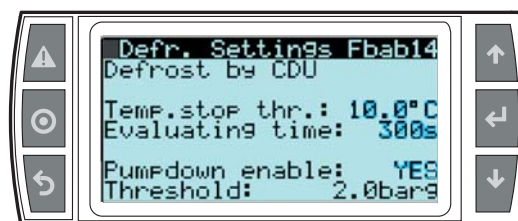

Static defrost

(managed by MPXPRO)

This function can be configured on MPXPRO. For further details, see manual +0300055EN.

Heater defrost

(managed by MPXPRO)

This function can be configured on MPXPRO. For further details, see manual +0300055EN.

6.11 Generic functions

pRack Hecu can use the free inputs / outputs and certain internal variables for a number of generic functions.

The following generic functions are available for each board:

- 5 stages
- 2 modulation functions
- 2 alarms

Each function can be enabled/disabled by digital input and on the user interface. The generic functions can be enabled and the related parameters set in main menu branch E.f. To be able to use the free inputs, these first need to be configured as generic from probes A to E (analogue inputs) and general inputs from F to J (digital inputs), after which a maximum of five analogue inputs and five digital inputs can be used. After having configured the generic probes, the associated variables can be used as control variables, and the digital inputs to enable the functions. As well as the generic probes and inputs, other internal variables in the pRack Hecu software can be used, depending on system configuration.

Examples:

for analogue variables:

- Suction pressure
- Condensing pressure
- Saturated suction temperature
- Saturated condensing temperature
- Suction temperature
- Discharge temperature
- % of compressors active
- % of fans active
- Superheat
- Subcooling
- Liquid temperature,
- % compressor request
- % fan request

for digital variables:

- High suction pressure alarm
- Low suction pressure alarm
- High condensing pressure alarm
- Sign of life

Each generic function can be assigned a unit of measure and a description. Below are descriptions of how the three types of generic functions work.

Stages

pRack Hecu can manage up to five stage functions, with either direct or reverse operation. In both cases, a set point and a differential can be defined; operation of the corresponding output is shown in the figure below, for both two cases:

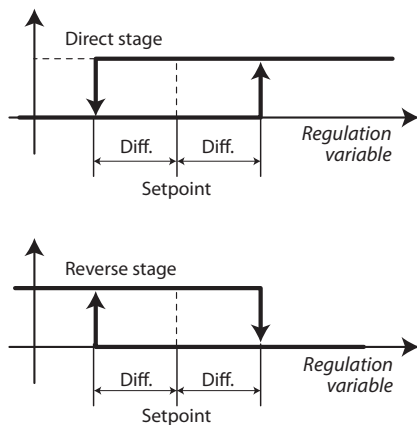

Fig. 6.x

If a variable has been set to enable the function, the output connected to the stage will be active when the enabling variable is active. For each stage, there is a high alarm threshold and a low alarm threshold, both absolute values. For each alarm, the activation delay and priority can be configured.

Modulation

pRack Hecu can manage two modulation functions, with either direct or reverse operation. In both cases, a set point and a differential can be defined; operation of the corresponding output is shown in the figure for direct operation, with the cut-off function also enabled:

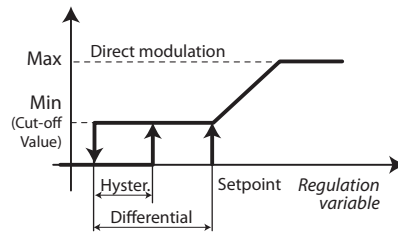

Fig. 6.y

If a variable has been set to enable the function, the connected output will be active when the enabling variable is active. For each modulation function, there is a high alarm threshold and a low alarm threshold, both absolute values. For each alarm, the activation delay and priority can be configured. A minimum and maximum value of the modulation output can also be set, and the cut-off function enabled, which works as shown in the previous figure.

Alarms

pRack Hecu can manage two alarm functions, by configuring the digital variable to be monitored, the activation delay, the priority and an optional description. Each generic alarm function can be associated with a digital output for activating external devices when the alarm occurs. One example of a generic alarm functions is detecting gas leaks.

6.12 Default value management

pRack Hecu can manage two different sets of default values:

- user defaults
- Carel defaults

Either of the two sets can be activated from the main menu branch I.d.

! Important: after having reset the default values, the pRack Hecu board needs to be powered off and on again.

Saving and restoring the user default values

pRack Hecu can save on the controller the exact configuration set by the user and then reload it at any time.

All of the set values are saved, therefore loading the user defaults restores the exact same conditions of the pRack Hecu controller at the moment the values were saved.

➡ Note: only one user default configuration can be saved, therefore if saving the values another time, the new values overwrite the previous ones.

! Important:

- the procedure for resetting the Carel default values involves clearing the permanent memory on the pRack Hecu, therefore the operation is irreversible;
- the user values cannot be reloaded if updating the software on the pRack Hecu board. In this regard, see chap. 10, which describes how to save the parameters for different versions of software

Loading the Carel default values

The values pre-defined by Carel can be loaded at any time, restoring the pRack Hecu default settings, and therefore repeating the start-up procedure described previously.

! Important: the procedure for resetting the Carel default values involves clearing the permanent memory on the pRack Hecu, therefore the operation is irreversible.

➡ Note: to repeat the wizard procedure, first restore the Carel default values.

7. FAST COMMISSIONING

The Fast Commissioning function is an automatic procedure to assist installers in the final configuration of the entire system: condensing unit connected via serial line to a maximum of five MPXPRO controllers. Once having configured the condensing unit, the MPXPRO controllers installed on the evaporators need to be configured, and then the entire system comprising the combination of both.

! Important: before configuring the entire system, make sure the cabinets are fitted with MPXPRO controllers and EEV electronic expansion valves.

7.1 MPXPRO configuration

General connection diagram

It is recommended to follow the general connection diagram shown here, so as to simplify the subsequent controller configuration stage by exploiting many of the pre-defined parameters.

Warning: Before making any operation on the control board, turn off the supply mains turning off the main switch of the electrical panel.

! The contemporary operation of both outputs is not granted with any actuator. Please refer to the technical features.

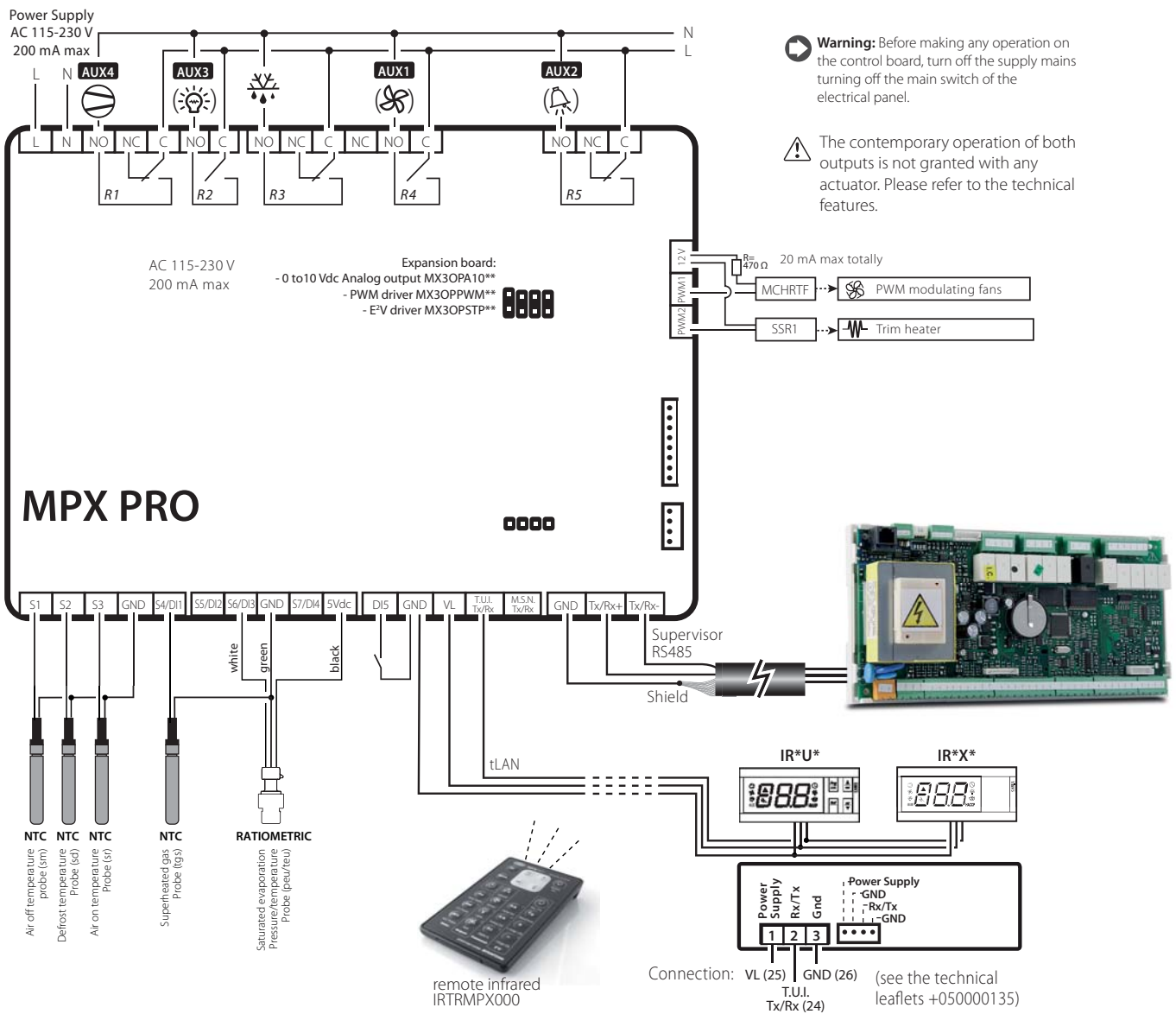

Fig. 7.a

Once having completed the wiring, simply follow the guided procedure that is shown when first starting the MPXPRO controllers. Below is a description of the procedure; for further information, see the MPXPRO manual +0300055EN rel. 1.4 of 16/02/2015.

Guided commissioning procedure

When first started, MPXPRO opens a guided procedure that helps the user set the main parameters for the configuration of the electronic valve and the serial network.

Commissioning parameters

Par.	Description
/P2	Type of probe, group 2 (S4, S5)
/P3	Type of probe, group 3 (S6)
/Fd	Assign tGS (superheated gas temperature probe)
/FE	Assign PEu/tEu (saturated evaporation pressure/temperature probe)
/U6	Maximum value of probe 6
/L6	Minimum value probe 6
P1	Electronic valve
PH	Type of refrigerant
In	Type of unit
Sn	Number of slaves in the local network
H0	Serial or Master/Slave network address

Tab. 7.a

The parameters can be set from the user terminal or the remote control. If using the remote control, a terminal with display and infrared (IR) port is required.

After powered on the controller:

1. the first parameter is displayed: /P2 = Type of probe, group 2 (S4, S5);
2. press Set to display the value of the parameter;
3. press UP/DOWN to modify the value;
4. press Set to confirm, the "spanner" icon is no longer shown, indicating that the setting has been performed;
5. press UP and repeat steps 2, 3 and 4 for the following parameters, /P3, /Fd, /FE, /U6, /L6, P1, PH, In, Sn, H0;
6. press Prg/mute for 5 seconds to exit the guided commissioning procedure.



Fig. 7.b

/P2: Type of probe, group 2 (S4,S5)

Selects the type of temperature probe for inputs S4, S5.

Par.	Description	Def	Min	Max	UOM
/P2	Type of probe, group 2 (S4, S5) 0 = Standard NTC range -50T90 °C 1 = Standard PTC range -50T150 °C 2 = Standard PT1000 range -50T150 °C 3 = Standard NTC L243 range -50T90 °C	0	0	3	-

Tab. 7.b

Note: NTC L243/PTC/PT1000 probes can only be set in the full optional models or models with EEV driver. To assign the functions to the other probes, see parameters /FA, /Fb, /Fc, /Fd, /FE, /FF, /FG, /FH, /FI, /FL, /FM. For probe calibration, see parameters /c4,/c5.

/P3: Type of probe, group 3 (S6)

Selects the type of temperature or ratiometric pressure probe for input S6.

Par.	Description	Def	Min	Max	UOM
/P3	Type of probe, group 3 (S6) 0 = Standard NTC range -50T90 °C 1 = Standard PTC range -50T150 °C 2 = Standard PT1000 range -50T150 °C 3 = Standard NTC L243 range -50T90 °C 4 = 0 to 5 V ratiometric probe	0	0	4	-

Tab. 7.c

Note: TC L243/PTC/PT1000 can only be set in the full optional models or models with EEV driver.

/Fd: Assign tGS (superheated gas temperature probe)

Assigns the probe used to measure the superheated gas temperature at the evaporator outlet.

Par.	Description	Def	Min	Max	UOM
/Fd	Assign tGS (superheated gas temperature) 0 = Func. disabled 6 = Probe S6 1 = Probe S1 7 = Probe S7 2 = Probe S2 8 = Serial probe S8 3 = Probe S3 9 = Serial probe S9 4 = Probe S4 10 = Serial probe S10 5 = Probe S5 11 = Serial probe S11	0	0	11	-

Tab. 7.d

/FE: Assign PEu/tEu (saturated evaporation pressure/temperature probe)

Assigns the probe used to measure the saturated evaporation pressure/temperature, which by default is the probe connected to input S6. It is recommended to use the 0 to 5 Vdc ratiometric probe.

Par.	Description	Def	Min	Max	UOM
/FE	Assign PEu/tEu (saturated evaporation pressure/temperature probe) See /Fd	0	0	11	-

Tab. 7.e

/U6, /L6: Maximum / minimum value of probe S6

Parameters /L6 and /U6 are used to set the maximum and minimum limits for the range of measurement of the probe connected to input S6.

Par.	Description	Def	Min	Max	UOM
/U6	Maximum value of probe 6	9.3	/L6	160	barq, RH%
/L6	Minimum value probe 6	-1.0	-20	/U6	barq, RH%

Tab. 7.f

P1: Type of expansion valve

MPXPRO can control the CAREL E2V electronic valve. The CAREL electronic expansion valve is required in the Hecu sistema, and therefore this parameter must always be set to "2".

Par.	Description	Def	Min	Max	UOM
P1	Electronic valve 0 = not present 1 = PWM valves 2 = CAREL E ² V valve	0	0	2	-

Tab. 7.g

PH: Type of refrigerant

The type of refrigerant is essential for calculating superheat. It is also used for calculating the evaporation and condensing temperature based on the pressure probe reading. The following table shows the refrigerants that are allowed and corresponding compatibility with the CAREL E²V valve.

Par.	Description	Def	Min	Max
PH	Type of refrigerant 0 = Custom gas 13 = R1270 1 = R22 14 = R417A 2 = R134a 15 = R422D 3 = R404A 16 = R413A 4 = R407C 17 = R422A 5 = R410A 18 = R423A 6 = R507A 19 = R407A 7 = R290 20 = R427A 8 = R600 21 = R245Fa 9 = R600a 22 = R407F 10 = R717 23 = R32 11 = R744 24 = HTR01 12 = R728 25 = HTR02	3	0	25

Tab. 7.h

In: Type of unit

Parameter In assigns the controller the function of Master or Slave. Hecu sistema only accepts MPXPRO master controllers, therefore this parameter must always be set to "1".

Par.	Description	Def	Min	Max	UOM
In	Type of unit: 0 = Slave; 1 = Master	0	0	1	-

Tab. 7.i

Sn: Number of slaves in the local network

This parameter tells the Master controller how many Slave controllers need to be managed in the local network. Hecu sistema only accepts MPXPRO master controllers, therefore this parameter must always be set to "0".

Par.	Description	Def	Min	Max	UOM
Sn	Number of slaves in the local network 0 = no Slaves	0	0	5	-

Tab. 7.j

H0: Serial or Master/Slave network address

Parameter H0 indicates the MPXPRO serial address.

Par.	Description	Def	Min	Max	UOM
H0	Serial or Master/Slave network address	199	0	199	-

Tab. 7.k

The addresses must follow a logical order, starting from "2" and increasing sequentially.

Device	Address
MPXPRO 1	11
MPXPRO 2	12
MPXPRO 3	13
MPXPRO 4	14
MPXPRO 5	15

End of the procedure

Press Prg/mute for 5 seconds to exit the guided commissioning procedure.

7.2 Connecting MPXPRO to pRack Hecu

Once having completed the configuration of the MPXPRO controllers, the serial network needs to be connected, as shown in the following diagram:

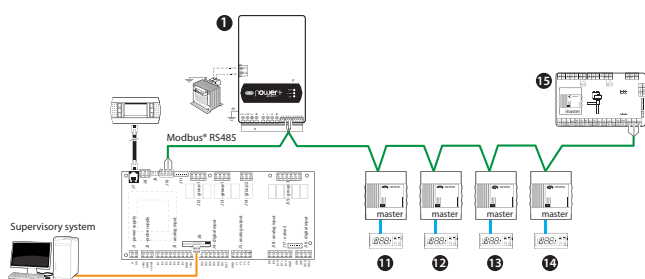

To subsequently configure the entire system made up of the pRack Hecu and MPXPRO controllers, see the Fast Commissioning procedure described in detail in the following section.

Fast commissioning

The Fast Commissioning procedure can be accessed from the menu: **Evaporators → Configuration → mask Eab01.**

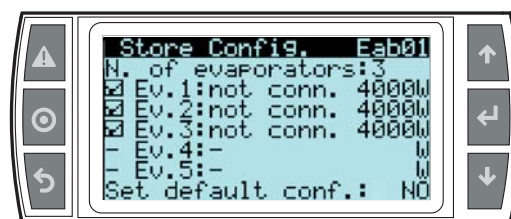

The procedure comprises the following steps:

1. Select the number of evaporators
2. Verify evaporator connection
3. Set the capacity of each evaporator
4. Download the default parameters

1. Select the number of evaporators

A maximum of five evaporators can be selected. Once having selected the number of evaporators, a new row will be shown for each of these, with the "V" checkmark on the left to indicate that the evaporator has been enabled.

2. Verify evaporator connection

After having enabled the evaporators, wait a few seconds to make sure their status changes from "not conn." to "Connected". If all the evaporators are connected, it means that the serial network has been configured correctly, otherwise check the physical connection of the devices with reference to the connection diagram shown in paragraph 2.7, and check the serial addresses set on the MPXPRO (parameter H0), according to the table also shown in paragraph 2.7.

3. Set the capacity of each evaporator

In order to maximise the results obtainable in terms of energy savings with the Floating Suction function, it is recommended to set the effective capacity of each evaporator.

4. Download the default parameters

Downloading the default parameters involves automatic configuration of the following functions:

- Floating suction pressure set point (Par. 6.3): the default values enable compressor control with floating set point on mask Cab01. The minimum and maximum set point values will be displayed automatically, in accordance with the type of refrigerant and application selected, together with the proportional gain and integral time values required by the controller and already shown in paragraph 6.3.
- Oil Recovery Washing (Par. 6.6): the default values enable the evaporator oil recovery washing function on mask Faab15. The following parameters manage this function:

Par.	Description	Def
tON	Washing cycle duration	180sec
tOFF	Time between two washing cycles	180min
Mode	Sequential or same time	SINGLE CABINET AT TIME
Fixing time	Stabilisation time after washing	120sec

Tab. 7.l

- Evaporator control parameters: the default values enable Smooth Lines evaporator control and involve the main evaporator control parameters on masks Eab01, Eab02, Eab03. These values are shown in the table below:

Par.	Description	Def
P3	Superheat set point	10
P4	Control valve: Proportional gain	8
P5	Control valve: Integral time	400
P6	Control valve: Derivative time	0
P7	Low superheat threshold	3
PSM	Enable Smooth Lines	Enable
Plt	Offset to stop control below set point (Smooth Lines)	4
Phs	Maximum superheat offset (Smooth Lines)	9
PSP	Smooth Lines: Proportional gain	3.0
PSI	Smooth Lines: Integral time	360.0
PSD	Smooth Lines: Derivative time	0.0

Tab. 7.m

Note: all the values indicated as defaults by the Fast Commissioning procedure can be modified so as to optimise operation of the entire system. It is recommended to change one parameter at a time and then evaluate the effects over a period of no less than 10 minutes.

7.3 MPXPRO control

Once having connected the MPXPRO controllers to pRack Hecu, the control parameters will be as follows, masks Eac01, Eac02, Eac03.

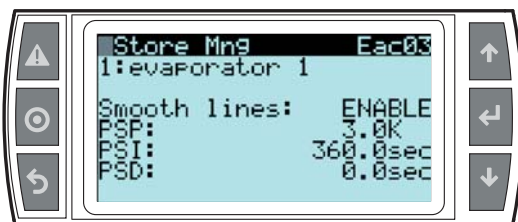

Electronic valve control

The superheat control function calculates the valve position based on the current superheat reading and set point. PID control (Proportional, Integral, Derivative) is the sum of three distinct actions:

Proportional action (P) parameter K=proportional gain:

The proportional action opens or closes the valve by K steps when superheat increases or decreases by 1°C. Thus the greater the K the higher the response speed of the valve to variations in superheat. The proportional action is fundamental as it affects the speed of the valve in general.

However it only considers variations in superheat and not the variation in relation to the set point. If superheat does not vary significantly, the valve will remain stable and the superheat set point may not be reached.

Integral action (I) parameter Ti=integral time (sec):

The integral action is linked to time and moves the valve in proportion to the deviation of the superheat value from the set point. The greater the deviations, the more intense the integral action; in addition, the lower the value of the integral time (Ti), the more intense the action will be. The integral action is necessary to ensure that superheat reaches the set point.

Derivative action (I) parameter Td=derivative time (sec):

The derivative action is linked to the speed of variation of the superheat value, that is, the gradient at which the superheat changes from instant to instant. It tends to react to any sudden variations, and has greater effect the higher the values of Td.

Selecting the superheat set point and control parameters

The superheat set point needs to be defined based on the design specifications of the controlled unit. Despite this, based on actual system conditions, this may be changed at any time. A low set point ensures better evaporator efficiency and a low air temperature can be reached more easily. In contrast, instability can be created in the system, with greater variations in superheat and liquid returning to the compressor.

A high set point ensures high system stability and lower variations in superheat. However evaporator efficiency is penalised and the air temperature set point may not be reached.

As regards the control parameters, the following can be used as a guide:

Proportional gain (from 3 to 30)

Increasing the proportional gain K increases valve response speed and is recommended if the system is particularly perturbed or to make superheat control faster. If greater than 20, it may cause swings and instability.

Integral time (from 40 to 400 sec)

Increasing the integral time Ti improves stability but makes the valve slower to respond in reaching the set point. If less than 40 sec, it may cause swings and instability. If the system is already perturbed, high values (greater than 150 sec) are recommended to avoid creating further disturbance.

Derivative time (from 0 to 10 sec)

Increasing the derivative time Td improves valve response, in particular in perturbed systems, and reduced the amplitude of swings in superheat. If greater than 10 sec it may cause excessively fast response and consequently instability.

Smooth Lines function

The Smooth Lines function is used to optimise evaporator capacity based on actual cooling demand allowing more effective and stable control of the cabinet. This function completely eliminates traditional on/off control, modulating cabinet temperature exclusively by using the electronic valve, adjusting the superheat set point with accurate PI control based on effective control temperature.

The main features are:

- The superheat set point for managing the electronic expansion valve can vary between a minimum (traditional set point P3) and maximum limit (P3+PHS: maximum offset) using PI control (pre-configured), based on the control temperature and how far this is from the corresponding set point St
- The temperature inside the cabinet can fall slightly below the set point St, without stopping the main control, however simply closing the electronic valve
- Temperature control (and consequently the solenoid valve relay) therefore remains active at all times, while the electronic expansion valve stops the flow of refrigerant into the evaporator
- It is easy to use, as it is the instrument itself that automatically adapts control based on current operation, without requiring special parameter settings.

The main benefits are:

- No swings in temperature and superheat when reaching the set point
- Stable temperature and superheat control
- Maximum energy savings by stabilising the load

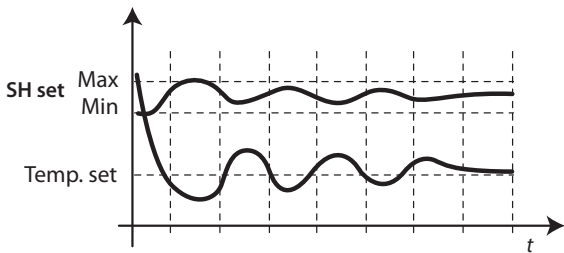

Fig. 7.c

Par	Description	Def	Min	Max	UM
PSM	Smooth Lines - Enable function	0	0	1	
PLt	Smooth Lines - Offset to stop control below set point	2.0	0.0	10.0	°C/°F
PHS	Smooth Lines - Maximum superheat offset	15.0	0.0	50.0	K

LowSH Low superheat protection.

To prevent too low superheat values that may cause the return of liquid to the compressor or system instability (swings), a low superheat threshold can be defined, below which a special protection function is activated. When the superheat falls below the threshold, the system immediately enters low superheat status and activates a control action, in addition to normal control, with the aim of closing the electronic valve more quickly. In practice, the intensity of system "reaction" is increased. If the device remains in low superheat status for a certain period, a low superheat alarm is activated, with the display showing the message 'LSH'. The low superheat signal features automatic reset, when the condition is no longer present or the controller is switched off (standby). When low superheat is activated, any solenoid valves present can be forced closed (parameter P10).

Par.	Description	Def	Min	Max	UOM
P7	LowSH: low superheat threshold	7.0	-10.0	P3	K
P8	LowSH: integral time 0 = function disabled	15.0	0.0	240.0	s
P9	LowSH: alarm delay 0 = alarm disabled	600	0	999	s

Tab. 7.n

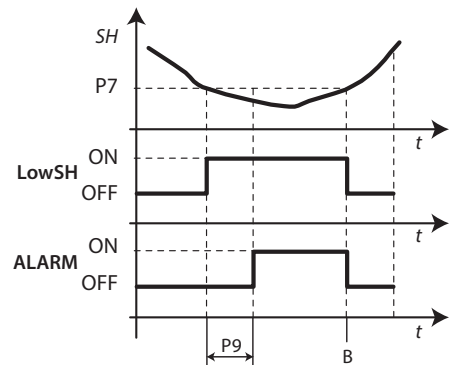

Fig. 7.d

Key

SH	Superheat	P7	Low SH protection threshold
LowSH	Low superheat protection	P9	Alarm delay
ALARM	Alarm	t	time

8. SIGNALS AND ALARMS





pRack Hecu can manage both alarms relating to the status of the digital inputs and to system operation. For each alarm, the following are controlled:

- Actions on the devices, if necessary
- Output relays (one global and two with different priorities, if configured)
- Red LED on the terminal and the buzzer, where featured
- Type of recognition (automatic, manual, semiautomatic)
- Any activation delay

The complete list of alarms, with the related information as described above, is available in the Alarm table.

8.1 Alarm management

All alarms feature the following behaviour:

- When an alarm is activated, the red LED flashes and the buzzer is activated (where featured); the relay corresponding to the global alarm and any alarms with high priority is activated (if configured)
- Pressing  (Alarm), the red LED stays on steady, the buzzer is muted and the alarm mask is shown
- If there is more than one active alarm, these can be scrolled using  (Up)  (Down). This situation is signalled by an arrow at the bottom right on the mask
- Pressing  (Alarm) again for at least 3 seconds manually acknowledges the alarms, which are cleared from the display unless others are active (they are saved in the log)

Priority



For certain alarms, the alarm output relays can be configured according to two types of priority:

- R1: serious alarm
- R2: normal alarm

The corresponding relays, once configured, are activated when an alarm with the corresponding priority occurs. For other alarms, priority is fixed and associated by default to one of the two relays.

Reset/acknowledgement



Alarms can be reset manually, automatically or semi-automatically:

- Manual: the alarm is acknowledged by pressing  (Alarm) twice, the first time displays the corresponding alarm mask and mutes the buzzer, the second (extended, for at least 3 seconds) cancels the alarm (which is saved in the log). If the alarm is still active, it is not reset and the signal is shown again.
- Automatic: when the alarm condition ceases, the alarm is automatically reset, the LED comes on steady and the corresponding mask remains displayed until  (Alarm) is pressed and held; the alarm is saved in the log.
- Semiautomatic: the alarm is reset automatically, until reaching a maximum number of activations in a set period. When the number reaches the maximum setting, the alarm then needs to be reset manually.

For manual reset, the functions associated with the alarm will not be reactivated until the alarm is reset, while for automatic reset, the functions are reactivated as soon as the alarm condition ceases.

Log

The alarm log can be accessed:

- from branch H.a of the main menu
- pressing  (Alarm) and then  (Enter) when there are no active alarms
- pressing  (Enter) after having scrolled all the alarms.

The alarm log masks show:

1. Order of activation (no. 01 is the oldest alarm)
2. Time and date the alarm was activated
3. Short description
4. Main values at the moment the alarm occurred (suction pressure and condensing pressure)



Note: a maximum of 50 alarms can be logged; after this limit any new events overwrite the oldest ones, which are therefore deleted.

8.2 Compressor alarms

The number of alarms can be chosen for each compressor, in the configuration phase (wizard) or subsequently in branch C.a.e of the main menu.

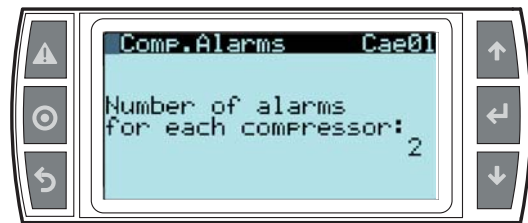

Fig. 8.e

After having selected the number of alarms (maximum 2), each alarm can be assigned a description, choosing from the options shown in the table, output relay, type of reset, delay and priority. The effect of the alarm on the devices is fixed and involves stopping the compressor, except for the oil warning.

Possible descriptions for compressor alarms

Reciprocating or scroll	
Generic	<input type="checkbox"/>
Overload	<input type="checkbox"/>
High pressure	<input type="checkbox"/>
Low pressure	<input type="checkbox"/>
Oil	<input type="checkbox"/>

Tab. 8.0

A possible mask for choosing the description of the alarm is shown in the figure:

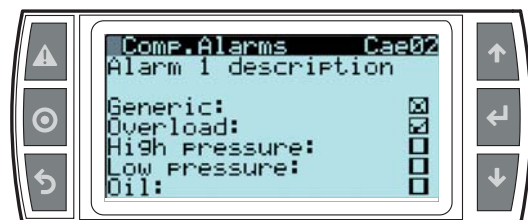

Fig. 8.f

After having selected the 'generic' description, no other description can be selected. In general, the descriptions are divided into four groups:

- generic
- others (overload, oil, high pressure, low pressure)

After having selected a description pertaining to one group, no descriptions from other groups can be selected for that alarm.

For example, the selection may be generic, or alternatively thermal overload + oil.

Each alarm will have its own unique alarm mask, and this will include all the descriptions associated with that alarm.

According to the number of alarms selected, the descriptions shown in the table will be associated by default.

Default descriptions based on the number of alarms

Number of alarms	Descriptions
1	Generic
2	Overload HP-LP
3	Overload HP-LP Oil
4	Overload HP LP Oil

Tab. 8.p

Note: in the event of oil alarms, a special function is available whereby the alarm is interpreted as an oil level warning. When the alarm is activated, the system tries to restore oil level for a set time, before signalling the alarm and stopping the compressor.

If a modulating device is used for the compressors, further alarms become available:

- compressor inverter warning, common for the entire suction line, when the device is an inverter
- oil crankcase temperature alarm, high discharge temperature.

8.3 Pressure alarms

pRack Hecu can manage pressure alarms from a pressure switch or probe, according to the following diagram.

Alarms from pressure switch:

- Low suction pressure
- High condensing pressure

Alarms from probe:

- Low suction pressure
- High suction pressure
- Low condensing pressure
- High condensing pressure

One possible example for the low pressure alarms is shown in the figure:

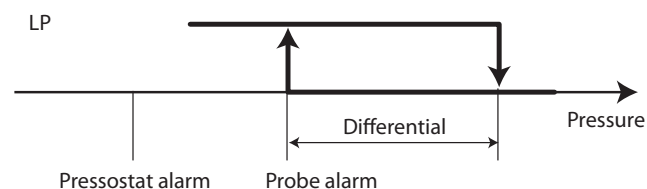

Fig. 8.g

Alarms from pressure switch

The parameters corresponding to these alarms can be set in branch G.c.a/G.c.b of the main menu.

Low suction pressure from pressure switch

The low suction pressure alarm from pressure switch has the effect of stopping all the compressors without observing the various times, therefore when the digital input configured as low pressure switch is activated, all the compressors on the line affected are stopped immediately.

This alarm features semiautomatic reset, and both the monitoring time and the number of activations in the specified period can be set. If the number of activations is higher, reset becomes manual.

In addition, the delay after which the alarm is activated on both start-up and during operation can be set.

The delay at start-up only applies to unit start-up and not compressor power-on.

High condensing pressure from pressure switch

The high condensing pressure alarm from pressure switch has the effect of stopping all the compressors without observing the various times and forcing the fans on at maximum speed, therefore when the digital input configured as high pressure switch is activated, all the compressors on the line affected are stopped immediately and the fans operate at maximum output.

This alarm features manual or automatic reset, as configured by the user. The delay after which the alarm is activated can also be set.

Pressure alarms from probe

The parameters corresponding to these alarms can be set in branch C.a.e of the main menu for suction pressure, and D.a.e for condensing pressure.

For these types of alarms, reset is automatic and the activation threshold and differential can be set, as well as the type of threshold, which may be absolute or relative to the control set point. The figure shows an example of setting the threshold to relative.

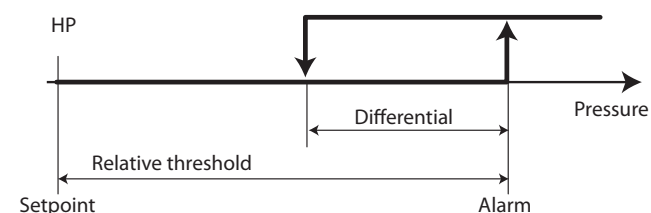

Fig. 8.h

Note: for temperature control, the alarms from probe are managed based on temperature even when pressure probes are fitted.

The effects of the different pressure alarms from probe are described below.

Low suction pressure from probe

The low suction pressure alarm from probe has the effect of stopping all the compressors without observing the times.

High suction pressure from probe

The high suction pressure alarm from probe has the effect of forcing all the compressors on, ignoring the control times, but observing the compressor protection times.

Low condensing pressure from probe

The low condensing pressure alarm from probe has the effect of stopping all the fans without observing the times.

High condensing pressure from probe

The high condensing pressure alarm from probe has the effect of forcing all the fans on and stopping all the compressors, ignoring the times.

8.4 Anti liquid return MPX valve alarm

In case of alarm that shutdown the compressor, if the function "anti liquid return MPX valve" is enable the evaporator valves will be forced close. This function is available in mask Cag65.

In case of low pressostat alarm the valves will not be forced close to allow the system to restart.

8.5 Alarm table

Alarm Code	Display description	Reset	Delay	Alarm relay	Action
ALU02	Regulation probe(s) missing	Automatic	Not present	Not present	Shutdown unit
ALA01	Discharge temperature probe broken or disconnected	Automatic	60 s	R2	Related functions disabled
ALA02	Condenser pressure probe broken or disconnected	Automatic	60 s	R1	Related functions disabled
ALA03	External temperature probe broken or disconnected	Automatic	60 s	R2	Related functions disabled
ALA24	Suction pressure probe broken or disconnected	Automatic	60 s	R1	Related functions disabled
ALA25	Suction temperature probe broken or disconnected	Automatic	60 s	R2	Related functions disabled
ALA26	Room temperature probe broken or disconnected	Automatic	60 s	R2	Related functions disabled
ALA31	Condenser pressure backup probe broken or disconnected	Automatic	60 s	R2	Related functions disabled
ALA33	Suction pressure backup probe broken or disconnected	Automatic	60 s	R2	Related functions disabled
ALA46	Vapor injection pressure probe broken or disconnected	Automatic	60 s	R1	Related functions disabled
ALA47	Vapor injection temperature probe broken or disconnected	Automatic	60 s	R1	Related functions disabled
ALB01	Low common suction pressure by pressostat Num.autom.reset: / in min	Semiautomatic	Config.	R1	Shutdown compressors
ALB02	High common condensing pressure by pressostat	Man./Autom.	Config.	R1	Shutdown compressors
ALB03	Low condenser pressure alarm	Automatic	Settable	R1	Fan forcing at 0%
ALB04	High condenser pressure alarm	Automatic	Settable	R1	Fan forcing at 100% (5 min.) and shutdown compressor
ALB07	Fans common overload	Automatic	Config.	Config.	-
ALB15	High suction pressure alarm	Automatic	Config.	R1	-
ALB16	Low suction pressure alarm	Automatic	Config.	R1	-
ALB22	Oil sensor level broken or disconnected	Manual	Config.	R1	Shutdown compressor
ALC01	Alarm 1 compressor 1:	Man./Autom.	Config.	Config.	Shutdown compressor
ALC02	Alarm 2 compressor 1:	Man./Autom.	Config.	Config.	Shutdown compressor
ALC05	Alarm comp. backup	Man./Autom.	Config.	Config.	Shutdown compressor
ALG01	Clock board error	Automatic	-	R2	Related functions disabled
ALG02	Extended memory error	Automatic	-	R2	Related functions disabled
ALT01	Compressors working hours	Manual	-	Not present	-
ALT15	Low superheat alarm	Settable	Settable	R1	Shutdown compressors
ALT19	DSH Low Liquid flowback	Settable	Settable	R1	Shutdown compressors
ALW05	Warning Fans inverter	Automatic	Not present	Not present	-
ALW10	Warning Low superheat	Automatic	Not present	Not present	-
ALW16	Warning Invalid activation of oil level inputs, check the connections	Automatic	-	R2	-
ALW15	Warning An error occurred during auto-configur.	Automatic	Not present	Not present	-
ALW24	Power+ n° Device Offline	Semiautomatic	2 s	R1	Shutdown compressors
ALW25	Power+ n°	Semiautomatic	Not present	R1	Shutdown compressors
ALW26	Compressor start failure (tempt.: / max.:)	Semiautomatic	Not present	R1	-
ALW27	Envelope alarm Zone:	Semiautomatic	Not present	R1	Shutdown compressors
ALW28	High discharge gas temperature	Automatic	10 s	R1	-
ALW29	Low pressure differential (insuff. lubrication)	Automatic	Settable	R1	-
ALW30	Inverter model not compatible (Power+ only allowed)	Automatic	Not present	R1	-
ALW38	Low oil level fault	Manual	Settable	R1	Shutdown compressors
ALW39	High oil level fault	Manual	Settable	R1	Shutdown compressors
ALA04	General function probe A in board 1 broken or disconnected	Automatic	60 s	R2	Related functions disabled
ALA05	General function probe B in board 1 broken or disconnected	Automatic	60 s	R2	Related functions disabled
ALA06	General function probe C in board 1 broken or disconnected	Automatic	60 s	R2	Related functions disabled
ALA07	General function probe D in board 1 broken or disconnected	Automatic	60 s	R2	Related functions disabled
ALA08	General function probe E in board 1 broken or disconnected	Automatic	60 s	R2	Related functions disabled
ALG11	High thermostat alarms Function:1-5	Man./Autom.	Config.	Config.	-
ALG15	Low thermostat alarms Function:1-5	Man./Autom.	Config.	Config.	-
ALG19	High modulating alarms Function:6-7	Man./Autom.	Config.	Config.	-
ALG23	Low modulating alarms Function:6-7	Man./Autom.	Config.	Config.	-
ALG27	Generic normal alarms Function:8-9	Man./Autom.	Config.	Config.	-
ALG28	Generic serious alarms Function:8-9	Man./Autom.	Config.	Config.	-
ALW40-53-66-79-92	Store number: !! OFFLINE !!	-	Not present	R2	2
ALW41-54-67-80-93	Store number: Low temperature alarm [Generic Probe 1]	Display only (refer to +0300055IT MPXPRO manual)			
ALW42-55-68-81-94	Store number: High temperature alarm [Generic Probe 1]	Display only (refer to +0300055IT MPXPRO manual)			
ALW43-56-69-82-95	Store number: Low temperature alarm [Generic Probe 2]	Display only (refer to +0300055IT MPXPRO manual)			
ALW44-57-70-83-96	Store number: High temperature alarm [Generic Probe 2]	Display only (refer to +0300055IT MPXPRO manual)			
ALW45-58-71-84-97	Store number: Defrost timeout	Display only (refer to +0300055IT MPXPRO manual)			
ALW46-59-72-85-98	Store number: Low superheat alarm	Display only (refer to +0300055IT MPXPRO manual)			
ALW47-60-73-86-99	Store number: Low suction temp.alarm	Display only (refer to +0300055IT MPXPRO manual)			
ALW48-61-74-87-ALZ00	Store number: MOP alarm	Display only (refer to +0300055IT MPXPRO manual)			
ALW49-62-75-88-ALZ01	Store number: LOP alarm	Display only (refer to +0300055IT MPXPRO manual)			
ALW50-63-76-89-ALZ02	Store number: Stepper driver communication error	Display only (refer to +0300055IT MPXPRO manual)			
ALW51-64-77-90-ALZ03	Store number: Stepper motor error	Display only (refer to +0300055IT MPXPRO manual)			
ALW52-65-78-91-ALZ04	Store number: Installation or config problems on EEV driver	Display only (refer to +0300055IT MPXPRO manual)			

9. SOFTWARE UPDATE

9.1 Uploading/updating the software (Upload)

The following methods can be used to update the firmware and acquire the log files on pCO controllers:

- SmartKey programming key;
- pCO manager tool, installable on a PC.

Smart key

The PCOS00AKY0 key is an electronic device used to program and service the pCO sistema family controllers. PCOS00AKY0 simplifies data transfer between the controllers installed and a personal computer by exploiting the high capacity flash memory for storing software applications, BIOS and variable logs. The pCO is connected directly via the telephone connector using the cable supplied, while to transfer the data to a personal computer, the USB adapter code PCOS00AKC0 is required. The power supply comes either via the USB port on the PC or from the controller, therefore no external power supply is needed.

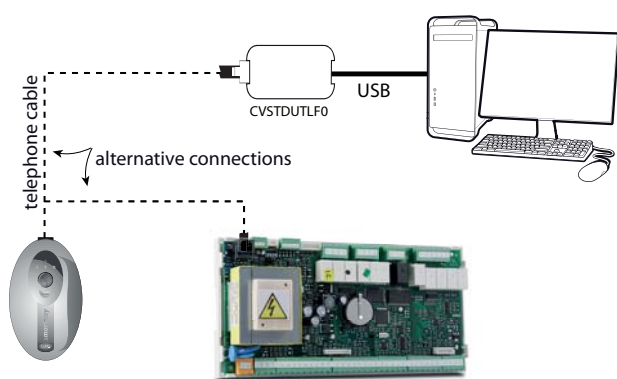

Fig. 9.a

Operating instructions

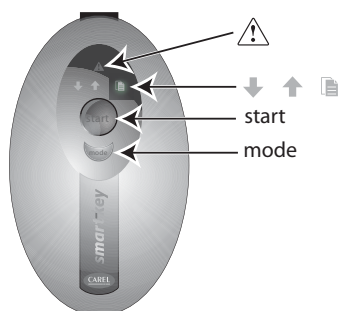

Fig. 9.b

Programming the Smart Key via Personal Computer

The operating modes described in the table below can be configured using a program on the PC. The program can also load the software to the key or transfer logged data from the controller to disk.

Type	Function	Mode button
B	Update software from key to pCO (BIOS, application, parameters, etc.)	Disabled
C*	Copy software from pCO to pCO (BIOS, application, parameters, etc.)	Switches the key from write mode to read mode
D	Read logs	Disabled
E	Read logged data and software from pCO (BIOS, application, parameters, etc.)	Disabled
F	Read logged data	Disabled
G	Copy from pCO to pCO and read logs	Switches the key to write mode, read mode and read logs mode

*: Default mode

Tab. 9.a

The key is factory-programmed in read/write mode (type C) so that it can be used immediately to transfer software from one controller to another. When the key is connected to the personal computer, the symbols have the following meanings:

↑ ↓	Flashing	Waiting for connection to PC
↑ ↓	Alternating	When connected to PC indicates data transfer in progress

The programming key is compatible starting from BIOS version 3.43 and BOOT version 3.01. For more detailed information on programming the key, see the pCO Manager program manual.

Using the Smart Key with the pCO/μPC

Switch off the pCO, remove any peripherals connected in the pLAN and plug the key into the telephone connector on the controller. When switching on again, all the symbols light up momentarily and the buzzer emits a beep. A few seconds later the key becomes operational. During this period the symbols ↑ ↓ will flash. The controller then enters programming mode and the start button lights up steadily. Press the button to start data transfer.

⚠ Important:

- If the key is type B, C or G (in write mode) pressing the start button will immediately delete the software already loaded on the pCO.
- Do not remove the key while data is being transferred to the key itself, as the file being transferred will be lost and the corresponding space will not be restored. To restore the original capacity all the files will need to be deleted. If the key is type "C" or "G", simply perform a new application read operation.

Meanings of Buttons/Symbols

↑ ↓	Flashing; the key is connecting to the pCO. During this phase, which may last a few seconds, the start button is disabled.
start	Flashing; The key has detected the pCO and is checking the access rights.
start+ ↑	On steady; Pressing the start button will start writing the software to the pCO.
start+ ↓	On steady; Pressing the start button will start reading the software from the pCO.
start+ 📄	On steady; Pressing the start button will start reading the logs from the pCO.
mode	On steady; In case of C or G keys, pressing the button for 1 second switches from read to write.

Tab. 9.a

If the key is type C of G, pressing the "mode" button for 1 second switches from read to read logs (G only) or to write. The symbols ↑ (write to pCO), ↓ (read from pCO), 📄 (read logs) reflect the selected status. If the key is not type "C" or "G", the "mode" button is disabled and off. The "start" button starts the read or write operation, indicated by the flashing of the corresponding symbol (↑ or ↓) at a frequency proportional to the progress of the operation. When the operation is completed, the buzzer will sound intermittently for 2 seconds. Pressing the start button again will make the buzzer sound without repeating the operation. To repeat the operation, the key must first be unplugged. In case of error the symbol will light up together with the other LEDs. The following table can help you find the cause of the problem.

Errors before pressing the START button

	Symbols flashing	Communication error: No response from the pCO or: Key firmware version is incompatible.
	Symbols steady	Password error
	Symbols flashing	Type of key is incompatible
	Symbols steady	The key is missing one or more required files (memory empty; no kit for the type of pCO connected)
	Symbols steady + flashing start	Incompatibility between the software on the key and the pCO HW
	Symbols steady + flashing mode	Incompatibility between pCO application and HW (application size)
	Symbols steady	No logged data present on the pCO
	Steady	Type of key not programmed.

Tab. 9.b

Errors after pressing the START button

	Symbols flashing and buzzer sounding intermittently	Write operation failed
	Symbols flashing and buzzer sounding intermittently	Read operation failed
	Symbols flashing and buzzer sounding intermittently	Read logs operation failed
	Symbols steady + flashing	Incompatibility between log configuration and pCOHW (no flash memory). This error does not prevent writing other files.
	Steady	Insufficient space to read logs
	Flashing	Generic error

Tab. 9.c

pCOmanager: operating instructions

pCO Manager is a program that lets you manage all the configuration, debugging and maintenance operations on pCO System devices. pCO Manager can be installed by itself or as part of the 1Tool programming environment.

Installing pCO Manager

Go to <http://ksa.carel.com> and, in section pCO System, select pCO_manager. After you accept the general conditions of the software's free use licence, a window will open from which you can download the file pCO_manager.zip. Install the program on your computer.

Connecting the PC to the pCO controller

Connect a cable with USB/RS485 converter to the USB port on the computer, and connect the converter to a telephone cable plugged into the pLAN port of the pCO.

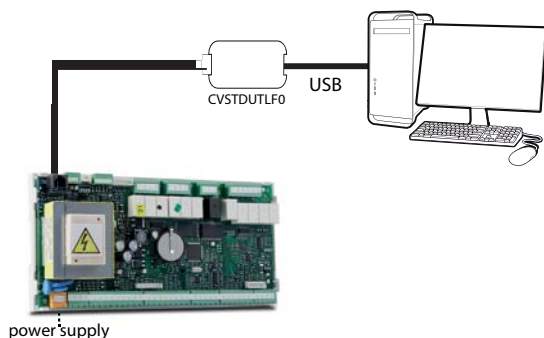

Fig. 9.c

Upon launching, pCO Manager will display a mask showing the connection settings in the upper right-hand corner. Choose:

1. "connessione locale" [local connection];
2. baud rate: Auto;
3. "ricerca dispositivo" [find device]: Auto (pLAN).

As for the port number, follow the Wizard's instructions for the port to be identified automatically (e.g. COM4).



Fig. 9.d

Switch the controller off and then on again and use the Connect command to establish the connection. When the connection is established the flashing message "ONLINE" will appear at the bottom left of the mask.



Fig. 9.e

Installing the application program

- Select the directory containing the application program files and click "Upload" to upload the program to the pCO controller.

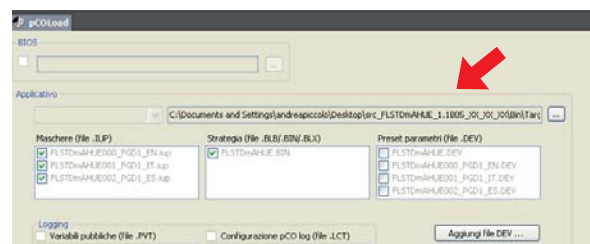

Fig. 9.f

Commissioning

- Using the mouse, select "Commissioning" at the bottom left. A new work environment will appear.

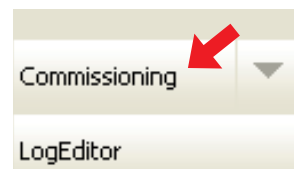

Fig. 9.g

- Click on "configura dispositivo" [configure device] to display all the application variables. The variables can be selected according to the categories that appear at the bottom.



Fig. 9.h

Changing a parameter

Select the parameter category and then the parameter that you want to edit. The parameter (e.g. recovery.recovery_type) will be highlighted in blue.

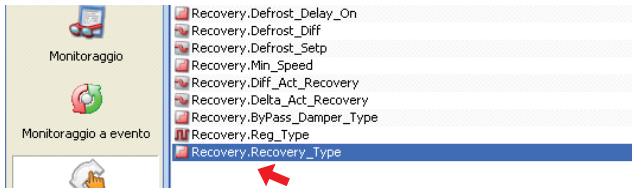

Fig. 9.i

1. Double-click on the column marked "letto" [read]. A window will appear in which you can enter the new value for the parameter.

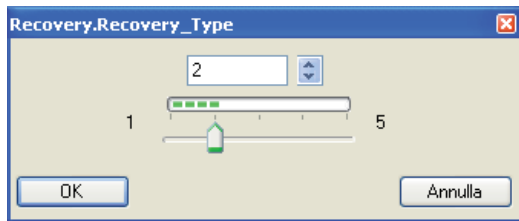

Fig. 9.j

2. Enter the new value (e.g. 3) and click OK. The new value will appear in the column marked "scritto" [written]. To write the parameter to the pCO controller, right-click and select "scrivi selezionate" [write selected]. The new value will appear in the column marked "scritto" [written], meaning that the parameter has been written to the controller.

Default	Letto		Scritto
120	120	✓	120
1	1	✓	1
5,0	5,0	✓	5,0
60	60	✓	60
3,0	3,0	✓	3,0
0	0	✓	0
100	100	✓	100
120	120	✓	120
4,0	4,0	✓	4,0
-1,0	-1,0	✓	-1,0
20	20	✓	20
0,3	0,3	✓	0,3
0,5	0,5	✓	0,5
1	1	✓	1
0	0	✓	0
1	3	✓	3



Fig. 9.k

Click on "Salva" [Save] to generate the project's ".2cw" file.

Commissioning: basic concepts

Note: The following paragraphs are from the online help of pCO Manager, to which the user is referred for further details.

Commissioning is a configuring and real-time monitoring software that can be used to supervise the performance of an application program installed on a pCO, to start up the pCO and to perform debugging and maintenance. With this software the user can set the configuration parameters, edit the values of volatile and permanent variables, save on file the trends of the unit's main quantities, manually manage the unit's I/O using simulation files and monitor/reset the alarms of the unit on which the device is installed.

Work carried out with Commissioning is preceded by configuring the work environment, which is typically done by the project designer. The active project in 1Tool is automatically loaded by pCO Manager.

The project designer can use the configuration functions of Commissioning to decide which variables should be subjected to monitoring, logging, trend-monitoring and event-monitoring, to organize variables into categories and to create sets of configuration parameters.

Operators using Commissioning for maintenance will be able to see the necessary variables and to draw from preset configuration values.

Support files

Once the design of the application is completed, 1Tool generates a number of files in the compiling stage, two of which are required by Commissioning:

- <applicationName>.2CF (variable descriptor)
- <applicationName>.2CD (category and access profile descriptor)

In addition to these files, the software also manages the applicationName.DEV file, which contains the unit's preset parameters. When the user has finished using Commissioning, whether for configuration or monitoring purposes, the following files can be generated:

- <applicationName>.2CW (descriptor for categories, access profiles, monitoring groups);
- <FilenameCommissioningLog>.CSV (file used for the commissioning log, containing data of the variables logged during monitoring).

Therefore, to configure Commissioning the following files are required: .2CF, 2CD and, if necessary, the .DEV file, which can be imported or exported. For monitoring purposes, in addition to the files above, it might also be necessary to have the .2CW file, containing the definition of the work environment. The commissioning log file is a simple output file.

pCO Load: basic concepts

pRackLoad is the module that manages:

- uploading to the flash memory (of the device or of the ProgKeyX key installed on the pRack);
- uploading to the NAND memory of certain devices;
- downloading the log file, .DEV file and P memory (from the flash memory);
- downloading files from the NAND memory, if present.

The files exchanged with the Flash memories of pRack controllers are:

- Boot.BIN (download riservato, upload abilitato da menu);
- Bios.BIN (download riservato);
- <applicationName>.BLB (download riservato);
- <applicationName>.BIN (download riservato);
- <applicationName>.DEV;
- <applicationName>.GRT (upload only, where the .GRP file is extracted);
- <applicationName>.IUP;
- <applicationName>.LCT;
- <applicationName>.PVT;
- <pCOlogName>.BIN, <pCOlogName>.CSV, <pCOlogName>.CSV (only if log files have been configured, download only).

The files exchanged with the NAND memories of pRack controllers are:

- any file that the pRack can independently copy to the flash memory (see above list);
- external files (e.g. .pdf or .doc files for documentation).

LogEditor: basic concepts

LogEditor is the module used to configure the log files of pCO devices (pCO logs). Configuring pCO logs consists in defining a number of sets of variables in which to specify which variables should be logged, the logging method (by frequency or by event) and the minimum number of loggings required. Configuration is based on a binary file (.PVT – Public Variable Table), which is generated by 1Tool and contains the descriptive data of the variables that can be logged.

All the log configurations so defined are saved in the .LCT (Log Configuration Table) binary file, which must be uploaded to the pCO together with the .PVT file. Log configuration data is also saved in a file that can be used only by LogEditor – the .LEF file, which must be saved to be edited with LogEditor as necessary.

LogEditor can be used even when the device is not connected. Once the files for logging are uploaded to the pCO, the pCO saves the logged data in the following files:

- .BIN file containing all the data in binary format;
- .CSV file containing the same data in a generic format with values separated by commas;
- *_GRAPH.CSV containing the same data to be used for charting purposes.

CAREL

CAREL INDUSTRIES - Headquarters
Via dell'Industria, 11 - 35020 Brugine - Padova (Italy)
Tel. (+39) 049.9716611 - Fax (+39) 049.9716600
e-mail: carel@carel.com - www.carel.com

Agenzia / Agency: