

# WQL-WQH-WQRC



English

Français

Deutsch

Italiano

Español



21  
↓  
193 kW



24  
↓  
211 kW



**Water Cooled Liquid Chillers - Water/Water Reverse Cycle Heat Pumps - Condenserless Units**  
**Refroidisseurs de Liquid à Condensation par l'Eau - Pompes à Chaleur Réversibles Eau/Eau**  
**Refroidisseurs de Liquid sans Condenseur**

**Flüssigkeitskühler Wassergekühlt - Wasser/Wasser Wärmepumpen - Werdampfeinheiten**  
**(ohn Verflüssiger)**

**Refrigeratori di Liquido Condensati ad Acqua - Pompe di Calore Acqua/Acqua - Unità Motoevaporanti**  
**Enfriadoras de Fluido con Condensación por Agua - Bomba de Calor Agua/Agua**  
**Modelo Condensador Remoto**

Part number / Code / Code / Codice / Código: **358591/A**

Supersedes / Annule et remplace / Annulliert und ersetzt / Annulla e sostituisce /  
Anula y sustituye: **035B09063-000**

Notified Body / Organisme Notifié / Benannte Zertifizierungsstelle / Organismo  
Notificato / Organismo Notificado N°. 1115 **PASCAL**™





# Table of Contents

## 1 - FOREWORD

|   |   |
|---|---|
| 1.1 Introduction.....                   | 2 |
| 1.2 Warranty.....                       | 2 |
| 1.3 Emergency stop/Normal stop.....     | 2 |
| 1.4 An introduction to this manual..... | 2 |

## 2 - SAFETY

|  |         |
|--|---------|
| 2.1 Foreword.....                                  | 3       |
| 2.2 Definitions.....                               | 4       |
| 2.3 Access to the unit.....                        | 4       |
| 2.4 General precautions.....                       | 4       |
| 2.5 Precautions against residual risks.....        | 4       |
| 2.6 Precautions during maintenance operations..... | 5       |
| 2.7 Safety labels.....                             | 6 to 8  |
| 2.8 Safety regulations.....                        | 9 to 11 |

## 3 - TRANSPORT, LIFTING AND POSITIONING

|                     |    |
|---------------------|----|
| 3.1 Inspection..... | 12 |
| 3.2 Handling.....   | 12 |
| 3.3 Anchoring.....  | 13 |
| 3.4 Storage.....    | 13 |

## 4 - INSTALLATION

|  |          |
|--|----------|
| 4.1 Positioning of the unit.....         | 14       |
| 4.2 Spring Isolator Installation.....    | 14       |
| 4.3 Internal/external Water Circuit..... | 15 to 18 |
| 4.4 Water connections.....               | 19       |
| 4.5 Power supply.....                    | 19       |
| 4.7 Electrical connections.....          | 20 & 21  |

## 5 - START-UP

|                                   |    |
|-----------------------------------|----|
| 5.1 Preliminary check.....        | 22 |
| 5.2 Start-up.....                 | 22 |
| 5.3 Checking the operation.....   | 22 |
| 5.4 Delivery to the customer..... | 22 |

## 6 - CONTROL

|   |    |
|---|----|
| 6.1 Control of WQL/WQH/WQRC units,<br>single/double compressor..... | 23 |
| 6.2 Keypad functions.....   | 23 |
| 6.3 Folder structure.....   | 24 |
| 6.4 Menu structure.....   | 24 |
| 6.5 Alarm list.....   | 25 |

## 7 - PRODUCT DESCRIPTION

|                                      |    |
|--------------------------------------|----|
| 7.1 General Information.....         | 26 |
| 7.2 Body and Frame.....              | 26 |
| 7.3 Compressors.....                 | 26 |
| 7.4 Refrigeration circuits.....      | 26 |
| 7.5 Evaporator.....                  | 26 |
| 7.6 Condenser (except for WQRC)..... | 26 |
| 7.7 Switch board.....                | 26 |
| 7.8 Accessories.....                 | 28 |

## 8 - TECHNICAL DATA

|   |          |
|---|----------|
| 8.1 Pressure drops.....   | 30       |
| 8.2 Technical data.....   | 31 to 33 |
| 8.3 Unit electrical data.....   | 34       |
| 8.4 Hydraulic Features.....   | 35 to 36 |
| 8.5 Position of shock adsorbers<br>and weight distribution on supports..... | 37 & 39  |
| 8.6 Dimensional Drawings.....   | 40 & 45  |
| 8.7 unit clearances.....  | 46       |

## 9 - MAINTENANCE

|                                     |    |
|-------------------------------------|----|
| 9.1 General requirements.....       | 47 |
| 9.2 Planned maintenance.....        | 47 |
| 9.3 Refrigerant charge.....         | 48 |
| 9.4 Compressor.....                 | 48 |
| 9.5 Condenser.....                  | 48 |
| 9.6 Dehydrating filter.....         | 48 |
| 9.7 Sight glass.....                | 48 |
| 9.8 Mechanical expansion valve..... | 49 |
| 9.9 Evaporator.....                 | 49 |

## 10 - TROUBLESHOOTING

## 11 - SPARE PARTS

|                               |    |
|-------------------------------|----|
| 11.1 Spare part list.....     | 51 |
| 11.2 Oil for compressors..... | 51 |
| 11.3 Wiring diagrams.....     | 51 |

## 12 - DISMANTLING, DEMOLITION AND SCRAPPING

|                        |    |
|------------------------|----|
| 12.1 Generalities..... | 52 |
|------------------------|----|

# 1 - Foreword

## 1.1 Introduction

Units, manufactured to state-of-the-art design and implementation standards, ensure top performance, reliability and fitness to any type of air-conditioning systems.

These units are designed for cooling water or glycoled water (and for water heating in heat pump models) and are unfit for any purposes other than those specified in this manual.

This manual includes all the information required for a proper installation of the units, as well as the relevant operating and maintenance instructions.

It is therefore recommended to read this manual carefully before installation or any operation on the machine. The chiller installation and maintenance must be carried out by skilled personnel only (where possible, by one of Authorised Service Centers).

The manufacturer may not be held liable for any damage to people or property caused by improper installation, start-up and/or improper use of the unit and/or failure to implement the procedures and instructions included in this manual.

## 1.2 Warranty

These units are delivered complete, tested and ready for being operated. Any form of warranty will become null and void in the event that the appliance is modified without manufacturer's preliminary written authorisation.

This warranty shall apply providing that the installation instructions have been complied with (either issued by manufacturer, or deriving from the current practice), and the Form 1 ("Start-up") has been filled-in and mailed to manufacturer (attn. After-Sales Service).

In order for this warranty to be valid, the following conditions shall be met:

- The machine must be operated only by skilled personnel from Authorised After-Sales Service.
- Maintenance must be performed only by skilled personnel - from one of Authorised After-Sales Centers.
- Use only original spare parts.
- Carry out all the planned maintenance provided for by this manual in a timely and proper way.

Failure to comply with any of these conditions will automatically void the warranty.

## 1.3 Emergency stop / Normal stop

The emergency stop of the unit can be enabled using the master switch on the control panel (move down the lever).





For a normal stop, press the relevant push-buttons.

To restart the appliance, follow the procedure detailed in this manual.

## 1.4 An introduction to the manual

For safety reasons, it is imperative to follow the instructions given in this manual. In case of any damage caused by non-compliance with these instructions, the warranty will immediately become null and void.

Conventions used throughout the manual:

|   |  |
|---|--|
|    | The Danger sign recalls your attention to a certain procedure or practice which, if not followed, may result in serious damage to people and property. |
|   | The Warning sign precedes those procedures that, if not followed, may result in serious damage to the appliance.                                       |
|  | The Notes contain important observations.  |
|  | The Useful Tips provide valuable information that optimises the efficiency of the appliance.   |

This manual and its contents, as well as the documentation which accompanies the unit, are and remain the property of manufacturer, which reserves any and all rights thereon. This manual may not be copied, in whole or in part, without manufacturer's written authorization.

### 2.1 Foreword

These units must be installed in conformity with the provisions of Machinery Directive 2006/42/EC, Low Voltage Directive 2006/95/EC, Pressure Vessels Directive 97/23/EC, Electromagnetic Interference Directive 2004/108/EC, as well as with other regulations applicable in the country of installation. If these provisions are not complied with, the unit must not be operated.

|   |  |
|---|--|
|  | <p>The unit must be grounded, and no installation and/or maintenance operations may be carried out before deenergising the electrical panel of the unit.</p> |
|---|--|

Failure to respect the safety measures mentioned above may result in electrocution hazard and fire in the presence of any short-circuits.

|  |  |
|--|--|
|  | <p>Inside the heat exchangers, the compressors and the refrigeration lines, this unit contains liquid and gaseous refrigerant under pressure. The release of this refrigerant may be dangerous and cause injuries.</p> |
|--|--|

|   |   |
|---|---|
|  | <p>The units are not designed to be operated with natural refrigerants, such as hydrocarbons. Manufacturer may not be held liable for any problems deriving from the replacement of original refrigerant or the introduction of hydrocarbons.</p> |
|---|---|

Units are designed and manufactured according to the requirements of European Standard PED 97/23/EC (pressure vessels).

- The used refrigerants are included in group II (non-hazardous fluids).
- The maximum working pressure values are mentioned on the unit's data plate.
- Suitable safety devices (pressure switches and safety valves) have been provided, to prevent any anomalous overpressure inside the plant.
- The vents of the safety valves are positioned and oriented in such a way as to reduce the risk of contact with the operator, in the event that the valve is operated. Anyway, the installer will convey the discharge of the valves far from the unit.
- Dedicated guards (removable panels with tools) and danger signs indicate the presence of hot pipes or components (high surface temperature).

|   |   |
|---|---|
|  | <p>It is the User's responsibility to ensure that the unit is fit for the conditions of intended use and that both installation and maintenance are carried out by experienced personnel, capable of respecting all the recommendations provided by this manual.</p> <p>It is important that the unit is adequately supported, as detailed in this manual. Non-compliance with these recommendations may create hazardous situations for the personnel.</p> |
|---|---|

|   |   |
|---|---|
|  | <p>The unit must rest on a base which meets the characteristics specified in this manual; a base with inadequate characteristics is likely to become a source of serious injury to the personnel.</p> |
|---|---|

|  |  |
|--|--|
|  | <p>The unit has not been design to withstand loads and/or stress that may be transmitted by adjacent units, piping and/or structures.</p> <p>Each external load or stress transmitted to the unit may break or cause breakdowns in the unit's structure, as well as serious dangers to people. In these cases, any form of warranty will automatically become null and void.</p> |
|--|--|

|   |  |
|---|--|
|  | <p>The packaging material must not be disposed of in the surrounding environment or burnt.</p> |
|---|--|

## 2 - Safety (continued)

### 2.2 Definitions

**OWNER:** means the legal representative of the company, body or individual who owns the plant where unit has been installed; he/she has the responsibility of making sure that all the safety regulations specified in this manual are complied with, along with the national laws in force.

**INSTALLER:** means the legal representative of the company who has been given by the owner the job of positioning and performing the hydraulic, electric and other connections of unit to the plant: he/she is responsible for handling and properly installing the appliance, as specified in this manual and according to the national regulations in force.

**OPERATOR:** means a person authorised by the owner to do on unit all the regulation and control operations expressly described in this manual, that must be strictly complied with, without exceeding the scope of the tasks entrusted to him.

**ENGINEER:** means a person authorised directly by manufacturer or, in all EC countries, excluding Italy, under his full responsibility, by the distributor of product, to perform any routine and extraordinary maintenance operations, as well as any regulation, control, servicing operations and the replacement of pieces, as may be necessary during the life of the unit.

### 2.3 Access to the unit

The unit must be placed in an area which can be accessed also by OPERATORS and ENGINEERS; otherwise the unit must be surrounded by a fence at not less than 2 meters from the external surface of the machine.

OPERATORS and ENGINEERS must enter the fenced area only after wearing suitable clothing (safety shoes, gloves, helmet etc.). The INSTALLER personnel or any other visitor must always be accompanied by an OPERATOR.

For no reason shall any unauthorised personnel be left alone in contact with the unit.

### 2.4 General precautions

The OPERATOR must simply use the controls of the unit; he must not open any panel, other than the one providing access to the control module.

The INSTALLER must simply work on the connections between plant and machine; he must not open any panels of the machine and he must not enable any control.

When you approach or work on the unit, follow the precautions listed below:

- do not wear loose clothing or jewellery or any other accessory that may be caught in moving parts
- wear suitable personal protective equipment (gloves, goggles etc.) when you have to work in the presence of free flames (welding operations) or with compressed air
- if the unit is placed in a closed room, wear ear protection devices
- cut off connecting pipes, drain them in order to balance the pressure to the atmospheric value before disconnecting them,

disassemble connections, filters, joints or other line items

- do not use your hands to check for any pressure drops
- use tools in a good state of repair; be sure to have understood the instructions before using them
- be sure to have removed all tools, electrical cables and any other objects before closing and starting the unit again

### 2.5 Precautions against residual risks

#### Prevention of residual risks caused by the control system

- be sure to have perfectly understood the operating instructions before carrying out any operation on the control panel
- when you have to work on the control panel, keep always the operating instructions within reach
- start the unit only after you have checked its perfect connection to the plant
- promptly inform the ENGINEER about any alarm involving the unit
- do not reset manual restoration alarms unless you have identified and removed their cause

#### Prevention of residual mechanical risks

- install the unit according to the instructions provided in this manual
- carry out all the periodical maintenance operations prescribed by this manual
- wear a protective helmet before accessing the interior of the unit
- before opening any panelling of the machine, make sure that it is secured to it by hinges
- do not remove the guards from moving elements while the unit is running
- check the correct position of the moving elements' guards before restarting the unit

#### Prevention of residual electrical risks

- connect the unit to the mains according to the instructions provided in this manual
- periodically carry out all the maintenance operations specified by this manual
- disconnect the unit from the mains by the external disconnecting switch before opening the electrical board
- check the proper grounding of the unit before start-up
- check all the electrical connections, the connecting cables, and in particular the insulation; replace worn or damaged cables
- periodically check the board's internal wiring
- do not use cables having an inadequate section or flying

## 2 - Safety (continued)

connections, even for limited periods of time or in an emergency

### Prevention of other residual risks

- make sure that the connections to the unit conform to the instructions provided in this manual and on the unit's panelling
- if you have to disassemble a piece, make sure that it has been properly mounted again before restarting the unit
- do not touch the delivery pipes from the compressor, the compressor and any other piping or component inside the machine before wearing protective gloves
- keep a fire extinguisher for electrical appliances near the machine
- on the units installed indoor, connect the safety valve of the refrigeration circuit to a piping network that can channel any overflowing refrigerant outside
- remove and leak of fluid inside and outside the unit
- collect the waste liquids and dry any oil spillage
- periodically clean the compressor compartment, to remove any fouling
- do not store flammable liquids near the unit
- do not disperse the refrigerant and the lubricating oil into the environment
- weld only empty pipes; do not approach flames or other sources of heat to refrigerant pipes
- do not bend/hit pipes containing fluids under pressure

### 2.6 Precautions during maintenance operations

Maintenance operations can be carried out by authorised technicians only.

Before performing any maintenance operations:

- disconnect the unit from the mains with the external disconnecting switch

- place a warning sign "do not turn on - maintenance in progress" on the external disconnecting switch
- make sure that on-off remote controls are inhibited
- wear suitable personal protective equipment (helmet, safety gloves, goggles and shoes etc.)

To carry out any measurements or checks which require the activation of the machine :

- work with the electrical board open only for the necessary time
- close the electrical board as soon as the measurement or check has been completed
- for outdoor units, do not carry out any operations in the presence of dangerous climatic conditions (rain, snow, mist etc.)



The following precautions must be always adopted:

- do not scatter the fluids of the refrigeration circuit in the surrounding environment
- when replacing an eprom or electronic cards, use always suitable devices (extractor, antistatic bracelet, etc.)
- to replace a compressor, the evaporator, or any other weighty element, make sure that the lifting equipment is consistent with the weight to be lifted
- contact manufacturer for any modifications to the refrigeration, hydraulic or wiring diagram of the unit, as well as to its control logics
- contact manufacturer if it is necessary to perform very difficult disassembly and assembly operations
- use only original spare parts purchased directly from manufacturer or the official retailers of the companies on the recommended spare parts list
- contact manufacturer if it is necessary to handle the unit one year after its positioning on site or if you wish to dismantle it.

## 2 - Safety (continued)

### 2.7 Safety labels

#### Identification of the unit Outside, on the left -hand front column

|   |                     |
|---|---------------------|
| COD. PRODOTTO NEUTRO<br>PRODUCT CODE  | ( B )               |
| MODELLO<br>MODEL  | ( A )               |
|  ( C )  |                     |
| MATRICOLA<br>SERIAL NUMBER  | ( NOTA )            |
| ANNO DI COSTRUZIONE   |                     |
| CARICA REFR. x CIRCUIT (1/2/3/4)<br>REFRIGERANT CHARGE  | Kg ( D )            |
| PS (LATO ALTA / LATO BASSA)<br>PS (HIGH/LOW SIDE)   | bar ( M ) ( N )     |
| TS (ALTA / BASSA)<br>TS (HIGH/LOW)  | °C ( Q ) ( R )      |
| ALIM. POTENZA<br>MAIN SUPPLY  | V/PHz ( P ) ( S )   |
| CORRENTE DI SPUNTO<br>ISA   | (max) A ( G )       |
| CORRENTE A PIENO CARICO<br>FLA  | (max) A ( H )       |
| POTENZA ASSORBITA<br>POWER INPUT  | (max) kW ( I )      |
| PRESS. MAX ESERCIZIO ACQUA<br>MAX WATER OPERATING PRESSURE  | bar 10              |
| MASSA<br>MASS   | Kg ( L )            |
| SYSTEMAR AC S.r.l. Via 10V Aprile 29 20822 BARLASSINA MI (ITALIA)<br>MADE IN ITALY COD.00800483-000 F   |                     |
| MODELLO:<br>MATRICOLA:<br>CODICE:   | ANNO DI COSTRUZIONE |
| MODELLO:<br>MATRICOLA:<br>CODICE:   | ANNO DI COSTRUZIONE |
| MODELLO:<br>MATRICOLA:<br>CODICE:   | ANNO DI COSTRUZIONE |

#### Pump operation - Outside, on the right-hand front column

**LAS BOMBAS MONTADAS EN ESTA UNIDAD NO PUEDEN TRABAJAR SIN AGUA.  
DIE PUMPEN DIESES GERÄTES DÜRFEN NICHT OHNE WASSER BETRIEBEN WERDEN.  
THE PUMPS ON BOARD OF THIS UNIT CAN NOT WORK WITHOUT WATER.  
LES POMPES A BORD DE CETTE UNITE NE PEUVENT PAS FONCTIONNER SANS EAU.  
LE POMPE A BORDO DI QUESTA UNITÀ NON POSSONO FUNZIONARE SENZA ACQUA**

#### Instruction for the movimentation - Outside the packaging

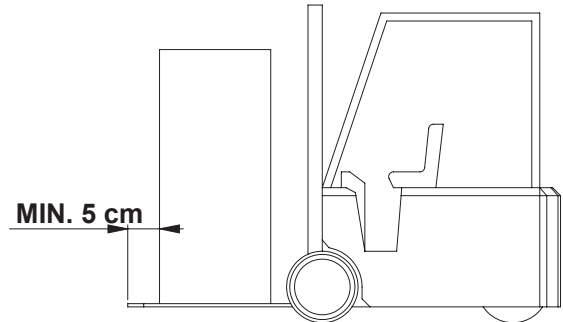

#### Sequence phase control on the electrical board

**ATTENZIONE**  
QUESTO COMPRESSORE RICHIEDE UN CORRETTO SENSO DI ROTAZIONE  
RISPETTARE LA CORRETTA SEQUENZA DELLE FASI  
**CAUTION**  
THIS COMPRESSOR REQUIRES PROPER DIRECTION OF ROTATION  
CHECK PROPER ELECTRICAL PHASING  
**ACHTUNG**  
KOMPRESSOREN BENÖTIGEN KORREKTES DREHFELD.  
ELEKTRISCHE ANSCHLÜSSE AUF DREHFELD ÜBERPRÜFEN  
**ATTENTION**  
CES COMPRESSEURS NECESSITENT UN BON SENSE DE ROTATION  
VERIFIER LE CABLAGE DES PHASES  
**ATENCIÓN**  
ESTOS COMPRESORES DEBEN FUNCIONAR EN EL SENTIDO DE ROTACIÓN CORRECTO  
COMPROBAR EL CABLEADO DE LAS FASES

#### Gravity centre - Base

TENERE SU QUESTA LINEA  
GANCIO DI SOLLEVAMENTO

KEEP LIFT HOOK  
ON THIS LINE

#### Instruction for the lifting

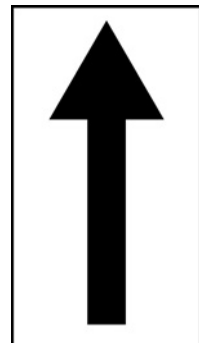



## 2 - Safety (continued)

### Electrical warning Adjacent to the master switch

|   |   |  |
|---|---|--|
|  | <b>ATTENZIONE !</b>                         | <b>ATTENTION !</b>                               |
|   | Prima di aprire togliere tensione           | Enlever l'alimentation électrique avant d'ouvrir |
| <b>ACHTUNG !</b>  | <b>CAUTION !</b>                            | <b>ATENCIÓN !</b>                                |
| Vor öffnen des gehäuses hauptschalter ausschalten                                 | Disconnect electrical supply before opening | Cortar la corriente antes de abrir el aparato    |

### Commissioning - Outside, on the left-hand front column

**GB ATTENTION: IMPORTANT NOTICE FOR COMMISSIONING**

Before the start up make sure:

- that the shipping protection has been removed
- that all gas shut off valves, compressor suction and discharge valves, liquid line valves have been opened- Note: open all shut off valves completely (loosen the stuffing nut, if necessary) and check the seal
- that all electrical circuit screws are well-tightened
- that there is no oil trace in the refrigerant circuit
- that the connections of lines have been started at least 12 hours before the start-up (touch compressor body by one hand)
- the compressor oil level through the compressor sight glass
- the evaporator water flow rate and its pressure drop

**I ATTENZIONE: ISTRUZIONE PER IL PRIMO AVVIAMENTO**

Prima dell'avviamento verificare:

- Che la protezione di spedizione sia stata rimossa
- Che tutti i rubinetti del gas, mandata e aspirazione compressore, linea del liquido siano stati aperti
- Note: aprire completamente tutti i rubinetti (allentando se serve il premontaggio) e verificare la tenuta
- Che tutte le viti del circuito elettrico siano ben serrate
- Che non ci siano macchie di olio nel circuito frigorifero
- Che la resistenza olio del Carter sia stata avviata almeno 12 ore prima dell'avviamento (toccare la base del compressore con una mano)
- Il livello olio dei compressori attraverso il vetro spia del compressore
- La corrente portata d'acqua all'evaporatore, e le sue perdite di carico

**D ACHTUNG: WICHTIGER INBETRIEBNAHME-HIN WEIS**

Vor der Inbetriebnahme bitte folgende überprüfen:

- dass der Versandenschutz entfernt worden ist
- dass alle Gasventile, Förder- und Saugventile vom Kompressor und die Leitung der Flüssigkeit geöffnet worden sind
- Note: alle Ventile vollständig öffnen (wenn nötig, die Stopfbüchse lösen) und die Dichtungen prüfen
- dass alle Schrauben vom Stromkreis gut festgezogen sind
- dass kein Öl-Fleck im Kältemittel vorhanden ist
- dass der Ölwanne vom Gehäuse wenigstens 12 Stunden vor der Inbetriebnahme gestartet worden ist (die Basis vom Kompressor mit einer Hand berühren)
- den Ölstand der Kompressoren durch das Schauglas vom Kompressor
- den richtigen Evaporator-Wasserdurchsatz und dessen Strömungsverluste

**F ATTENTION: INSTRUCTIONS POUR LA PREMIERE MISE EN ROUTE**

Avant le démarrage à assurer:

- qu'on a enlevé la protection d'expédition
- qu'on a ouvert tous les robinets du gaz, de refoulement et aspiration du compresseur, ligne du liquide- Note: ouvrir complètement tous les robinets (desserer le presse-étoupe si nécessaire) et vérifier l'étanchéité
- qu'on a bien serré tous les vis du circuit électrique
- qu'il n'y a pas de traces d'huile dans le circuit frigorifique
- qu'on a démarré la résistance huile du Carter au moins 12 heures avant le démarrage (toucher la base du compresseur avec une main)
- le niveau d'huile des compresseurs à travers le regard du compresseur
- le débit correct de l'eau à l'évaporateur et ses pertes de charge

**E ATENCIÓN: INSTRUCCIONES PARA LA PRIMERA PUESTA EN MARCHA**

Antes de la puesta en marcha comprobar:

- Que la protección de envío se haya quitado
- Que todos los grifos del gas, descarga y aspiración compresor, línea del líquido se hayan abierto
- Note: abra completamente todos los grifos (en su caso alfundeje el premontaje) y compruebe la estanqueidad
- Que todas las tornillos de circuito eléctrico estén bien apretados
- Que no haya manchas de aceite en el circuito de refrigeración
- Que la resistencia aceite del cárter se haya puesto en marcha al menos 12 horas antes del arranque (toque la base del compresor con una mano)
- El nivel de aceite de los compresores a través de la mirilla del compresor
- El caudal de agua correcto al evaporador, y sus pérdidas de carga

### Final Test Certificate - Inside the external door

| CERTIFICATO DI COLLAUDO PRODUZIONE<br>PRODUCTION TEST CERTIFICATE |   |                             |
|---|---|-----------------------------|
| PROOF CHECK NUMBER  | DESCRIZIONE DEI TEST<br>DESCRIPTION OF QUALITY CHECK  | TEMPO OFFERT<br>IN-SP. CODE |
| 1   | VERIFICA ASSEMBLAGGIO<br>CHECK ASSEMBLY PARTS   |                             |
| 2   | VERIFICA VISIVA CABLAGGIO<br>COLLEG. ELETTRICI E CONNESSIONE<br>CHECK WIRING CONNECTION                                       |                             |
| 3   | VUOTO E CARICA<br>VACUUM AND REFRIGERANT CHARGE   |                             |
| 4   | VERIFICA CON CERCAFUGHE<br>TENUTA CIRCUITO FRIGORIFERO<br>REFRIGERANT LEAK TEST   |                             |
| 5   | TEST SICUREZZA ELETTRICA<br>SAFETY TEST   |                             |
| 6   | PROVE FUNZIONALI CON RILIEVI<br>TEMPERATURE PRESSIONI RUMORI<br>FUNCTIONAL AND RUN TEST: NOISE TEST                           |                             |
| 7   | VERIFICA INTERVENTI SICUREZZE<br>PRESSIONE E TEMPERATURA<br>CHECK SAFETY DEVICES  |                             |
| 8   | VERIFICA VISIVA SONDE<br>VISUAL CHECK SENSOR  |                             |
| 9   | VERIFICA TENUTA CIRCUITO IDR.<br>E FUNZIONAMENTO POMPA (EU PACK)<br>HYDRAULIC CIRCUIT TEST<br>(PUMP CHECK ONLY FOR PACK UNIT) |                             |
| 10  | VERIFICA MONTAGGIO ACCESSORI<br>(SE PRESENTI) E DOCUMENTAZIONE<br>CHECK ACCESSORIES DOCUMENTATION                             |                             |
| 11  | CONTROLLO ESTETICO FINALE TENUTA CIRCUITO E PULIZIA<br>VISUAL CHECK/LEAK FINAL TEST<br>AND CLEANING ASPECTS                   |                             |

### Grounding connection on the electrical board, adjacent to the connection

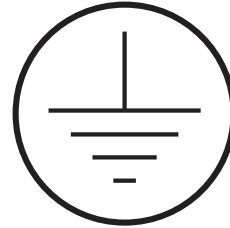

### Read the instruction on the electrical board



### Fitting identification - Adjacent to fittings

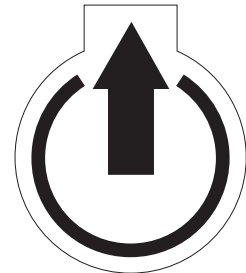
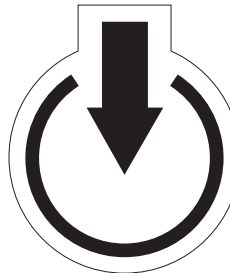

## 2 - Safety (continued)

### Identification of refrigerant - Below identification of the unit

Contains fluorinated greenhouse gases covered by the Kyoto-Protocol.  
Contiene gas fluorurati ad effetto serra disciplinati dal Protocollo di Kyoto.  
Contient des gaz à effets de serre fluorés couverts par le Protocol de Kyoto.  
Enthält fluorierte Treibhausgase die vom Kyoto-Protokoll erfasst sind.  
Contiene gases fluorados de efecto invernadero cubiertos por el Protocolo de Kyoto.

### Parameter configuration - Inside the electrical board

#### **IMPORTANT !**

**NOTE:** always check configuration parameters value setting after any reset or Control Board replacement.

**NOTA:** controllare sempre valori parametri configurazione dopo ogni reset o sostituzione scheda controllo.

**ANMERKUNG:** nach jeder Rücksetzung oder nach dem Ersatz der Steuerkarte immer die Konfigurationsparameterwerte prüfen

**NOTE:** contrôler toujours les valeurs des paramètres de configuration après chaque remise à zéro ou remplacement de la carte de contrôle

**NOTA:** controlar siempre los valores de los parámetros de configuración después de cada puesta a cero o sustitución de la tarjeta de control.

### Pump drain - Outside, on the right-hand front column

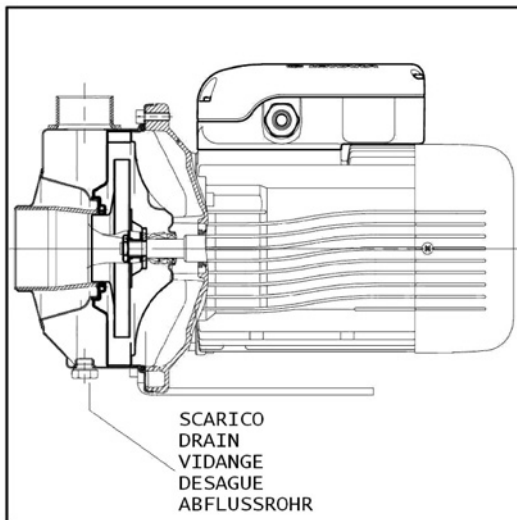

### Circuit drain - Outside, on the right-hand front column



**ATTENTION!** Don't leave the unit with water inside hydraulic circuit during winter or when it is in stand by.  
**ATTENZIONE!** Non lasciare l'unità con acqua nel circuito idraulico durante l'inverno o quando non è funzionante.  
**ATTENTION!** Ne laissez pas l'unité avec de l'eau dans le circuit hydraulique pendant l'hiver ou quand elle ne travaille pas.  
**WARNING!** Lassen Sie nicht das Wasser in die Schaltung während des Winters oder wenn es nicht funktioniert.  
**¡ATENCIÓN!** No deje el agua en el circuito hidráulico durante el invierno o cuando no está trabajando.

### Filter / flow switch - Outside, on the right-hand front column



**E' OBBLIGATORIO L'USO DI FILTRO E FLUSSOSTATO ACQUA  
THE USE OF FILTER AND FLOW SWITCH IS MANDATORY  
EL USO DEL FILTRO Y DEL INTERRUPTOR DE FLUJO ES OBLIGATORIO  
L'UTILISATION DU FILTRE ET DU FLUXOSTAT EST OBLIGATOIRE  
DER GEBRAUCH VON FILTER UND STRÖMUNGSWÄCHTER IST  
VORGESCHRIEBEN.**

## 2 - Safety (continued)

### 2.8 Safety regulations

| REFRIGERANT DATA                        | SAFETY DATA: R410A  |
|---|---|
| <b>Toxicity</b>                         | Low   |
| <b>Contact with skin</b>                | <p>If sprayed, the refrigerant is likely to cause frost burns. If absorbed by the skin, the danger is very limited; it may cause a slight irritation, and the liquid is degreasing. Unfreeze the affected skin with water. Remove the contaminated clothes with great care - in the presence of frost burns, the clothes may stick to the skin. Wash with plenty of warm water the affected skin.</p> <p>In the presence of symptoms such as irritation or blisters, obtain medical attention.</p>  |
| <b>Contact with eyes</b>                | <p>Vapours do not cause harmful effects. The spraying of refrigerant may cause frost burns. Wash immediately with a proper solution or with tap water for at least 10 minutes, and then obtain medical attention.</p>   |
| <b>Ingestion</b>                        | <p>Very unlikely - should something happen, it will cause frost burns.</p> <p>Do not induce vomiting. Only if the patient is conscious, wash out mouth with water and give some 250 ml of water to drink. Then, obtain medical attention.</p>   |
| <b>Inhalation</b>                       | <p>R410A: remarkable concentrations in the air may have an anaesthetic effect, up to fainting.</p> <p>The exposure to considerable amounts may cause irregular heartbeat, up to the sudden death of the patient. Very high concentrations may result in the risk of asphyxia, due to the reduction in the oxygen percentage in the atmosphere. Remove the patient to fresh air and keep warm and at rest.</p> <p>If necessary, give oxygen. In case of breathing difficulties or arrest, proceed with artificial respiration.</p> <p>In case of cardiac arrest, proceed with cardiac massage. Then, obtain medical attention.</p> |
| <b>Recommendations</b>                  | <p>Semiotics or support therapy is recommended. Cardiac sensitisation has been observed that, in the presence of circulating catecholamines such as adrenalin, may cause cardiac arrhythmia and accordingly, in case of exposure to high concentrations, cardiac arrest.</p>  |
| <b>Prolonged exposure</b>               | <p>R410A: a study on the effects of exposure to 50,000 ppm during the whole life of rats has identified the development of benign testicle tumour.</p> <p>This situation should therefore be negligible for personnel exposed to concentrations equal to or lower than professional levels.</p>   |
| <b>Professional levels</b>              | R410A: Recommended threshold: 1000 ppm v/v - 8 hours TWA.   |
| <b>Stability</b>                        | R410A: Not specified  |
| <b>Conditions to avoid</b>              | Do not use in the presence of flames, burning surfaces and excess humidity.   |
| <b>Hazardous reactions</b>              | <p>May react with sodium, potassium, barium and other alkaline metals.</p> <p>Incompatible substances: magnesium and alloys with magnesium concentrations &gt; 2%.</p>  |
| <b>Hazardous decomposition products</b> | R410A: Halogen acids produced by thermal decomposition and hydrolysis.  |

## 2 - Safety (continued)

### 2.8 Safety regulations (continued)

| REFRIGERANT DATA                          | SAFETY DATA: R410A  |
|---|---|
| <b>General precautions</b>                | Do not inhale concentrated vapours. Their concentration in the atmosphere should not exceed the minimum preset values and should be maintained below the professional threshold. Being more weighty than the air, the vapour concentrates on the bottom, in narrow areas. Therefore, the exhaust system must work at low level.   |
| <b>Respiratory system protection</b>      | If you are in doubt about the concentration in the atmosphere, it is recommended to wear a respirator approved by an accident-prevention Authority, of the independent or oxygen type.  |
| <b>Storage</b>                            | Cylinders must be stored in a dry and fresh place, free from any fire hazard, far from direct sunlight or other sources of heat, radiators etc.<br>Keep a temperature below 50 °C.  |
| <b>Protective clothing</b>                | Wear overalls, protective gloves and goggles or a mask.   |
| <b>Accidental release measures</b>        | It is important to wear protective clothing and a respirator.<br>Stop the source of the leak, if you can do this without danger. Negligible leaks can be left evaporating under the sun, providing that the room is well ventilated.<br>Considerable leaks: ventilate the room. Reduce the leak with sand, earth or other absorbing substances.<br>Make sure that the liquid does not channelled into gutters, sewers or pits where the vapours are likely to create a stuffy atmosphere. |
| <b>Disposal</b>                           | The best method is recovery and recycling. If this method is not practicable, dispose according to an approved procedure, that shall ensure the absorption and neutralization of acids and toxic agents.  |
| <b>Fire fighting information</b>          | R410A: Not flammable in the atmosphere.   |
| <b>Cylinders</b>                          | The cylinders, if exposed to fire, shall be cooled by water jets; otherwise, if heated, they may explode.   |
| <b>Protective fire fighting equipment</b> | In case of fire, wear an independent respirator and protective clothing.  |

## 2 - Safety (continued)

### 2.8 Safety regulations (continued)

| LUBRICANT OIL DATA                          | SAFETY DATA: POLYESTER OIL (POE)  |
|---|---|
| <b>Classification</b>                       | Not harmful.  |
| <b>Contact with skin</b>                    | May cause slight irritation. Does not require first aid measures. It is recommended to follow usual personal hygiene measures, including washing the exposed skin with soap and water several times a day. It is also recommended to wash your overalls at least once a week. |
| <b>Contact with eyes</b>                    | Wash thoroughly with a suitable solution or tap water.  |
| <b>Ingestion</b>                            | Seek medical advice immediately.  |
| <b>Inhalation</b>                           | Seek medical advice immediately.  |
| <b>Conditions to avoid</b>                  | Strong oxidising substances, caustic or acid solutions, excess heat.<br>May corrode some types of paint or rubber.  |
| <b>Protection of the respiratory system</b> | Use in well ventilated rooms.   |
| <b>Protective clothing</b>                  | Always wear protective goggles or a mask. Wearing protective gloves is not mandatory, but is recommended in case of prolonged exposure to refrigerant oil.  |
| <b>Accidental release measures</b>          | It is important to wear protective clothing and, especially, goggles.<br>Stop the source of the leak. Reduce the leak with absorbing substances (sand, sawdust or any other absorbing material available on the market).  |
| <b>Disposal</b>                             | The refrigerant oil and its waste will be disposed of in an approved incinerator, in conformity with the provisions and the local regulations applicable to oil waste.  |
| <b>Fire fighting information</b>            | In the presence of hot liquid or flames, use dry powder, carbon dioxide or foam. If the leak is not burning, use a water jet to remove any vapours and to protect the personnel responsible for stopping the leak.  |
| <b>Cylinders</b>                            | The cylinders exposed to a fire will be cooled with water jets in case of fire.   |
| <b>Fire fighting protective equipment</b>   | In case of fire, wear an independent respirator.  |

## 3 - Transport, Handling and Storage

WQL / WQH / WQRC units are supplied fully assembled and tested (except for accessories supplied loose in the units – absorbers, filter, etc.). They are ready to be installed and started on the field.

R410A units are only charged with liquid refrigerant and with oil in the quantity required for operation.



The low pressure side of the refrigerating circuit on R410A units shall be charged by means of the service valve arranged on the thermal expansion valve before the device is operated.

### 3.1 Inspection

The unit shall be immediately inspected upon receipt to find out any damage since it has been delivered ex works and transported at the customer's risk. It is also necessary to make sure that all the parcels specified on the delivery note have been delivered.

Any damage you may find out shall be immediately reported in writing to the carrier. Even if the damage is only on the surface, please notify our local representative too.

The manufacturer disclaims all responsibility for the shipment even if it has provided for its organisation.

### 3.2 Handling

WQL / WQH / WQRC units are designed to be lifted from above, by means of cables and eyebolts. A spacer shall be arranged between the cables in order to prevent them from damaging the unit (see the figure aside).

Before handling the devices, make sure the site you have chosen for the installation can withstand its weight and support its mechanical impact.

Avoid touching sharp parts while handling the unit.



The unit shall never be placed on rollers.

Act as follows to lift and handle the unit:

- Insert and secure the eyebolts into the frame holes which have been marked on purpose.
- Connect the cables to the eyebolts.
- Insert the spacer between the cables.
- Provide for hooking at the centre of gravity of the device.
- Cables shall have such a length that the angle they form with the horizon when under tension is not less than 45°.

Space requirements request to handling

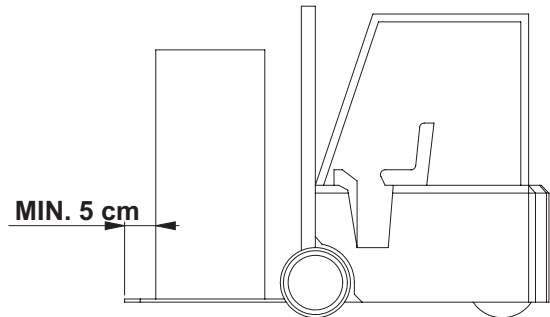

MIN. 5 cm

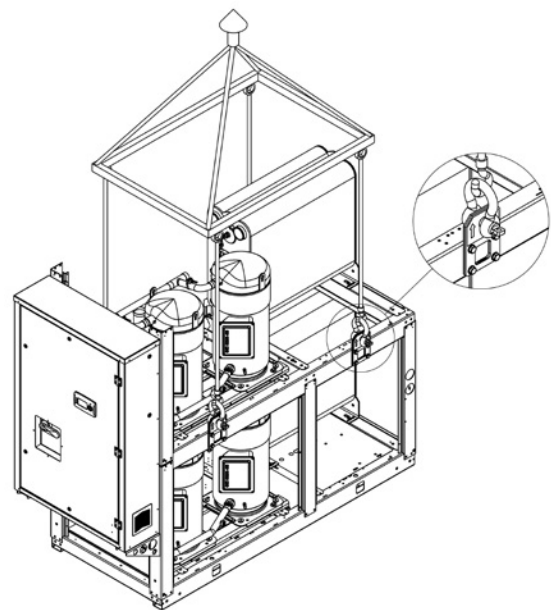

While lifting and handling the unit, pay attention. Otherwise, you might damage the finned block of the coils arranged on both sides of the unit. The sides of the unit shall be protected by cardboard or plywood sheets.

## 3 - Transport, Handling and Storage

### 3.3 Anchoring

It is not essential to secure the unit to the foundations, unless in areas where there is a serious risk of earth-quake, or if the appliance is installed on the top of a steel frame.

### 3.4 Storage

If the unit is to be stored before the installation for some time, take at least the following precautions to prevent damage, corrosion and/or deterioration:

- Make sure all openings, such as for example water connections, are well plugged and sealed.
- Never store the units in a room where temperature is above 50 °C (R410A units) or where the units are directly exposed to the sunlight.

- Minimum storage temperature is -25 °C.
- Store the units in areas where minimum activity is likely to take place in order to avoid any risk of accidental damage.
- Never use steam to clean the unit.
- Remove all the keys required to have access to the control panel and give them to the person in charge of the field.

It is also recommended to provide for visual inspections at regular intervals.

## 4 - Installation

### 4.1 Positioning of the unit



Before installing the unit, make sure that the structure of the building and/or the supporting surface can withstand the weight of the appliance. The weights of the units are listed in Chapter 8 of this manual.

These units have been designed for indoor installation on a solid surface. Standard accessories include antivibrating rubber supports, that must be positioned under the base.

When the unit is to be installed on the ground, it is necessary to provide a concrete base, to ensure a uniform distribution of the weights.

As a general rule, no special sub-bases are required. However, if the unit is to be installed on the top of inhabited rooms, it is advisable to rest it on spring shock absorbers (optional), that will minimise the transmission of any vibration to the structures.

To choose the place of installation of the unit, bear in mind that:

- the unit must not be installed in areas subject to flooding, under gutters etc.
- the place of installation must be have all the necessary spaces for air circulation and maintenance operations (see Chapter 8).

### 4.2 Spring Isolator Installation

- Prepare the base, that must be flat and plane.
- Lift the appliance and insert shock absorbers as follows:

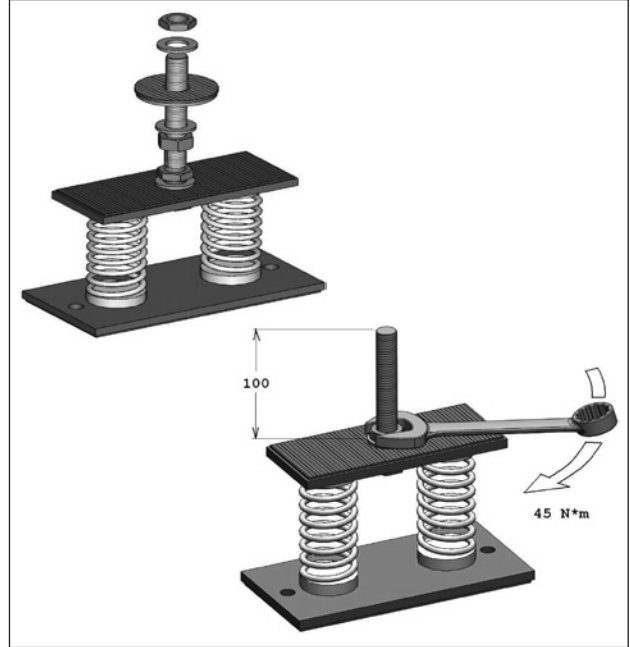

- 1) Proceed to assemble the jack components. Fit the jack in the threaded housing on the upper plate of the antivibration mount.

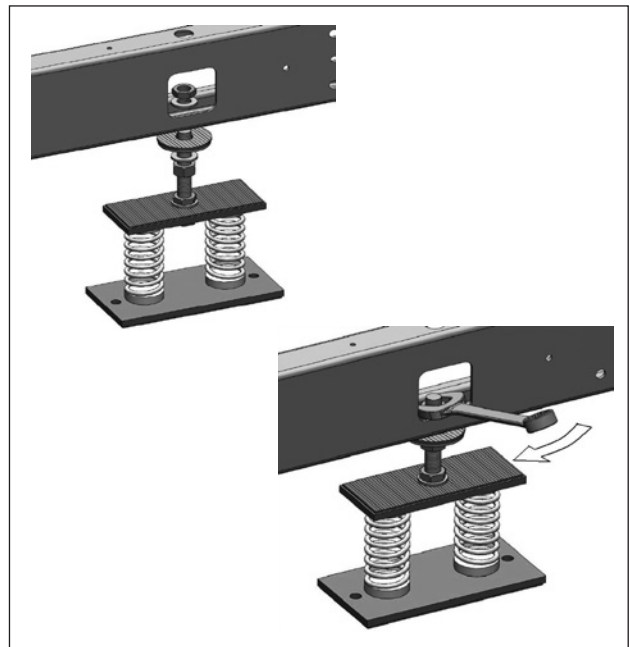

- 2) Fit the jack mounted on the antivibration mount in the hole in the machine base.



## 4 - Installation (continued)

### 4.3 Internal/external Water Circuit

The flow switch and the filter water, although not included in the supply, must always be fitted such as plant components. Their installation is mandatory for warranty.



The internal/external water circuit shall guarantee a constant water flow rate through the circulating refrigerant/water heat exchangers under steady operating conditions and in case of a load variation.

The circuit shall be composed by the following elements:

- A circulation pump which can ensure the necessary flow rate and head.
- The total content of the primary water circuit shall never be lower than 5 l/kW in terms of refrigerating capacity. If the total water volume in the primary circuit should be unable to reach such a value, an additional heat-insulated storage tank should be installed. This tank is intended to avoid any repetitive start of the compressor.
- A membrane expansion tank complete with a safety valve and a drain which shall be visible.



The expansion tank shall be dimensioned in such a way that it can absorb a 2% expansion of the total volume of the water in the plant (exchanger, pipelines, uses and storage tank, if available).

The expansion tank shall never be insulated when the circulating fluid is not flowing through it.

A water pressure differential switch is mounted as a standard. It will stop the unit whenever a flow rate problem occurs.

In addition:

- Install on/off valves (accessory) on the lines at the inlet and outlet of the manifolds of the exchangers.
- Arrange a by-pass complete with an on/off valve between the manifolds of the heat exchangers.
- Arrange air vent valves at the high points of the water lines.
- Arrange drain points complete with plugs, clocks, etc. in the proximity of the low points of the water lines.
- Insulate the water lines to prevent the heat from blowing back into the unit.

## 4 - Installation (continued)

### WQL - WQH 524 / 1204 HYDRAULIC SYSTEM BASIC

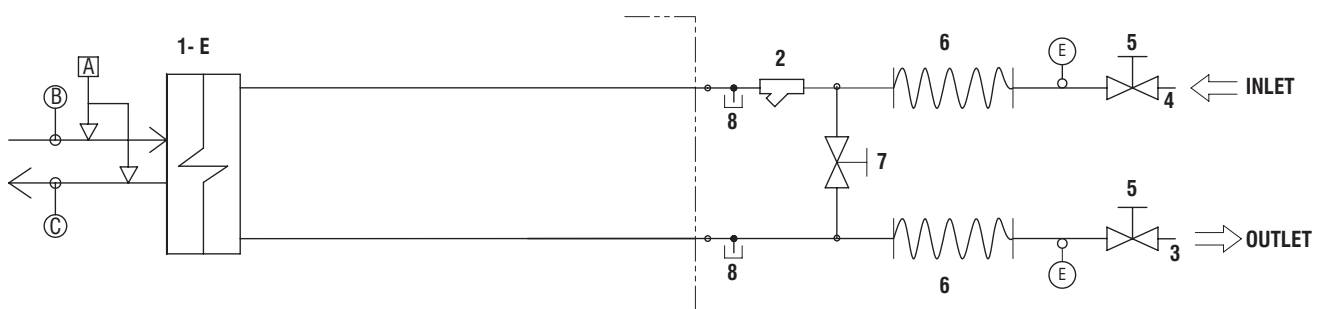
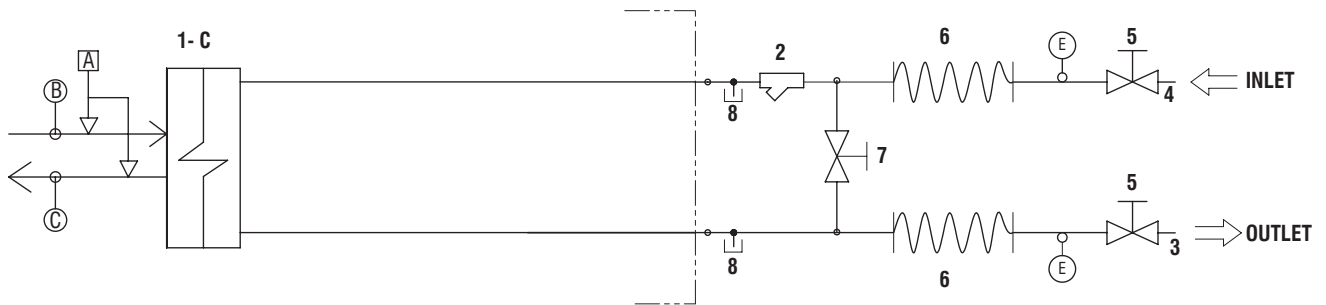

| COMPONENTS |                         |
|------------|-------------------------|
| <b>1C</b>  | Condenser               |
| <b>1E</b>  | Evaporator              |
| <b>2</b>   | Water filter            |
| <b>3</b>   | Water outlet            |
| <b>4</b>   | Water inlet             |
| <b>5</b>   | Globe valve             |
| <b>6</b>   | Flexible pipes          |
| <b>7</b>   | By pass valve           |
| <b>8</b>   | Pressure point/drainage |

| SAFETY/CONTROL DEVICES |   |
|------------------------|---|
| <b>A</b>               | Water differential pressure switch.....() |
| <b>B</b>               | Inlet water temperature sensor            |
| <b>C</b>               | Outlet water temperature sensor           |
| <b>D</b>               | Vent valve                                |
| <b>E</b>               | Thermometer                               |
| ---                    | Unit side                                 |
| ○                      | Probes                                    |

# 4 - Installation (continued)

## WQL - WQH 524 / 1204 HYDRAULIC SYSTEM 1P CONDENSER 1P EVAPORATOR

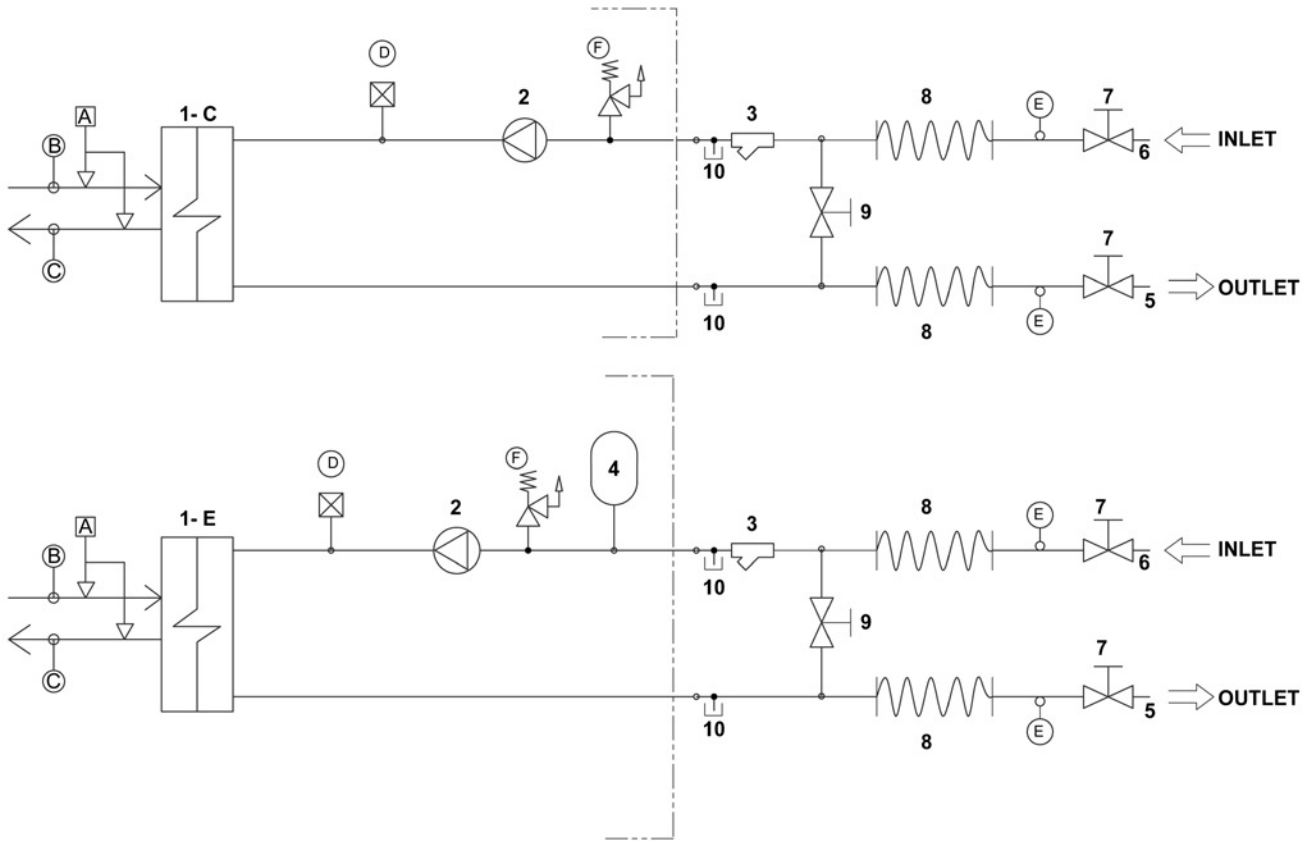

| COMPONENTS |                         |
|------------|-------------------------|
| <b>1C</b>  | Condenser               |
| <b>1E</b>  | Evaporator              |
| <b>2</b>   | Pump                    |
| <b>3</b>   | Water filter            |
| <b>4</b>   | Pressure expansion tank |
| <b>5</b>   | Water outlet            |
| <b>6</b>   | Water inlet             |
| <b>7</b>   | Globe valve             |
| <b>8</b>   | Flexible pipes          |
| <b>9</b>   | By pass valve           |
| <b>10</b>  | Pressure point/drainage |

| SAFETY/CONTROL DEVICES |   |
|------------------------|---|
| <b>A</b>               | Water differential pressure switch.....() |
| <b>B</b>               | Inlet water temperature sensor            |
| <b>C</b>               | Outlet water temperature sensor           |
| <b>D</b>               | Vent valve                                |
| <b>E</b>               | Thermometer                               |
| <b>F</b>               | Water safety valve (6BAR)                 |
| ----                   | Unit side                                 |
| <b>O</b>               | Probes                                    |

## 4 - Installation (continued)

### WQL - WQH 50 / 190 HYDRAULIC SYSTEM 2P CONDENSER 2P EVAPORATOR

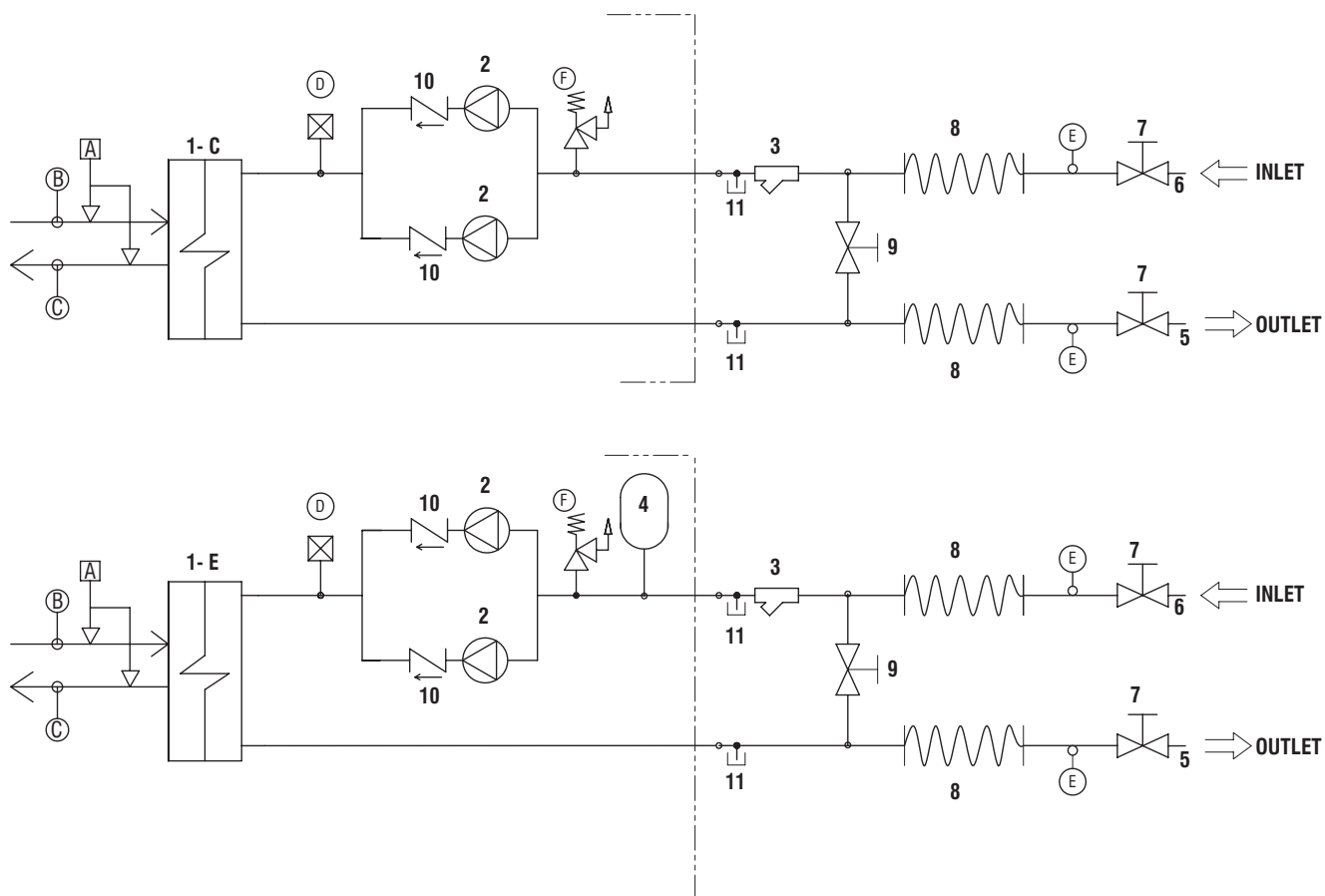

| COMPONENTS |                         |
|------------|-------------------------|
| <b>1C</b>  | Condenser               |
| <b>1E</b>  | Evaporator              |
| <b>2</b>   | Pump                    |
| <b>3</b>   | Water filter            |
| <b>4</b>   | Pressure expansion tank |
| <b>5</b>   | Water outlet            |
| <b>6</b>   | Water inlet             |
| <b>7</b>   | Globe valve             |
| <b>8</b>   | Flexible pipes          |
| <b>9</b>   | By pass valve           |
| <b>10</b>  | Non-return valve        |
| <b>11</b>  | Pressure point/drainage |

| SAFETY/CONTROL DEVICES |   |
|------------------------|---|
| <b>A</b>               | Water differential pressure switch.....() |
| <b>B</b>               | Inlet water temperature sensor            |
| <b>C</b>               | Outlet water temperature sensor           |
| <b>D</b>               | Vent valve                                |
| <b>E</b>               | Thermometer                               |
| <b>F</b>               | Water safety valve... (6BAR)              |
| ----                   | Unit side                                 |
| ○                      | Probes                                    |

## 4 - Installation (continued)

### 4.4 Water connections



The attachments at the water inlet and outlet shall be connected in compliance with the instructions which can be found on the labels in the proximity of the attachments.

Connect the water lines of the plants with the attachments of the unit whose diameters and positions are shown by Chapter 8.

### 4.5 Power supply



Before carrying out any operations on the electrical system, make sure that the unit is deenergised.



**It is important that the appliance is grounded.**



The company in charge of the installation shall conform to the standards applicable to outdoor electrical connections.

**The manufacturer may not be held liable for any damage and/or injury caused by failure to comply with these precautions.**

The unit conforms to EN 60204-1.

The following connections shall be provided:

- A 3-phase and grounding connection for the power supply circuit.
- The electrical distribution system shall meet the power absorbed by the appliance.
- The disconnecting and magnetothermal switches must be sized to control the starting current of the unit.
- The power supply lines and the insulation devices must be designed in such a way that every line independent.
- It is recommended to install differential switches, to prevent any damage caused by phase drops.
- The compressors are supplied through contactors controlled from the control panel.
- Each motor is provided with an internal safety thermal device and external fuses.
- The power supply cables must be inserted into dedicated openings on the front of the unit, and they will enter the electrical board through holes drilled on the bottom of the board.

## 4 - Installation (continued)

### 4.6 Electrical connections

The unit must be installed on site according to the Machinery Directive (2006/42/EC), the Low Voltage Directive (2006/95/EC), the Electromagnetic Interference Directive (2004/108/EC) and the usual procedures and standards applicable in the place of installation.

The unit must not be operated if its installation has not been carried out according to the instructions provided in this manual.

The power supply lines must consist of insulated copper conductors, dimensioned for the maximum absorbed current.

Connection to terminals must be performed according to the diagram of connections (User's Terminal Box) provided in this manual and according to the wiring diagram which accompanies the unit.

|   |  |
|---|--|
|  | Before connecting the power supply lines, check that the available voltage value does not exceed the range specified in the Electric Data (Chapter 8). |
|---|--|

For 3-phase systems, check also that the unbalance between the phases does not exceed 2%. To perform this check, measure the differences between the voltage of each phase couple and their mean value during operation.

The maximum % value of these differences (unbalance) must not exceed 2% of the mean voltage.

If the unbalance is unacceptable, contact the Energy Distributor to solve this problem.

|   |   |
|---|---|
|  | Supplying the unit through a line whose unbalance exceeds the permissible value will automatically void the warranty. |
|---|---|

# 4 - Installation (continued)

## Electrical Connections

### QG - Y1

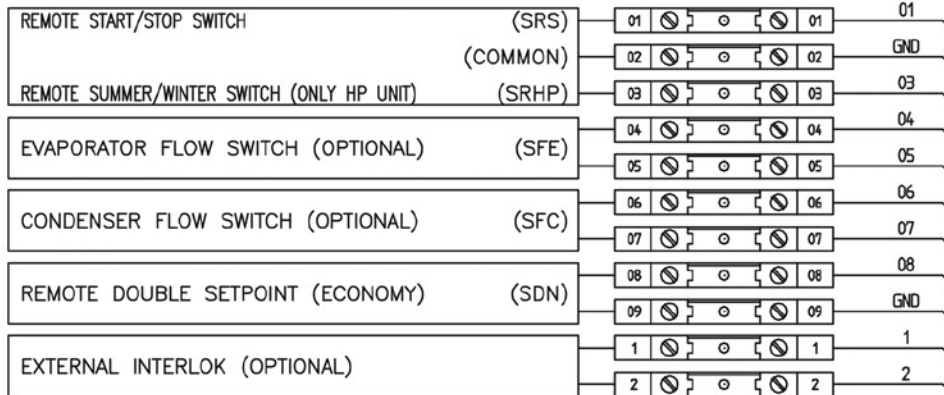

### QG - Y2

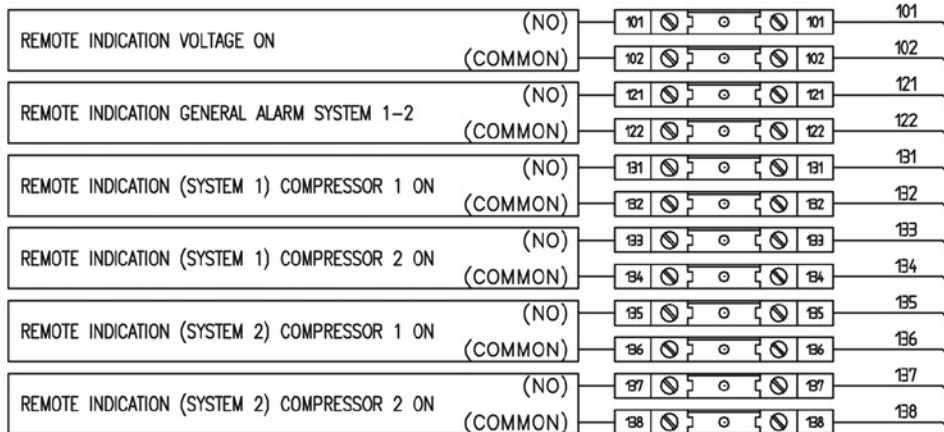

### QG - Y3

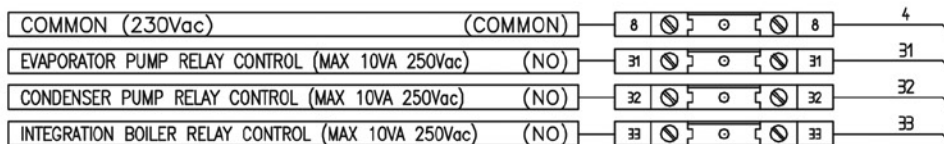

### QG - Y4

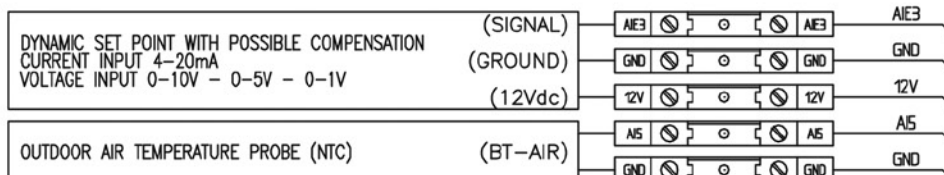

### QG - Y5

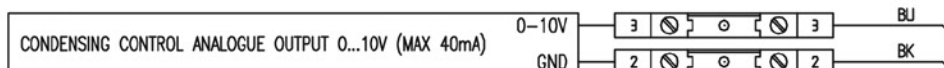

USER TERMINALS

## 5 - Start-Up



The unit must be started for the first time by personnel suitably trained by one Authorised Service Centre. Failure to meet this requirement will immediately void the warranty.



The operations carried out by authorised personnel are limited to the start-up of the unit, and do not include any other operation on the plant, such as, for example, electrical and hydraulic connections etc.

All the other operations before start-up, including oil pre-heating for at least 12 hours, must be performed by the Installer.

### 5.1 Preliminary check

The checks listed below shall be performed before starting the unit and before the arrival of the personnel authorised.

- Check the section of power supply and grounding cables; make sure that terminals are tightened and check the correct operation of contactors, with the main switch open.
- Check that any voltage and phase variation in the power supply does not exceed the prefixed thresholds.
- Connect the contacts of the flow switch and the thermal relay of the pump and of the other devices (if any), to terminals 4-5/6-7 and 1-2, respectively.
- Check that the components of the external water circuit (pump, user equipment, filters, power supply tank and reservoir, if any) have been installed properly, and according to the manufacturer's instructions.
- Check the filling of the hydraulic circuits, and make sure that the fluid circulation is correct, without any trace of leaks and air bubbles. If you use ethylene glycol as antifreeze, check that its percentage is correct (do not exceed 35% glycol percentage).
- Check that the direction of rotation of the pumps is correct, and that fluids have been circulating for at least 12 hours for both pumps. Then, clean the filters on the suction side of the pumps.
- Adjust the liquid distribution network in such a way that the flow rate is within the specified range.
- Check that the water quality is up to the specifications.
- Check that oil heaters, if any, have been turned on at least 12 hours before.

### 5.2 Start-up

Start-up sequence:

- Turn on the Main switch (at least 12 hours before).
- Check that the oil in the compressor has reached the requested temperature (the minimum temperature outside the pan must be approx. 40°C) and that the auxiliary control circuit is energised.
- Check the operation of all the external equipment, and make sure that the control devices of the plant are properly calibrated.

- Start the pump and check that the water flow is correct.
- Set the desired fluid temperature on the control board.
- Start the appliance (see Chapter 6).
- Check the correct direction of rotation of compressors. Scroll compressors cannot compress the refrigerant when they rotate in the opposite direction. To make sure that they are rotating in the correct direction, simply check that, just after the start-up of the compressor, the pressure drops on the LP side and rises on the HP side. Furthermore, if a scroll compressor rotate in the opposite direction, there is a considerable rise in the sound level of the unit, as well as in a dramatic reduction of current absorption compared to normal values. In case of wrong rotation, the scroll compressor can be definitely damaged. Phase monitor is assembled in the unit as a standard to prevent wrong compressors rotation.
- After about 15 minutes of operation check that there are no bubbles, through the sight glass on the liquid line.



The presence of bubbles may indicate that a part of the refrigerant charge has been released in one or more points. It is important to remove these leaks before proceeding.

- Repeat the start-up procedure after removing the leaks.

### 5.3 Checking the operation

Check the following:

- The temperature of the water entering the evaporator/condenser.
- The temperature of the water leaving the evaporator/condenser.
- The level of the water flow rate in the evaporator/condenser.
- The current absorption upon the start of the compressor and in case of stabilised operation.

Check that the condensing and evaporation temperatures, during operation at high and low pressure detected by the pressure gauges of the refrigerant, are within the following range:

(On the units not provided with HP/LP pressure gauges for the refrigerant, connect a pressure gauge to the Schrader valves on the refrigeration circuit).

|         |  |
|---------|--|
| HP side | Approx. 3-5 °C above the temperature of water leaving the condenser, for R410A units.  |
| LP side | Approx. 2 to 4 °C below the temperature of the leaving chilled water, for R410A units. |

### 5.4 Delivery to the customer

- Train the user according to the instructions provided in Section 6.



# 6 - Control

## 6 General information

### Introduction

This document contains the information and the operating instructions for WQL/WQH/WQRC units.

### Main characteristics

- simple user interface with possibility to customize keys functions and to set menus visibility
- parameter setting through keyboard or PC
- thermoregulation → inlet/outlet water probe, according to customer need / application
- auto-adaptive set-point
- dynamic set-point
- alarm log
- analogue input (to be set) → NTC, 4..20mA, 0..1V, 0..5V, 0..10V
- digital input → to be set by parameter
- automatic changeover
- 0-10V analogue condensation control
- advanced pump management (internal/external circuit)

The following accessories can be also connected :

- multi Function Key (MFK) to upload / download parameters map
- serial communication RS485 card; to connect the control to a BMS network
- remote display terminal
- wire remote control

### 6.1 Control of WQL/WQH/WQRC units, double compressor

WQL/WQH/WQRC units are provided with a microprocessor card fully programmed by default for the control of a heat pump unit.

#### General information

It is provided with a display 4 figures on the left, 2 and half (2 1/2) figures plus a sign and 8 buttons, so as to allow the programming of the control parameters (setpoint, differential bands, alarm thresholds) and the main operations to be carried out by the user.

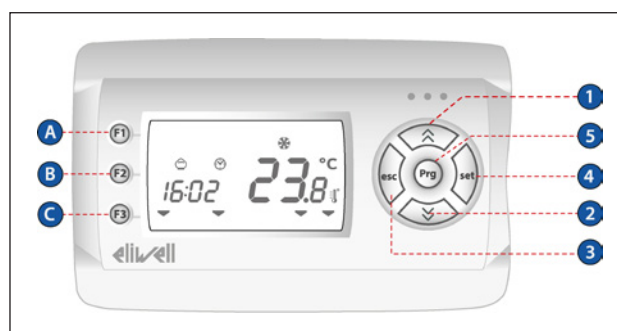















### 6.2 Keypad functions

| KEY | DESCRIPTION        | SINGLE PUSH (PUSH /RELEASE)   |
|-----|--------------------|---|
|     | <b>UP</b>          | - Increase value<br>- Go to next label<br>- Change Set-point                            |
|     | <b>DOWN</b>        | - Decrease value<br>- Go to previous label<br>- Change Set-point (if UI25 = 1)          |
|     | <b>ESC</b>         | - Exit without saving<br>- Go to previous level   |
|     | <b>SET</b>         | - Confirm value / exit with setting saving<br>- Go to next level<br>- Go to status menu |
|     | <b>PROGRAMMING</b> | - Go to the programming folder  |

| LINKED FUNCTION | EXTENDED PUSH (MORE THAN 3s) | MENU/NOTES                   |
|-----------------|------------------------------|------------------------------|
| /               | - Stand-by → ON              | - Stand-by<br>- Local ON/OFF |
| / <b>mode</b>   | - Change mode                | - Menu Mode                  |
| / <b>disp</b>   | - Main display               | - Menu Display               |

## 6 - Control (continued)

| ICON / COLOR   | STEADY ICON                         | BLINKING ICON   |
|--|-------------------------------------|---|
|  GREY   | - Alarm ON                          | - Alarm QUIT  |
|  / GREY | - Mode: HEATING                     | - Antifreeze + Heat pump ON<br>- Heating mode by remote |
|  / GREY | - Mode: COOLING                     | - Cooling mode by remote                                |
|  / GREY | - Mode: STAND-BY                    | - Stand-by mode by remote                               |
|  / GREY | /                                   | /   |
|  / GREY | - Configurable                      | - Configurable  |
|  / GREY | - Current HR<br>- Time slots activ. | - HR setting<br>- Time slots programming                |
| °C / GREY  | /                                   | /   |
| Bar / GREY   | /                                   | /   |
| XR.H. / GREY   | Not used                            | Not used  |
|  / GREY | Menu surf                           | /   |

| LED N°* | DESCRIPTION          | ICON  |
|---------|----------------------|---|
| 1       | First capacity step  |  |
| 2       | Second capacity step |  |
| 3       | Third capacity step  |  |
| 4       | Fourth capacity step |  |
| 5       | Open circuit pump    |  |
| 6       | Primary circuit pump |  |

### 6.3 Folder structure

Folder structure is composed of totally four menus

- 1) Main display → used to set what to display without acting on any key
  - Ai → analogue input (temperature, pressure)
  - rtC → room time clock
  - SetP → standard set-point
  - SetR → corrected set-point (according to climatic correction, etc.)
- 2) Operating mode → used to set operating mode
  - StbY → stand-by
  - HEAT → heating
  - COOL → cooling
- 3) Status → used to show resources values
  - Ai (AIL/AIE/Air) → analogue inputs (main board / expansion board / remote terminal)
  - di (diL/diE) → digital inputs (main board / expansion board)
  - AO (AOL/AOE) → analogue outputs (main board/expansion board)
  - CL (HOUr/dAtE/YEAR) → clock
  - AL (Er00 → Er98) → alarms
  - SP → standard set-point
  - Sr → corrected set-point (according to climatic correction, etc.)
  - Hr → operation hours of compressors / pumps
- 4) Program → define parameters, functions, password and to display alarm log

### 6.4 Menu structure

“Program” menu is composed of totally four folders

- 1) Parameters → change unit parameters
- 2) Functions → manual operations (switch ON / switch OFF, alarm quit, historic alarm delete, multi function key use)
- 3) Password → define visibility levels for parameters/folders
- 4) Alarm log → display alarm log

Parameter folder gives access to following sub-folders

- CL/CE/Cr/CF → configure device I/O (L → local; E → expansion; r → remote; F → serial)
  - analogue inputs (type of probe, range, differential, logic function)
  - digital inputs (logic function)
  - digital outputs (logic function)
  - analogue outputs (range)
  - serial configuration (communication parameters)
- TR → define thermoregulation parameters
  - set-point (max/min/hysteresis)
  - type (proportional/differential)
  - probe selection
- ST → define operating status
  - cooling only
  - heating only
  - scooling and heating
  - change-over
- CP → configure compressor parameters (type/number/timing)
- PI/PE → define primary circuit / source side circuit pump parameters / functions
  - operating mode (disable / always ON / ON if compressor ON)
  - digital / analogue control
  - anti-sticking
  - anti-freeze
- BR → control the parameters for an additional step for heating (boiler)
  - operating mode (disable / differential → fixed or in function of outdoor air temperature)
  - set-point / hysteresis
- DS → define set-point offset (dynamic set-point) depending on
  - analogue input (0...1V, 0...5V, 0...10V, 4...20mA)
  - outdoor air temperature
  - room temperature
- AD → simulate an electronic inertial accumulator, acting on set-point and hysteresis (adaptive function), by confronting minimum / effective ON-OFF time
- HP → define heat pump block management parameters
  - outdoor air temperature
  - thermoregulation temperature
  - digital input
- PL → define capacity limitation to protect the unit (high/low T, high/low P)
- TE → define time slots management (different operating daily profiles)
- AL → define alarms management (automatic / manual reset, by-pass time, sampling)

## 6 - Control (continued)

### 6.5 Alarm list

| Alarm code | Alarm description                                 | CPS Status | RESET auto/man | Pump Status Internal Circuit | Pump Status External Circuit |
|------------|---|------------|----------------|------------------------------|------------------------------|
| Er00       | General alarm                                     | OFF        | A              | OFF                          | OFF                          |
| Er01       | High pressure (digital) circuit 1                 | OFF (1)    | M              |                              |                              |
| Er02       | High pressure (digital) circuit 2                 | OFF (1)    | M              |                              |                              |
| Er03       | High pressure (analogue) circuit 1                | OFF (1)    | M              |                              |                              |
| Er04       | High pressure (analogue) circuit 2                | OFF (1)    | M              |                              |                              |
| Er05       | Low pressure (digital) circuit 1                  | OFF (1)    | A → M          |                              |                              |
| Er06       | Low pressure (digital) circuit 2                  | OFF (1)    | A → M          |                              |                              |
| Er10       | Thermal protection - circuit 1                    | OFF (1)    | M              |                              |                              |
| Er12       | Thermal protection - circuit 2                    | OFF (1)    | M              |                              |                              |
| Er20       | Internal circuit flow switch                      | OFF        | M              | OFF                          |                              |
| Er21       | Internal circuit thermal pump                     | OFF        | A → M          | OFF                          |                              |
| Er25       | External circuit flow switch                      | OFF        | M              |                              | OFF                          |
| Er26       | External circuit thermal pump                     | OFF        | A → M          |                              | OFF                          |
| Er30       | Internal circuit antifreeze                       | OFF        | A              |                              |                              |
| Er31       | External Circuit antifreeze                       | OFF        | A              |                              |                              |
| Er35       | High temperature                                  | OFF        | A              |                              |                              |
| Er45       | Clock failure                                     |            | A              |                              |                              |
| Er46       | Clock to be set                                   |            | A              |                              |                              |
| Er47       | LAN communication error                           |            | A              |                              |                              |
| Er60       | Internal circuit RWT probe failure                | OFF        | A              | OFF                          |                              |
| Er61       | Internal circuit LWT probe failure                | OFF        | A              | OFF                          |                              |
| Er63       | External circuit RWT probe failure                | OFF        | A              |                              |                              |
| Er64       | External circuit LWT probe failure                | OFF        | A              |                              |                              |
| Er67       | Visualization probe (T/P) failure                 |            | A              |                              |                              |
| Er68       | Outdoor air temperature probe failure             | OFF        | A              |                              |                              |
| Er69       | High pressure transducer failure - Circuit 1 or 2 | OFF        | A              |                              |                              |
| Er73       | Dinamic set-point failure                         |            | A              |                              |                              |
| Er80       | Configuration error                               |            | A              |                              |                              |
| Er81       | Compressor maintenance                            |            | M              |                              |                              |
| Er85       | Internal circuit pump maintenance                 |            | M              |                              |                              |
| Er86       | External circuit thermal pump maintenance         |            | M              |                              |                              |
| Er90       | Alarm hystoric record overcoming                  |            | M              |                              |                              |

1) If alarm is manual type

# 7 - General Description

## 7 General Description

### 7.1 Introduction

The new range of water cooled chillers, includes 14 different capacities, fit for medium-sized, commercial and industrial applications.

All these 8 sizes are available in three versions:

- **WQL: cooling only unit**, requires a cooling tower or a dry cooler for heat dissipation purposes
- **WQRC**: needs a remote condenser for heat dissipation purposes
- **WQH: heat pump**, the hot water's outlet temperature can reach 55°C (in heating mode).

### 7.2 General Specifications

These units are equipped with cabinets made of oven-painted galvanized sheet. The ELN version consists of oven-painted galvanized steel panels, coated inside with a soundproof material to ensure absolutely noiseless operation.

All units are factory-assembled and receive the necessary charge of refrigerant and oil (except for WQRC, which are shipped with a nitrogen charge) for compressors, so that they can be promptly installed. Every single unit is tested by making the water circulate through the heat exchangers, in order to check the performance of the refrigeration circuit.

### 7.3 Compressors

All compressors are of Scroll hermetic type, and the motor is cooled by the sucked gas; they are provided with an oil heater.

All compressors are mounted on rubber shock absorbers, so as to minimise the sound level and the vibration transmission.

### 7.4 Refrigeration circuits

The refrigeration circuit is provided with a thermostatic expansion valve, dehydrating cartridge filter, sight glass with a colour-change humidity indicator, HP and LP pressure switches.

WQH units feature also a 4-ways valve and check valves in order to always run expansion valve and filter in the same way.

WQRC units feature also a solenoid valve and a liquid receiver.

### 7.5 Evaporator

The direct-expansion evaporator is dual type and consists of a welded stainless steel plate-type heat exchanger.

The standard accessories include a closed-cell polyurethane sleeve, and a water pressure differential switch.

### 7.6 Condenser (except for WQRC)

The water-cooled condenser is dual type and consists of a welded stainless steel plate-type heat exchanger.

The standard accessories include a closed-cell polyurethane sleeve (only WQH version) and a water pressure differential switch.

### 7.7 Switchboard

All the electrical devices required to operate the unit are housed inside a separate compartment, which can be accessed from the front side of the appliance, via a panel secured by lock screws.

The switchboard, manufactured to CE standards, includes the master disconnect with external handle locked in the opening position, contactors and thermal protections, fuses for the control circuit, sequence phase controller, water sensor, electronic controller, HP and LP pressure switch, timer (to prevent frequent starts) and terminal board.

## 7 - General Description (continued)

### WQL 524 - 1204 Refrigeration System

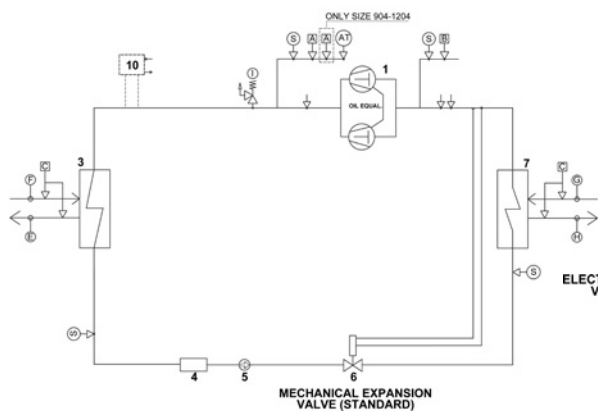

| COMPONENTS |                            |
|------------|----------------------------|
| 1          | Compressor                 |
| 3          | Condenser                  |
| 4          | Drier filter               |
| 5          | Sight glass                |
| 6          | Mechanical expansion valve |
| 7          | Evaporator                 |
| 9          | Electronic expansion valve |
| 10         | Desuperheater              |

| SAFETY / CONTROL DEVICES |  |
|--------------------------|--|
| A                        | High pressure switch (40.5 Bar)          |
| B                        | Low pressure switch (2 Bar)              |
| BT                       | Low pressure transducer                  |
| AT                       | High pressure transducer (optional)      |
| S                        | 5/16" Schrader connection (service only) |
| C                        | Water differential pressure switch       |
| F                        | Inlet water temperature sensor           |
| E                        | Outlet water temperature sensor          |
| D                        | Water differential pressure switch       |
| G                        | Inlet water temperature sensor           |
| H                        | Outlet water temperature sensor          |
| I                        | PED pressure valve (45 Bar)              |
| ↓                        | Pipe connection with Schrader valve      |

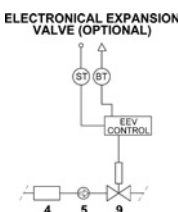

### WQRC 524 - 1204 Refrigeration System

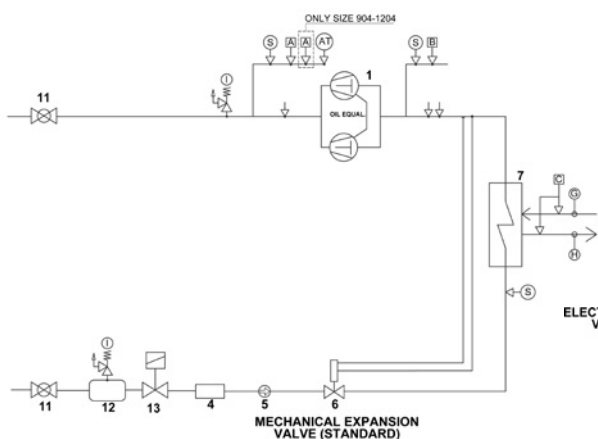

| COMPONENTS |                            |
|------------|----------------------------|
| 1          | Compressor                 |
| 4          | Drier filter               |
| 5          | Sight glass                |
| 6          | Mechanical expansion valve |
| 7          | Evaporator                 |
| 9          | Electronic expansion valve |
| 11         | Globe valve                |
| 12         | Liquid receiver            |
| 13         | Solenoid valve             |

| SAFETY / CONTROL DEVICES |  |
|--------------------------|--|
| A                        | High pressure switch (40.5 Bar)          |
| B                        | Low pressure switch (2 Bar)              |
| AT                       | High pressure transducer (optional)      |
| BT                       | Low pressure transducer                  |
| ST                       | Suction temperature probe                |
| S                        | 5/16" Schrader connection (service only) |
| D                        | Water differential pressure switch       |
| G                        | Inlet water temperature sensor           |
| H                        | Outlet water temperature sensor          |
| I                        | PED pressure valve (45 Bar)              |
| ↓                        | Pipe connection with Schrader valve      |

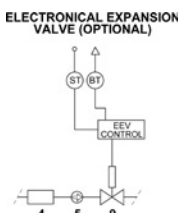

### WQH 524 - 1204 Refrigeration System

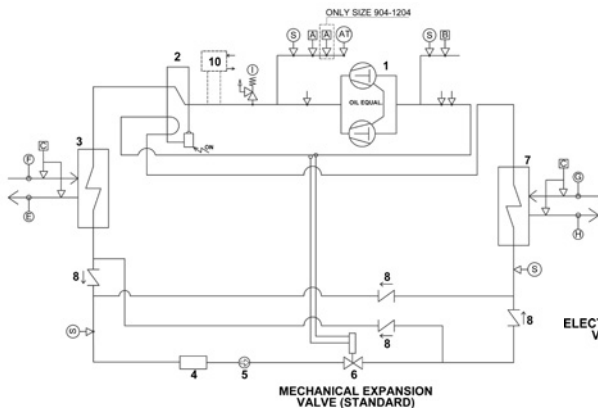

| COMPONENTS |                            |
|------------|----------------------------|
| 1          | Compressor                 |
| 2          | 4 way valve                |
| 3          | Condenser                  |
| 4          | Drier filter               |
| 5          | Sight glass                |
| 6          | Mechanical expansion valve |
| 7          | Evaporator                 |
| 8          | Check valve                |
| 9          | Electronic expansion valve |
| 10         | Desuperheater              |

| SAFETY / CONTROL DEVICES |  |
|--------------------------|--|
| A                        | High pressure switch (40.5 Bar)          |
| B                        | Low pressure switch (2 Bar)              |
| BT                       | Low pressure transducer                  |
| AT                       | High pressure transducer (optional)      |
| S                        | 5/16" Schrader connection (service only) |
| C                        | Water differential pressure switch       |
| F                        | Inlet water temperature sensor           |
| E                        | Outlet water temperature sensor          |
| D                        | Water differential pressure switch       |
| G                        | Inlet water temperature sensor           |
| H                        | Outlet water temperature sensor          |
| I                        | PED pressure relief valve (45 Bar)       |
| ↓                        | Pipe connection with Schrader valve      |

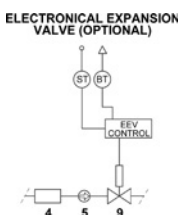

## 7 - General Description (continued)

### 7.8 Accessories

#### Water Filter

2" 1/2 filter (524-804 units) and 4" filter (904-1204 units) is supplied loose and has to be mounted by the customer. (both evaporator and condenser side)

#### Anti-Vibration Kit

Anti-vibration kit made of special rubber pad is provided together with the unit.

#### Water Differential Pressure Switch

Water differential pressure switch is mounted as standard in the unit.

#### Flow switch kit

Flow switch kit is available as an accessory. It is supplied loose and as to be mounted by the customer. Connect terminals of the evaporator flow switch with terminals 4-5 of the electrical box.

Connect terminals of the condenser flow switch with terminals 6-7 of the electrical box.

#### Pump/(s) Kit

One or two 100-150 [kPa] head pressure pump can be mounted as an option (1/2P-SP) both evaporator and condenser side.

One or two 200-250 [kPa] head pressure pump can be mounted as an option (1/2P-HP) both evaporator and condenser side.

#### Phase Monitor Kit

It is assembled on the unit as a standard.

#### Airway Packaging

Complete wooden package for units without refrigerant and with nitrogen precharge. No refrigerant charge is shipped loose with the unit. The customer has to fill the unit through the apposite connection.

#### On/Off Remote Kit

It enables the operator to power on the unit when it is in standby mode, to display alarms and to switch over cooling – heat pump. The kit will include a 3 metre long cable for installation on the wall.i.

#### Sequencer kit - 4 units

It can easily pilot up to 4 units fitted in parallel, 50 metres maximum apart.

#### Gauge kit

Gauge kit is available as an option.

#### Additional heating device kit

It is provided as an option/accessory to allow the unit managing the control of an additional heating device (a boiler in example), in order to integrate the production of hot water.

Connect the additional heating device to terminal 33-8 of the electrical box (refer to Chapt. 4).

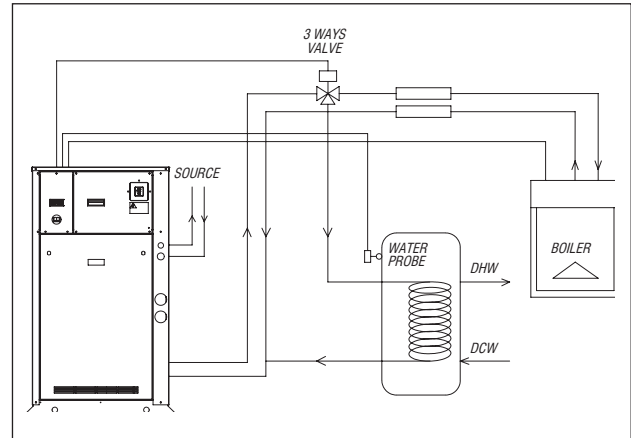

#### Condensing control kit

It is provided as an option/accessory to allow the unit managing the control of condensation, in case very cold water (from a well in example) is entering the condenser. A 0-10V signal (terminal 2-3 of the electrical box / refer to Chapt. 4) is available to manage a variable flow device (in example 2/3 ways modulating valve, inverter pump).

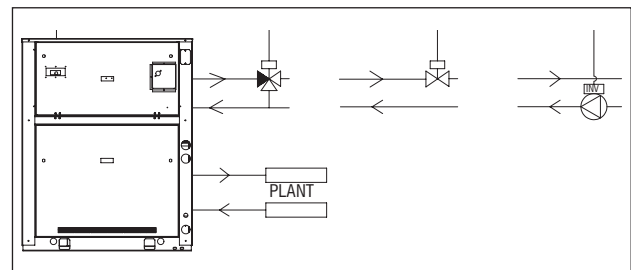

## 7 - General Description (continued)

### Climatic control kit

It is provided as an accessory to allow the unit managing the control of water temperature, according outdoor air temperature. Connect outdoor air temperature probe terminals to terminal AIE5 - GND on the electrical box (refer to Chapt. 4).

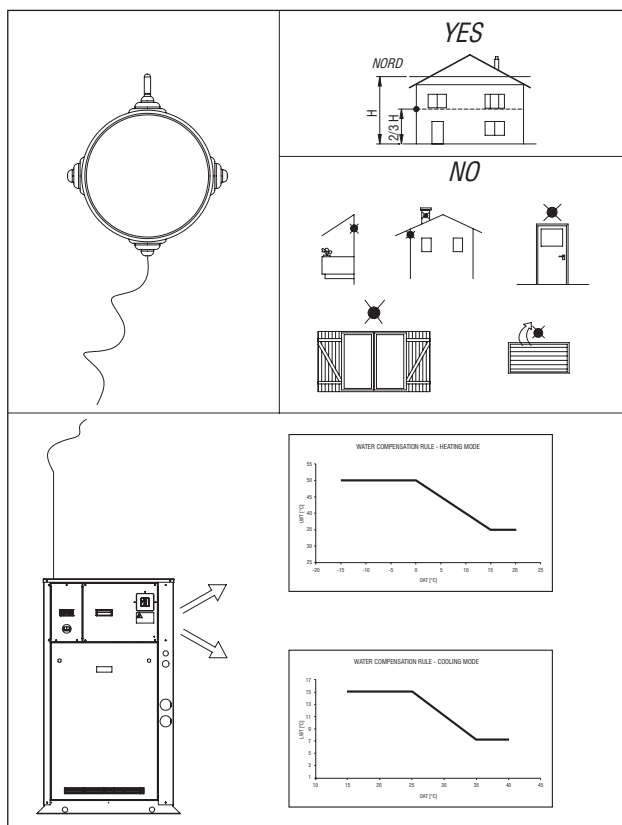

### Antivibrating supports (AVM)

Isolating spring supports, equipped with bolts for fastening to the base. They are supplied separated from the unit and must be mounted on site by the customer, at his own expense.

### Remote wall terminal

Makes it possible to check the unit through a remote terminal, up to a maximum distance of 100 meters.

### RS-485 protocol Modbus

A communication interface makes it possible to control and manage the unit from a local station, with RS485 connection.

It is possible to obtain the remote control and the management, by inserting the control into the management plant of the building.

## 8 - Technical Data

### 8.1 Pressure drops

| PRESSURE DROP IN THE EVAPORATOR |      |      |      |      |      |      |      |      |
|---------------------------------|------|------|------|------|------|------|------|------|
|                                 | 524  | 604  | 704  | 804  | 904  | 1004 | 1104 | 1204 |
| $G_{MIN}$ (l/s)                 | 5,16 | 6,03 | 7,00 | 7,72 | 9,00 | 9,97 | 11,4 | 12,7 |
| $G_{NOM}$ (l/s)                 | 7,22 | 8,44 | 9,80 | 10,8 | 12,6 | 14,0 | 15,9 | 17,7 |
| $G_{MAX}$ (l/s)                 | 12,0 | 14,1 | 16,3 | 18,0 | 21,0 | 23,3 | 26,5 | 29,6 |
| $\Delta P_{MIN}$ (kPa)          | 13,7 | 13,3 | 16,0 | 18,0 | 9,7  | 11,7 | 9,1  | 9,4  |
| $\Delta P_{NOM}$ (kPa)          | 25,5 | 25,0 | 30,3 | 34,2 | 18,3 | 22,2 | 17,2 | 17,7 |
| $\Delta P_{MAX}$ (kPa)          | 65,7 | 65,4 | 79,6 | 90,6 | 47,9 | 58,5 | 44,8 | 46,3 |

| PRESSURE DROP IN THE CONDENSER |      |      |       |       |      |      |      |      |
|--------------------------------|------|------|-------|-------|------|------|------|------|
|                                | 524  | 604  | 704   | 804   | 904  | 1004 | 1104 | 1204 |
| $G_{MIN}$ (l/s)                | 6,31 | 7,44 | 8,59  | 9,50  | 11,0 | 12,2 | 13,9 | 15,5 |
| $G_{NOM}$ (l/s)                | 8,83 | 10,4 | 12,0  | 13,3  | 15,4 | 17,1 | 19,5 | 21,7 |
| $G_{MAX}$ (l/s)                | 14,7 | 17,4 | 20,1  | 22,2  | 25,7 | 28,4 | 32,4 | 36,2 |
| $\Delta P_{MIN}$ (kPa)         | 19,9 | 19,7 | 23,6  | 26,8  | 12,3 | 9,7  | 11,2 | 11,1 |
| $\Delta P_{NOM}$ (kPa)         | 37,1 | 37,2 | 44,6  | 50,9  | 23,3 | 18,3 | 21,0 | 20,9 |
| $\Delta P_{MAX}$ (kPa)         | 95,4 | 97,1 | 117,2 | 134,6 | 61,2 | 47,9 | 55,0 | 54,8 |

| PRESSURE DROP IN THE DESUPERHEATER |      |      |         |          |      |      |
|------------------------------------|------|------|---------|----------|------|------|
|                                    | 524  | 604  | 704-804 | 904-1004 | 1104 | 1204 |
| $G_{MIN}$ (l/s)                    | 0,54 | 0,63 | 0,75    | 1,02     | 1,17 | 1,22 |
| $G_{NOM}$ (l/s)                    | 0,86 | 1,00 | 1,20    | 1,63     | 1,87 | 1,96 |
| $G_{MAX}$ (l/s)                    | 1,44 | 1,67 | 2,01    | 2,72     | 3,11 | 3,26 |
| $\Delta P_{MIN}$ (kPa)             | 1,98 | 2,22 | 1,97    | 3,41     | 4,03 | 2,93 |
| $\Delta P_{NOM}$ (kPa)             | 5,06 | 5,68 | 5,03    | 8,72     | 10,3 | 7,49 |
| $\Delta P_{MAX}$ (kPa)             | 14,0 | 15,8 | 14,0    | 24,2     | 28,7 | 20,8 |



## 8 - Technical Data (continued)

| WQL 524-1204                   | 524   | 604               | 704                 | 804                   | 904                   | 1004                  | 1104                  | 1204                  |
|--------------------------------|---|-------------------|---------------------|-----------------------|-----------------------|-----------------------|-----------------------|-----------------------|
| Number of refrigerant circuits | 2   | 2                 | 2                   | 2                     | 2                     | 2                     | 2                     | 2                     |
| Part load steps                | % 0-25-50-75-100                                  | 0-25-50-75-100    | 0-21-50-71-100      | 0-25-50-75-100        | 0-22-50-72-100        | 0-25-50-75-100        | 0-23-50-73-100        | 0-25-50-75-100        |
| Power supply                   | V/ph/Hz 400V/3/50Hz                               | 400V/3/50Hz       | 400V/3/50Hz         | 400V/3/50Hz           | 400V/3/50Hz           | 400V/3/50Hz           | 400V/3/50Hz           | 400V/3/50Hz           |
| Startup type                   | Direct  |                   |                     |                       |                       |                       |                       |                       |
| <b>REFRIGERANT</b>             |   |                   |                     |                       |                       |                       |                       |                       |
| Type                           | R410A   |                   |                     |                       |                       |                       |                       |                       |
| Charge                         | kg 8.7 / 8.7                                      | 11.1 / 11.1       | 12.6 / 12.6         | 13.4 / 13.4           | 17.2 / 17.2           | 21.3 / 21.3           | 23.8 / 23.8           | 27.4 / 27.4           |
| <b>COMPRESSORS</b>             |   |                   |                     |                       |                       |                       |                       |                       |
| Number                         | 2 / 2   |                   |                     |                       |                       |                       |                       |                       |
| Type                           | Scroll  |                   |                     |                       |                       |                       |                       |                       |
| Crankcase heater               | W 90 - 90 / 90 - 90                               | 90 - 90 / 90 - 90 | 90 - 120 / 90 - 120 | 140 - 140 / 140 - 140 | 140 - 140 / 140 - 140 | 140 - 140 / 140 - 140 | 140 - 140 / 140 - 140 | 140 - 140 / 140 - 140 |
| <b>EVAPORATOR</b>              |   |                   |                     |                       |                       |                       |                       |                       |
| Number                         | 1   |                   |                     |                       |                       |                       |                       |                       |
| Type                           | Plates  |                   |                     |                       |                       |                       |                       |                       |
| Water flow rate                | l/s 7,40  | 8,71              | 10,0                | 11,2                  | 12,7                  | 14,1                  | 16,2                  | 18,2                  |
| Water pressure drop            | kPa 26,7  | 26,6              | 31,5                | 36,3                  | 18,7                  | 22,8                  | 17,8                  | 18,4                  |
| <b>WATER CONNECTIONS</b>       |   |                   |                     |                       |                       |                       |                       |                       |
| Type                           | Victaulic   |                   |                     |                       |                       |                       |                       |                       |
| Inlet diameter                 | inch 2"1/2  | 2"1/2             | 2"1/2               | 2"1/2                 | 4"                    | 4"                    | 4"                    | 4"                    |
| Outlet diameter                | inch 2"1/2  | 2"1/2             | 2"1/2               | 2"1/2                 | 4"                    | 4"                    | 4"                    | 4"                    |
| <b>CONDENSER</b>               |   |                   |                     |                       |                       |                       |                       |                       |
| Number                         | 1   |                   |                     |                       |                       |                       |                       |                       |
| Type                           | Plates  |                   |                     |                       |                       |                       |                       |                       |
| Water flow rate                | l/s 8,97  | 10,6              | 12,2                | 13,6                  | 15,5                  | 17,2                  | 19,7                  | 22,0                  |
| Water pressure drop            | kPa 38,1  | 38,6              | 45,8                | 53,0                  | 23,6                  | 18,6                  | 21,5                  | 21,5                  |
| <b>WATER CONNECTIONS</b>       |   |                   |                     |                       |                       |                       |                       |                       |
| Type                           | Victaulic   |                   |                     |                       |                       |                       |                       |                       |
| Inlet diameter                 | inch 2"1/2  | 2"1/2             | 2"1/2               | 2"1/2                 | 4"                    | 4"                    | 4"                    | 4"                    |
| Outlet diameter                | inch 2"1/2  | 2"1/2             | 2"1/2               | 2"1/2                 | 4"                    | 4"                    | 4"                    | 4"                    |
| <b>DESUPERHEATER</b>           |   |                   |                     |                       |                       |                       |                       |                       |
| Number                         | 2   |                   |                     |                       |                       |                       |                       |                       |
| Type                           | Plates  |                   |                     |                       |                       |                       |                       |                       |
| Water flow rate                | l/s 1,05  | 1,35              | 1,73                | 2,01                  | 2,41                  | 3,26                  | 3,73                  | 3,91                  |
| Water pressure drop            | kPa 8,3   | 4,5               | 5,1                 | 5,7                   | 5,0                   | 8,7                   | 10,3                  | 7,5                   |
| <b>WATER CONNECTIONS</b>       |   |                   |                     |                       |                       |                       |                       |                       |
| Type                           | GAS THREADED MALE CONNECTOR                       |                   |                     |                       |                       |                       |                       |                       |
| Inlet diameter                 | inch 1"   | 1"                | 1"                  | 1"                    | 1"                    | 1"                    | 1"                    | 1"                    |
| Outlet diameter                | inch 1"   | 1"                | 1"                  | 1"                    | 1"                    | 1"                    | 1"                    | 1"                    |
| <b>WEIGHT</b>                  |   |                   |                     |                       |                       |                       |                       |                       |
| Shipping weight (1)            | kg 858  | 929               | 1110                | 1279                  | 1266                  | 1363                  | 1449                  | 1541                  |
| Shipping weight (2)            | kg 961  | 1032              | 1213                | 1382                  | 1369                  | 1466                  | 1552                  | 1644                  |
| Operating weight               | kg 890  | 971               | 1156                | 1329                  | 1340                  | 1453                  | 1552                  | 1660                  |
| Operating weight (2)           | kg 993  | 1074              | 1259                | 1432                  | 1443                  | 1556                  | 1655                  | 1763                  |
| <b>DIMENSIONS</b>              |   |                   |                     |                       |                       |                       |                       |                       |
| Length                         | mm 2250   |                   |                     |                       |                       |                       |                       |                       |
| Width                          | mm 850 (1) / 854 (2) - 885 (1)/(3) - 1005 (2)/(3) |                   |                     |                       |                       |                       |                       |                       |
| Height                         | mm 1845 (1) / 1850 (2)                            |                   |                     |                       |                       |                       |                       |                       |

- (1) BLN VERSION  
(2) ELN VERSION  
(3) ONLY FOR HANDLING

## 8 - Technical Data (continued)

| WQH 524-1204                   |         | 524                         | 604               | 704                 | 804                   | 904                   | 1004                  | 1104                  | 1204                  |
|--------------------------------|---------|-----------------------------|-------------------|---------------------|-----------------------|-----------------------|-----------------------|-----------------------|-----------------------|
| Number of refrigerant circuits |         | 2                           |                   |                     |                       |                       |                       |                       |                       |
| Part load steps                | %       | 0-25-50-75-100              | 0-25-50-75-100    | 0-21-50-71-100      | 0-25-50-75-100        | 0-22-50-72-100        | 0-25-50-75-100        | 0-23-50-73-100        | 0-25-50-75-100        |
| Power supply                   | V/ph/Hz | 400V/3/50Hz                 | 400V/3/50Hz       | 400V/3/50Hz         | 400V/3/50Hz           | 400V/3/50Hz           | 400V/3/50Hz           | 400V/3/50Hz           | 400V/3/50Hz           |
| Startup type                   |         | Direct                      |                   |                     |                       |                       |                       |                       |                       |
| <b>REFRIGERANT</b>             |         |                             |                   |                     |                       |                       |                       |                       |                       |
| Type                           |         | R410A                       |                   |                     |                       |                       |                       |                       |                       |
| Charge                         | kg      | 9.0 / 9.0                   | 11.4 / 11.4       | 13.1 / 13.1         | 13.9 / 13.9           | 17.3 / 17.3           | 21.8 / 21.8           | 24.4 / 24.4           | 27.9 / 27.9           |
| <b>COMPRESSORS</b>             |         |                             |                   |                     |                       |                       |                       |                       |                       |
| Number                         |         | 2 / 2                       |                   |                     |                       |                       |                       |                       |                       |
| Type                           |         | Scroll                      |                   |                     |                       |                       |                       |                       |                       |
| Crankcase heater               | W       | 90 - 90 / 90 - 90           | 90 - 90 / 90 - 90 | 90 - 120 / 90 - 120 | 140 - 140 / 140 - 140 | 140 - 140 / 140 - 140 | 140 - 140 / 140 - 140 | 140 - 140 / 140 - 140 | 140 - 140 / 140 - 140 |
| <b>INTERNAL HEAT EXCHANGER</b> |         |                             |                   |                     |                       |                       |                       |                       |                       |
| Number                         |         | 1                           |                   |                     |                       |                       |                       |                       |                       |
| Type                           |         | Plates                      |                   |                     |                       |                       |                       |                       |                       |
| SUMMER OPERATION               |         |                             |                   |                     |                       |                       |                       |                       |                       |
| Water flow rate                | l/s     | 7,22                        | 8,44              | 9,8                 | 10,8                  | 12,6                  | 14,0                  | 15,9                  | 17,7                  |
| Water pressure drop            | kPa     | 25,5                        | 25,0              | 30,3                | 34,2                  | 18,3                  | 22,2                  | 17,2                  | 17,7                  |
| WINTER OPERATION               |         |                             |                   |                     |                       |                       |                       |                       |                       |
| Water flow rate                | l/s     | 8,10                        | 9,57              | 11,0                | 12,2                  | 14,1                  | 15,8                  | 18,0                  | 20,0                  |
| Water pressure drop            | kPa     | 31,6                        | 31,7              | 37,9                | 43,2                  | 22,6                  | 28,0                  | 21,6                  | 22,1                  |
| <b>WATER CONNECTIONS</b>       |         |                             |                   |                     |                       |                       |                       |                       |                       |
| Type                           |         | Victaulic                   |                   |                     |                       |                       |                       |                       |                       |
| Inlet diameter                 | inch    | 2"1/2                       | 2"1/2             | 2"1/2               | 2"1/2                 | 4"                    | 4"                    | 4"                    | 4"                    |
| Outlet diameter                | inch    | 2"1/2                       | 2"1/2             | 2"1/2               | 2"1/2                 | 4"                    | 4"                    | 4"                    | 4"                    |
| <b>EXTERNAL HEAT EXCHANGER</b> |         |                             |                   |                     |                       |                       |                       |                       |                       |
| Number                         |         | 1                           |                   |                     |                       |                       |                       |                       |                       |
| Type                           |         | Plates                      |                   |                     |                       |                       |                       |                       |                       |
| SUMMER OPERATION               |         |                             |                   |                     |                       |                       |                       |                       |                       |
| Water flow rate                | l/s     | 8,83                        | 10,42             | 12,0                | 13,3                  | 15,4                  | 17,1                  | 19,5                  | 21,7                  |
| Water pressure drop            | kPa     | 37,1                        | 37,2              | 44,6                | 50,9                  | 23,3                  | 18,3                  | 21,0                  | 20,9                  |
| WINTER OPERATION               |         |                             |                   |                     |                       |                       |                       |                       |                       |
| Water flow rate                | l/s     | 10,3                        | 12,0              | 13,9                | 15,3                  | 17,8                  | 20,0                  | 22,7                  | 25,2                  |
| Water pressure drop            | kPa     | 48,9                        | 48,5              | 58,8                | 66,5                  | 30,7                  | 24,6                  | 28,1                  | 27,6                  |
| <b>WATER CONNECTIONS</b>       |         |                             |                   |                     |                       |                       |                       |                       |                       |
| Type                           |         | Victaulic                   |                   |                     |                       |                       |                       |                       |                       |
| Inlet diameter                 | inch    | 2"1/2                       | 2"1/2             | 2"1/2               | 2"1/2                 | 4"                    | 4"                    | 4"                    | 4"                    |
| Outlet diameter                | inch    | 2"1/2                       | 2"1/2             | 2"1/2               | 2"1/2                 | 4"                    | 4"                    | 4"                    | 4"                    |
| <b>DESUPERHEATER</b>           |         |                             |                   |                     |                       |                       |                       |                       |                       |
| Number                         |         | 2                           |                   |                     |                       |                       |                       |                       |                       |
| Type                           |         | Plates                      |                   |                     |                       |                       |                       |                       |                       |
| Water flow rate                | l/s     | 1,05                        | 1,35              | 1,73                | 2,01                  | 2,41                  | 3,26                  | 3,73                  | 3,91                  |
| Water pressure drop            | kPa     | 8,3                         | 4,5               | 5,1                 | 5,7                   | 5,0                   | 8,7                   | 10,3                  | 7,5                   |
| <b>WATER CONNECTIONS</b>       |         |                             |                   |                     |                       |                       |                       |                       |                       |
| Type                           |         | GAS THREADED MALE CONNECTOR |                   |                     |                       |                       |                       |                       |                       |
| Inlet diameter                 | inch    | 1"                          | 1"                | 1"                  | 1"                    | 1"                    | 1"                    | 1"                    | 1"                    |
| Outlet diameter                | inch    | 1"                          | 1"                | 1"                  | 1"                    | 1"                    | 1"                    | 1"                    | 1"                    |
| <b>WEIGHT</b>                  |         |                             |                   |                     |                       |                       |                       |                       |                       |
| Shipping weight (1)            | kg      | 876                         | 947               | 1141                | 1311                  | 1302                  | 1410                  | 1494                  | 1585                  |
| Shipping weight (2)            | kg      | 979                         | 1050              | 1244                | 1414                  | 1405                  | 1513                  | 1597                  | 1688                  |

## 8 - Technical Data (continued)

|                      |    |  |      |      |      |      |      |      |      |
|----------------------|----|--|------|------|------|------|------|------|------|
| Operating weight (1) | kg | 909  | 989  | 1187 | 1360 | 1376 | 1500 | 1598 | 1704 |
| Operating weight (2) | kg | 1012   | 1092 | 1290 | 1463 | 1479 | 1603 | 1701 | 1807 |
| <b>DIMENSIONS</b>    |    |  |      |      |      |      |      |      |      |
| Length               | mm | 2250   |      |      |      |      |      |      |      |
| Width                | mm | 850 (1) / 854 (2) - 885 (1)/(3) - 1005 (2)/(3) |      |      |      |      |      |      |      |
| Height               | mm | 1845 (1) / 1850 (2)                            |      |      |      |      |      |      |      |

- (1) BLN VERSION  
(2) ELN VERSION  
(3) ONLY FOR HANDLING

| <b>WQRC 524-1204</b>                            |         | <b>524</b>                                     | <b>604</b>     | <b>704</b>     | <b>804</b>      | <b>904</b>      | <b>1004</b>     | <b>1104</b>     | <b>1204</b>     |
|---|---------|--|----------------|----------------|-----------------|-----------------|-----------------|-----------------|-----------------|
| Circuits number                                 |         | 2  |                |                |                 |                 |                 |                 |                 |
| Part load steps                                 | %       | 0-25-50-75-100                                 | 0-25-50-75-100 | 0-21-50-71-100 | 0-25-50-75-100  | 0-22-50-72-100  | 0-25-50-75-100  | 0-23-50-73-100  | 0-25-50-75-100  |
| Power supply                                    | V/ph/Hz | 400V/3/50Hz                                    | 400V/3/50Hz    | 400V/3/50Hz    | 400V/3/50Hz     | 400V/3/50Hz     | 400V/3/50Hz     | 400V/3/50Hz     | 400V/3/50Hz     |
| Startup type                                    |         | Direct   |                |                |                 |                 |                 |                 |                 |
| <b>REFRIGERANT</b>                              |         |  |                |                |                 |                 |                 |                 |                 |
| Type  |         | R410A  |                |                |                 |                 |                 |                 |                 |
| <b>COMPRESSORS</b>                              |         |  |                |                |                 |                 |                 |                 |                 |
| Number  |         | 2 / 2  |                |                |                 |                 |                 |                 |                 |
| Type  |         | Scroll   |                |                |                 |                 |                 |                 |                 |
| Oil carter resistance                           | W       | 90-90/90-90                                    | 90-90/90-90    | 90-120/90-120  | 140-140/140-140 | 140-140/140-140 | 140-140/140-140 | 140-140/140-140 | 140-140/140-140 |
| <b>EVAPORATOR</b>                               |         |  |                |                |                 |                 |                 |                 |                 |
| Number  |         | 1  |                |                |                 |                 |                 |                 |                 |
| Type  |         | Plates   |                |                |                 |                 |                 |                 |                 |
| Water flow rate                                 | l/s     | 6,21   | 7,42           | 8,5            | 9,4             | 10,7            | 11,8            | 13,7            | 15,1            |
| Pressure drop                                   | kPa     | 19,3   | 19,6           | 23,0           | 26,2            | 13,5            | 16,2            | 12,9            | 13,0            |
| <b>WATER CONNECTIONS</b>                        |         |  |                |                |                 |                 |                 |                 |                 |
| Type  |         | Victaulic                                      |                |                |                 |                 |                 |                 |                 |
| Inlet diameter                                  | inch    | 2"1/2  | 2"1/2          | 2"1/2          | 2"1/2           | 4"              | 4"              | 4"              | 4"              |
| Outlet diameter                                 | inch    | 2"1/2  | 2"1/2          | 2"1/2          | 2"1/2           | 4"              | 4"              | 4"              | 4"              |
| <b>REMOTE CONDENSER REFRIGERANT CONNECTIONS</b> |         |  |                |                |                 |                 |                 |                 |                 |
| Type  |         | To be welded                                   |                |                |                 |                 |                 |                 |                 |
| Inlet diameter                                  | inch    | 7/8"   | 7/8"           | 1 1/8"         | 1 1/8"          | 1 1/8"          | 1 1/8"          | 1 1/8"          | 1 1/8"          |
| Outlet diameter                                 | inch    | 1 1/8"   | 1 1/8"         | 1 3/8"         | 1 3/8"          | 1 5/8"          | 1 5/8"          | 1 5/8"          | 1 5/8"          |
| <b>WEIGHT</b>                                   |         |  |                |                |                 |                 |                 |                 |                 |
| Shipping weight (1)                             | kg      | 754  | 791            | 965            | 1138            | 1153            | 1203            | 1279            | 1333            |
| Shipping weight (2)                             | kg      | 857  | 894            | 1068           | 1241            | 1256            | 1306            | 1382            | 1436            |
| Operating weight (1)                            | kg      | 770  | 812            | 988            | 1163            | 1188            | 1241            | 1328            | 1388            |
| Operating weight (2)                            | kg      | 873  | 915            | 1091           | 1266            | 1291            | 1344            | 1431            | 1491            |
| <b>DIMENSIONS</b>                               |         |  |                |                |                 |                 |                 |                 |                 |
| Length  | mm      | 2250   |                |                |                 |                 |                 |                 |                 |
| Width   | mm      | 850 (1) / 854 (2) - 885 (1)/(3) - 1005 (2)/(3) |                |                |                 |                 |                 |                 |                 |
| Height  | mm      | 1845 (1) / 1850 (2)                            |                |                |                 |                 |                 |                 |                 |

- (1) BLN VERSION  
(2) ELN VERSION  
(3) ONLY FOR HANDLING

## 8 - Technical Data (continued)

### 8.3 Unit electrical data

| WQL/WQH/WQRC              |                 | 524                  | 604  | 704  | 804   | 904   | 1004  | 1104  | 1204  |
|---------------------------|-----------------|----------------------|------|------|-------|-------|-------|-------|-------|
| Rated voltage             | V/ph/Hz         | 400 (± 10%) / 3 / 50 |      |      |       |       |       |       |       |
| Max. absorbed power       | kW              | 59,0                 | 68,2 | 79,3 | 100,0 | 111,0 | 122,0 | 137,0 | 152,0 |
| Rated current             | A               | 64                   | 83   | 89   | 93    | 101   | 108   | 124   | 140   |
| Max. current FLA          | A               | 124                  | 136  | 148  | 176   | 194   | 212   | 238   | 264   |
| Max. start-up current LRA | A               | 233                  | 276  | 333  | 342   | 351   | 369   | 459   | 485   |
| External fuses            | A               | 160                  | 160  | 200  | 250   | 250   | 250   | 315   | 315   |
| Max. cable section (*)    | mm <sup>2</sup> | 95                   | 95   | 95   | 120   | 120   | 120   | 185   | 185   |

(\*) The dimensioning of the unit's power cables is the responsibility of the installer, who shall consider: the rating, the maximum working temperature in the room, the type of insulation and the cable laying, the maximum length of the power supply line.

### Compressors electrical data

| WQL/WQH/WQRC        |    | 524      | 604      | 704             | 804      | 904             | 1004     | 1104            | 1204     |
|---------------------|----|----------|----------|-----------------|----------|-----------------|----------|-----------------|----------|
| Number              | -  | 4        | 4        | 4               | 4        | 4               | 4        | 4               | 4        |
| Nominal power input | kW | 4 x 8,3  | 4 x 10,1 | 2x10,1 + 2x13,1 | 4 x 13,8 | 2x13,8 + 2x16,6 | 4 x 16,6 | 2x16,6 + 2x21,1 | 4 x 21,1 |
| Max. absorbed power | kW | 4 x 14,8 | 4 x 17,1 | 2x17,1 + 2x22,6 | 4 x 25,0 | 2x25,0 + 2x30,5 | 4 x 30,5 | 2x30,5 + 2x38,0 | 4 x 38,0 |
| Rated current       | A  | 4 x 16,0 | 4 x 20,7 | 2x20,7 + 2x23,9 | 4 x 23,2 | 2x23,2 + 2x27,1 | 4 x 27,1 | 2x27,1 + 2x35,1 | 4 x 35,1 |
| Max. current        | A  | 4 x 31   | 4 x 34   | 2x34 + 2x40     | 4 x 44   | 2x44 + 2x53     | 4 x 53   | 2x53 + 2x66     | 4 x 66   |
| Oil pan resistor    | W  | 4 x 90   | 4 x 90   | 2x90 + 2x120    | 4 x 140  | 4 x 140         | 4 x 140  | 4 x 140         | 4 x 140  |

### Pumps electrical data

| WQL/WQH/WQRC -2P/SP evaporator |         | 524                  | 604 | 704 | 804 | 904 | 1004 | 1104 | 1204 |
|--------------------------------|---------|----------------------|-----|-----|-----|-----|------|------|------|
| Rated voltage                  | V/ph/Hz | 400 (± 10%) / 3 / 50 |     |     |     |     |      |      |      |
| Rated power                    | kW      | 2,2                  | 2,2 | 2,2 | 3,0 | 3,0 | 3,0  | 4,0  | 4,0  |
| Absorbed rated current FLA     | A       | 5,0                  | 5,0 | 5,0 | 6,3 | 6,3 | 6,3  | 7,7  | 7,7  |

| WQL/WQH -2P/SP condenser   |         | 524                  | 604 | 704 | 804 | 904 | 1004 | 1104 | 1204 |
|----------------------------|---------|----------------------|-----|-----|-----|-----|------|------|------|
| Rated voltage              | V/ph/Hz | 400 (± 10%) / 3 / 50 |     |     |     |     |      |      |      |
| Rated power                | kW      | 2,2                  | 3,0 | 3,0 | 4,0 | 4,0 | 5,5  | 5,5  | 5,5  |
| Absorbed rated current FLA | A       | 5,0                  | 6,3 | 6,3 | 7,7 | 7,7 | 10,4 | 10,4 | 10,4 |

| WQL/WQH/WQRC -2P/HP evaporator |         | 524                  | 604 | 704 | 804 | 904  | 1004 | 1104 | 1204 |
|--------------------------------|---------|----------------------|-----|-----|-----|------|------|------|------|
| Rated voltage                  | V/ph/Hz | 400 (± 10%) / 3 / 50 |     |     |     |      |      |      |      |
| Rated power                    | kW      | 3,0                  | 3,0 | 4,0 | 4,0 | 5,5  | 5,5  | 5,5  | 7,5  |
| Absorbed rated current FLA     | A       | 6,3                  | 6,3 | 7,7 | 7,7 | 10,4 | 10,4 | 10,4 | 13,9 |

| WQL/WQH -2P/HP condenser   |         | 524                  | 604 | 704 | 804 | 904  | 1004 | 1104 | 1204 |
|----------------------------|---------|----------------------|-----|-----|-----|------|------|------|------|
| Rated voltage              | V/ph/Hz | 400 (± 10%) / 3 / 50 |     |     |     |      |      |      |      |
| Rated power                | kW      | 3,0                  | 3,0 | 4,0 | 4,0 | 5,5  | 5,5  | 5,5  | 7,5  |
| Absorbed rated current FLA | A       | 6,3                  | 6,3 | 7,7 | 7,7 | 10,4 | 10,4 | 10,4 | 13,9 |

## 8 - Technical Data (continued)

**WQL/H/RC 524-1204 available static pressure - internal heat exchanger (1/2P SP/E)**

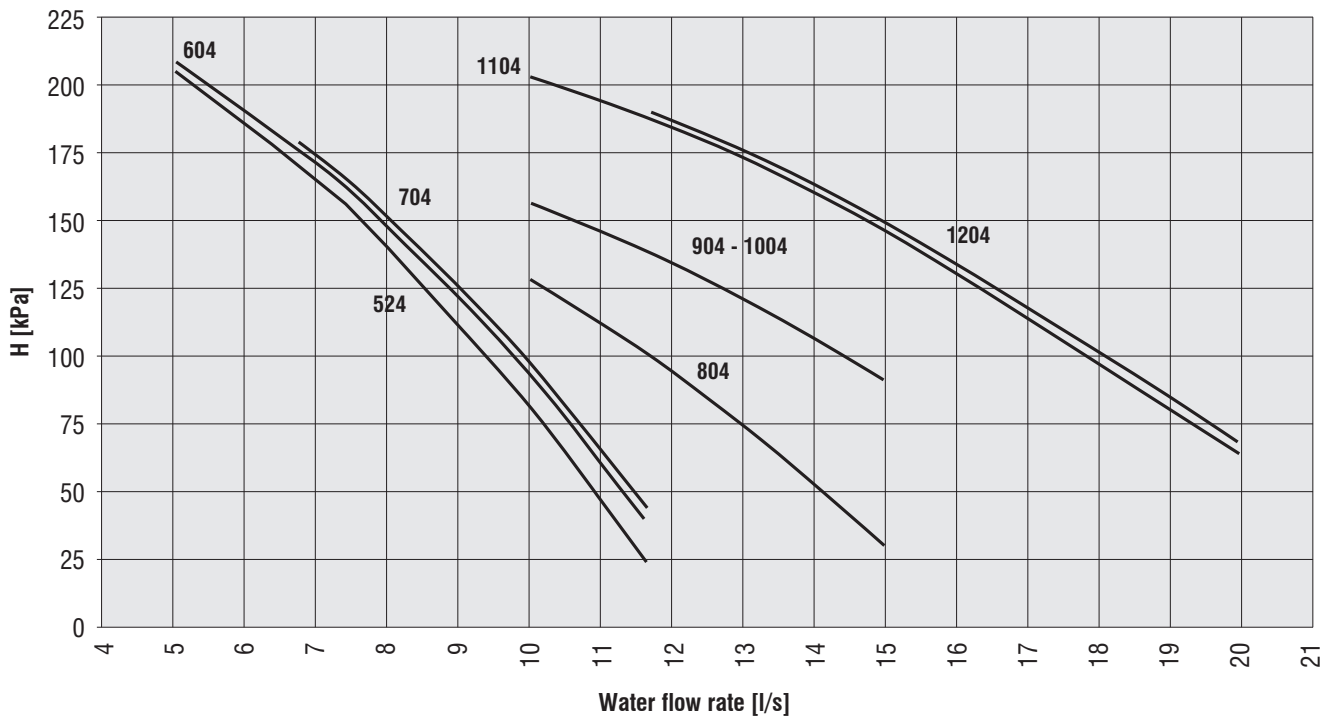

**WQL/H 524-1204 available static pressure - external heat exchanger (1/2P SP/C)**

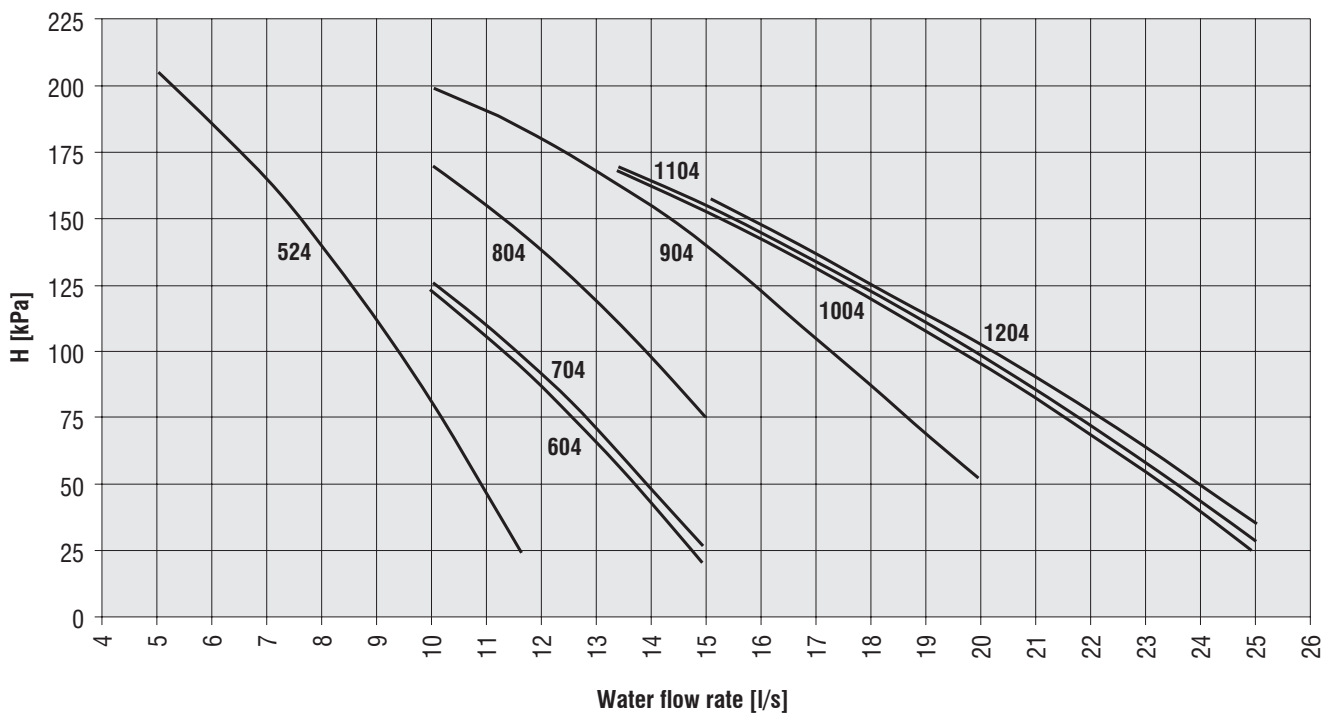

## 8 - Technical Data (continued)

WQL/H/RC 50-190 available static pressure - internal heat exchanger (1/2P HP/E)

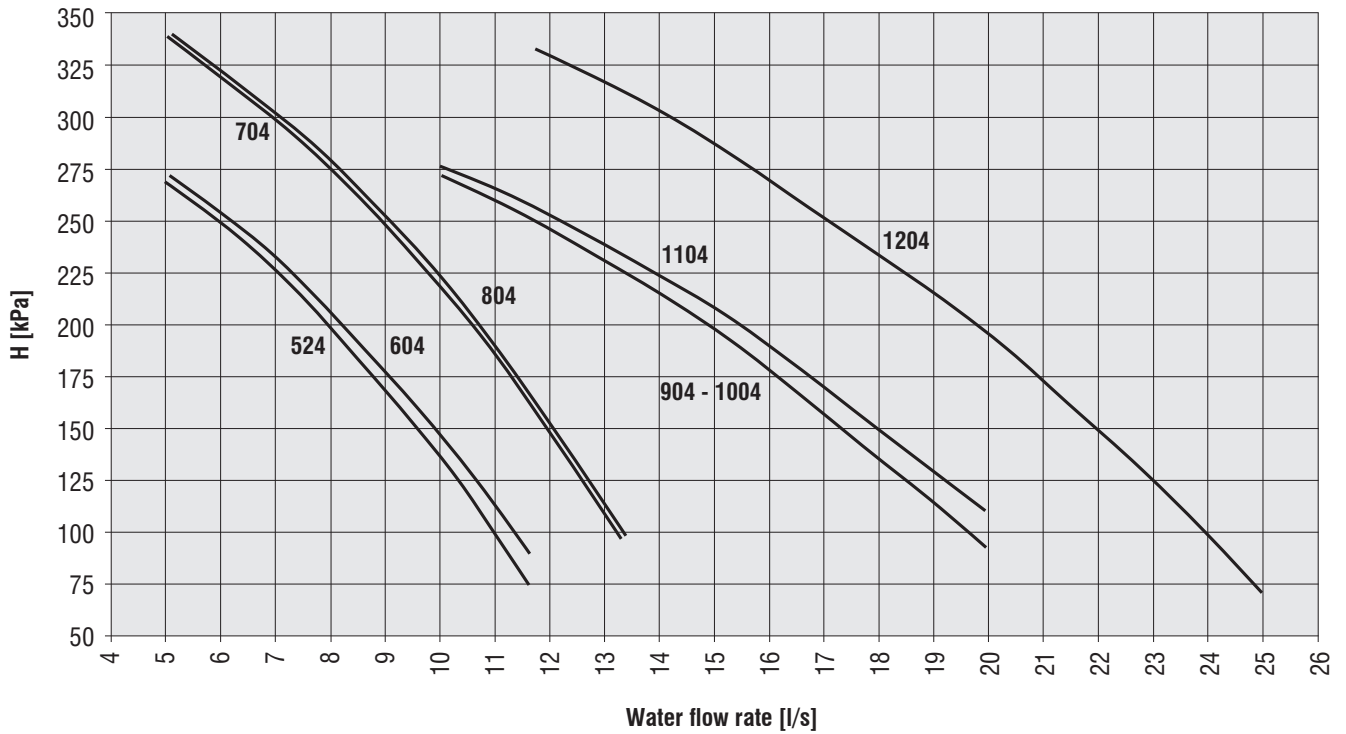

WQL/H 50-190 available static pressure - external heat exchanger (1/2P HP/C)

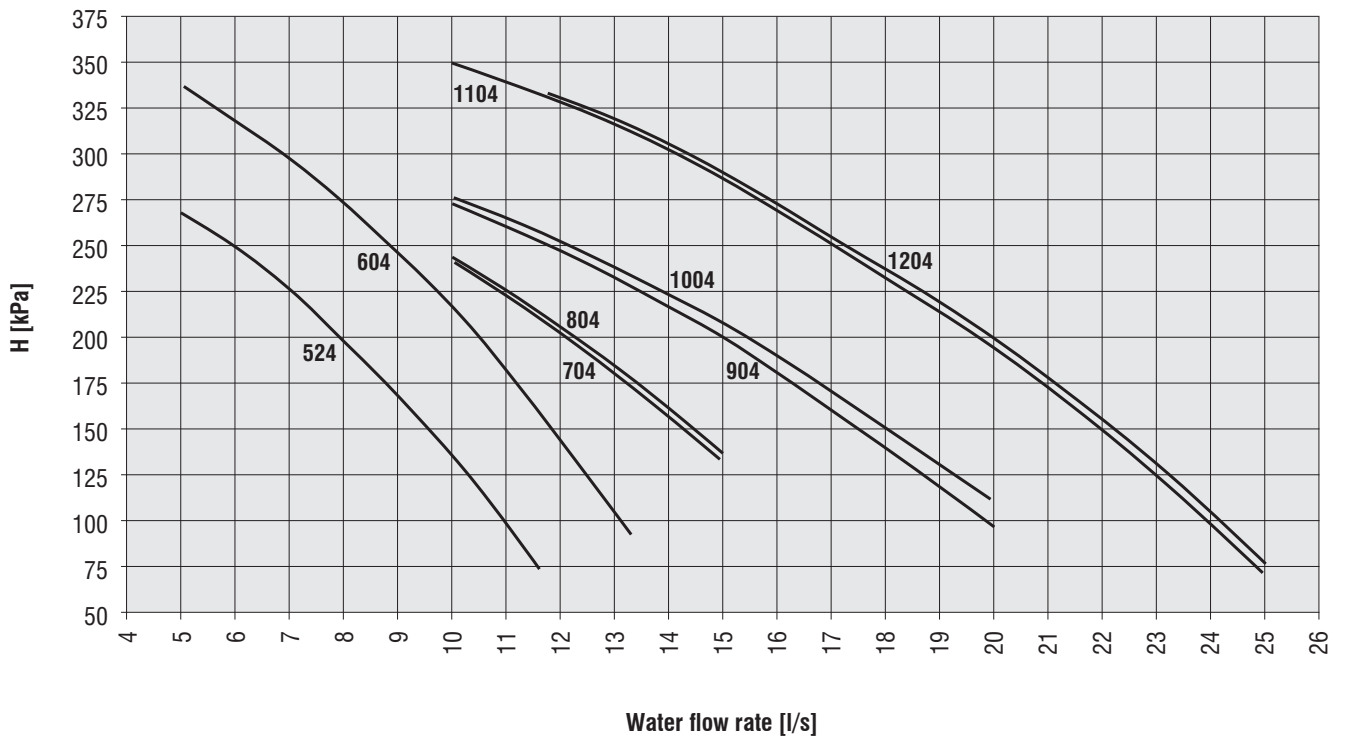

## 8 - Technical Data (continued)

### WQL/H/RC 524-1204 - available static pressure - internal heat exchanger

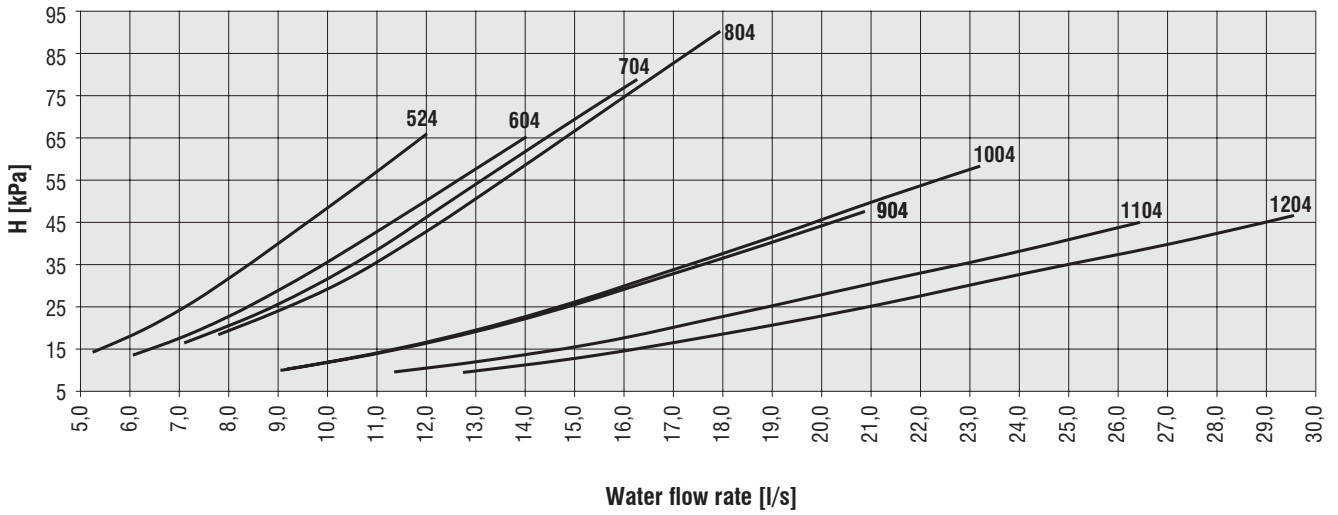

### WQL/H 524-1204 - available static pressure - external heat exchanger

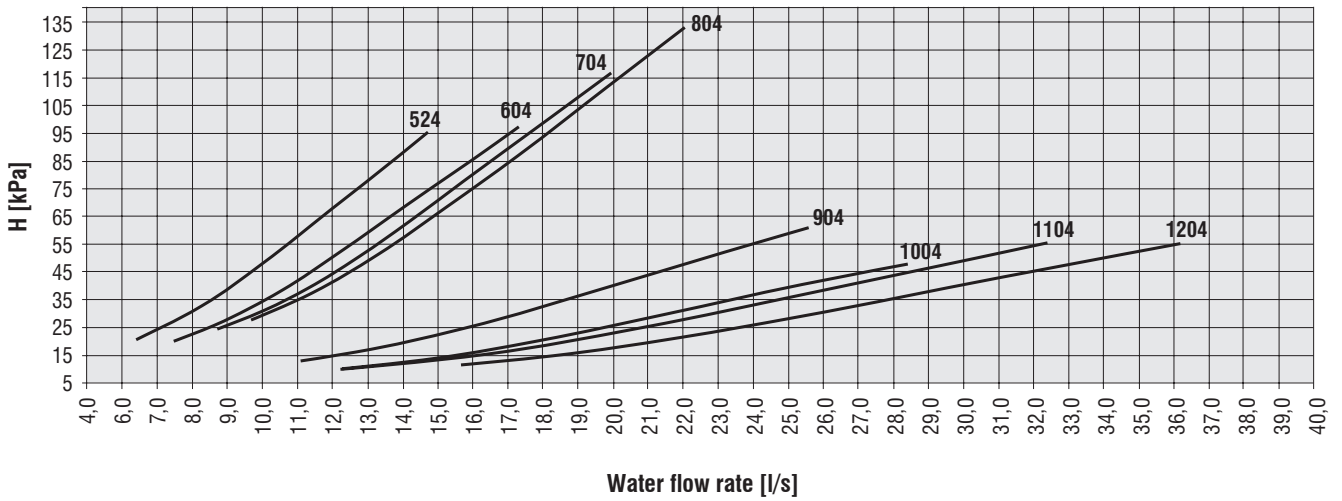

## 8 - Technical Data (continued)

### WQL/H/RC 524-1204 - desuperheater pressure drop

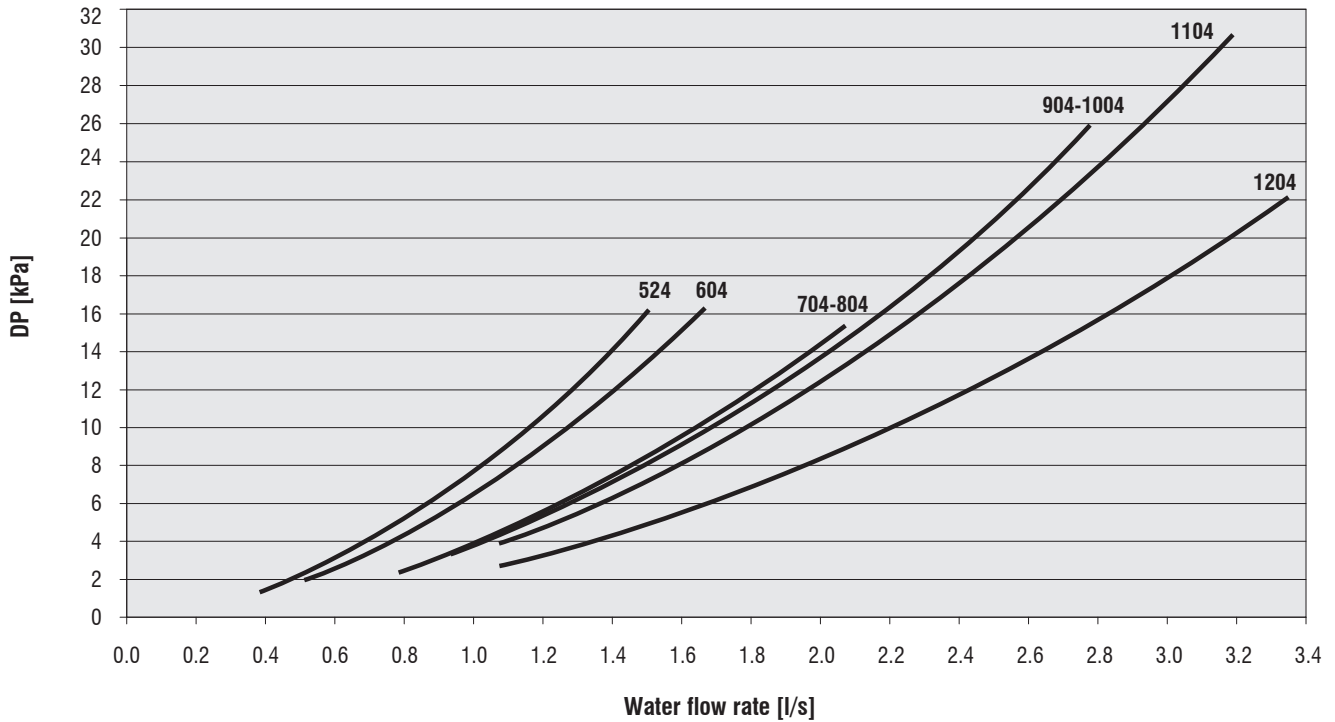

|      | WQL/WQH/WQRC<br>524-1204<br>(BLN) | Weight distribution (kg) |     |     |      | Operating<br>weight (kg) | Shipping<br>weight (kg) | P1-P4 coordinates |        | CG coordinates |        |
|------|-----------------------------------|--------------------------|-----|-----|------|--------------------------|-------------------------|-------------------|--------|----------------|--------|
|      |                                   | P1                       | P2  | P3  | P4   |                          |                         | a (mm)            | b (mm) | x (mm)         | y (mm) |
|      | 524                               | 248                      | 265 | 180 | 198  | 890                      | 858                     | 774               | 1100   | 441            | 1059   |
|      | 604                               | 247                      | 279 | 206 | 239  | 971                      | 929                     | 774               | 1100   | 451            | 1021   |
|      | 704                               | 300                      | 312 | 266 | 278  | 1156                     | 1110                    | 774               | 1100   | 433            | 1008   |
|      | 804                               | 384                      | 372 | 293 | 280  | 1329                     | 1279                    | 774               | 1100   | 418            | 1051   |
|      | 904                               | 409                      | 383 | 287 | 260  | 1340                     | 1266                    | 774               | 1100   | 410            | 1076   |
|      | 1004                              | 429                      | 411 | 316 | 298  | 1453                     | 1363                    | 774               | 1100   | 415            | 1061   |
|      | 1104                              | 448                      | 437 | 339 | 328  | 1552                     | 1449                    | 774               | 1100   | 419            | 1052   |
|      | 1204                              | 473                      | 471 | 359 | 357  | 1660                     | 1541                    | 774               | 1100   | 424            | 1050   |
|      | 524                               | 252                      | 275 | 179 | 203  | 909                      | 876                     | 774               | 1100   | 445            | 1063   |
|      | 604                               | 251                      | 289 | 206 | 244  | 989                      | 947                     | 774               | 1100   | 455            | 1025   |
|      | 704                               | 307                      | 328 | 265 | 286  | 1187                     | 1141                    | 774               | 1100   | 439            | 1014   |
|      | 804                               | 392                      | 388 | 292 | 288  | 1360                     | 1311                    | 774               | 1100   | 423            | 1056   |
| 904  | 418                               | 402                      | 286 | 270 | 1376 | 1302                     | 774                     | 1100              | 416    | 1080           |        |
| 1004 | 440                               | 435                      | 315 | 310 | 1500 | 1410                     | 774                     | 1100              | 423    | 1067           |        |
| 1104 | 459                               | 461                      | 338 | 340 | 1598 | 1494                     | 774                     | 1100              | 426    | 1058           |        |
| 1204 | 483                               | 494                      | 358 | 369 | 1704 | 1585                     | 774                     | 1100              | 430    | 1056           |        |
| 524  | 279                               | 272                      | 113 | 106 | 770  | 754                      | 774                     | 1100              | 417    | 1212           |        |
| 604  | 280                               | 278                      | 127 | 125 | 812  | 791                      | 774                     | 1100              | 423    | 1182           |        |
| 704  | 336                               | 312                      | 182 | 158 | 988  | 965                      | 774                     | 1100              | 407    | 1147           |        |
| 804  | 424                               | 377                      | 205 | 157 | 1163 | 1138                     | 774                     | 1100              | 394    | 1183           |        |
| 904  | 449                               | 391                      | 203 | 145 | 1188 | 1153                     | 774                     | 1100              | 387    | 1202           |        |
| 1004 | 469                               | 405                      | 215 | 152 | 1241 | 1203                     | 774                     | 1100              | 385    | 1199           |        |
| 1104 | 488                               | 429                      | 235 | 176 | 1328 | 1279                     | 774                     | 1100              | 391    | 1184           |        |
| 1204 | 506                               | 445                      | 249 | 188 | 1388 | 1333                     | 774                     | 1100              | 391    | 1179           |        |



## 8 - Technical Data (continued)

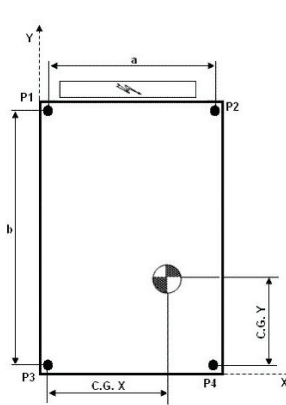

|             | WQL/WQH/WQRC<br>524-1204<br>(ELN) | Weight distribution (kg) |     |     |     | Operating<br>weight (kg) | Shipping<br>weight (kg) | P1-P4 coordinates |        | CG coordinates |        |
|-------------|-----------------------------------|--------------------------|-----|-----|-----|--------------------------|-------------------------|-------------------|--------|----------------|--------|
|             |                                   | P1                       | P2  | P3  | P4  |                          |                         | a (mm)            | b (mm) | x (mm)         | y (mm) |
| <b>WQL</b>  | <b>524</b>                        | 265                      | 284 | 213 | 232 | 993                      | 961                     | 774               | 1100   | 440            | 1033   |
|             | <b>604</b>                        | 264                      | 298 | 239 | 273 | 1074                     | 1032                    | 774               | 1100   | 449            | 1000   |
|             | <b>704</b>                        | 317                      | 331 | 299 | 312 | 1259                     | 1213                    | 774               | 1100   | 433            | 991    |
|             | <b>804</b>                        | 402                      | 390 | 326 | 314 | 1432                     | 1382                    | 774               | 1100   | 419            | 1034   |
|             | <b>904</b>                        | 427                      | 401 | 320 | 294 | 1443                     | 1369                    | 774               | 1100   | 411            | 1056   |
|             | <b>1004</b>                       | 446                      | 429 | 349 | 332 | 1556                     | 1466                    | 774               | 1100   | 416            | 1044   |
|             | <b>1104</b>                       | 466                      | 455 | 372 | 362 | 1655                     | 1552                    | 774               | 1100   | 420            | 1037   |
|             | <b>1204</b>                       | 491                      | 489 | 392 | 391 | 1763                     | 1644                    | 774               | 1100   | 424            | 1036   |
| <b>WQH</b>  | <b>524</b>                        | 269                      | 293 | 212 | 237 | 1012                     | 979                     | 774               | 1100   | 443            | 1037   |
|             | <b>604</b>                        | 268                      | 307 | 239 | 278 | 1092                     | 1050                    | 774               | 1100   | 452            | 1004   |
|             | <b>704</b>                        | 324                      | 347 | 298 | 320 | 1290                     | 1244                    | 774               | 1100   | 438            | 997    |
|             | <b>804</b>                        | 409                      | 407 | 325 | 322 | 1463                     | 1414                    | 774               | 1100   | 424            | 1038   |
|             | <b>904</b>                        | 435                      | 420 | 319 | 304 | 1479                     | 1405                    | 774               | 1100   | 417            | 1061   |
|             | <b>1004</b>                       | 457                      | 453 | 348 | 344 | 1603                     | 1513                    | 774               | 1100   | 423            | 1050   |
|             | <b>1104</b>                       | 476                      | 479 | 371 | 374 | 1701                     | 1597                    | 774               | 1100   | 426            | 1043   |
|             | <b>1204</b>                       | 501                      | 512 | 392 | 403 | 1807                     | 1688                    | 774               | 1100   | 430            | 1042   |
| <b>WQRC</b> | <b>524</b>                        | 297                      | 290 | 147 | 140 | 873                      | 857                     | 774               | 1100   | 419            | 1164   |
|             | <b>604</b>                        | 298                      | 297 | 161 | 159 | 915                      | 894                     | 774               | 1100   | 424            | 1140   |
|             | <b>704</b>                        | 353                      | 331 | 215 | 192 | 1091                     | 1068                    | 774               | 1100   | 409            | 1115   |
|             | <b>804</b>                        | 442                      | 395 | 238 | 191 | 1266                     | 1241                    | 774               | 1100   | 397            | 1152   |
|             | <b>904</b>                        | 466                      | 409 | 236 | 179 | 1291                     | 1256                    | 774               | 1100   | 391            | 1171   |
|             | <b>1004</b>                       | 486                      | 424 | 249 | 186 | 1344                     | 1306                    | 774               | 1100   | 389            | 1169   |
|             | <b>1104</b>                       | 505                      | 447 | 268 | 210 | 1431                     | 1382                    | 774               | 1100   | 394            | 1157   |
|             | <b>1204</b>                       | 524                      | 463 | 282 | 222 | 1491                     | 1436                    | 774               | 1100   | 394            | 1153   |

## 8 - Technical Data (continued)

### 8.6 Dimensional drawings - WQL/WQH 524-1204 BLN

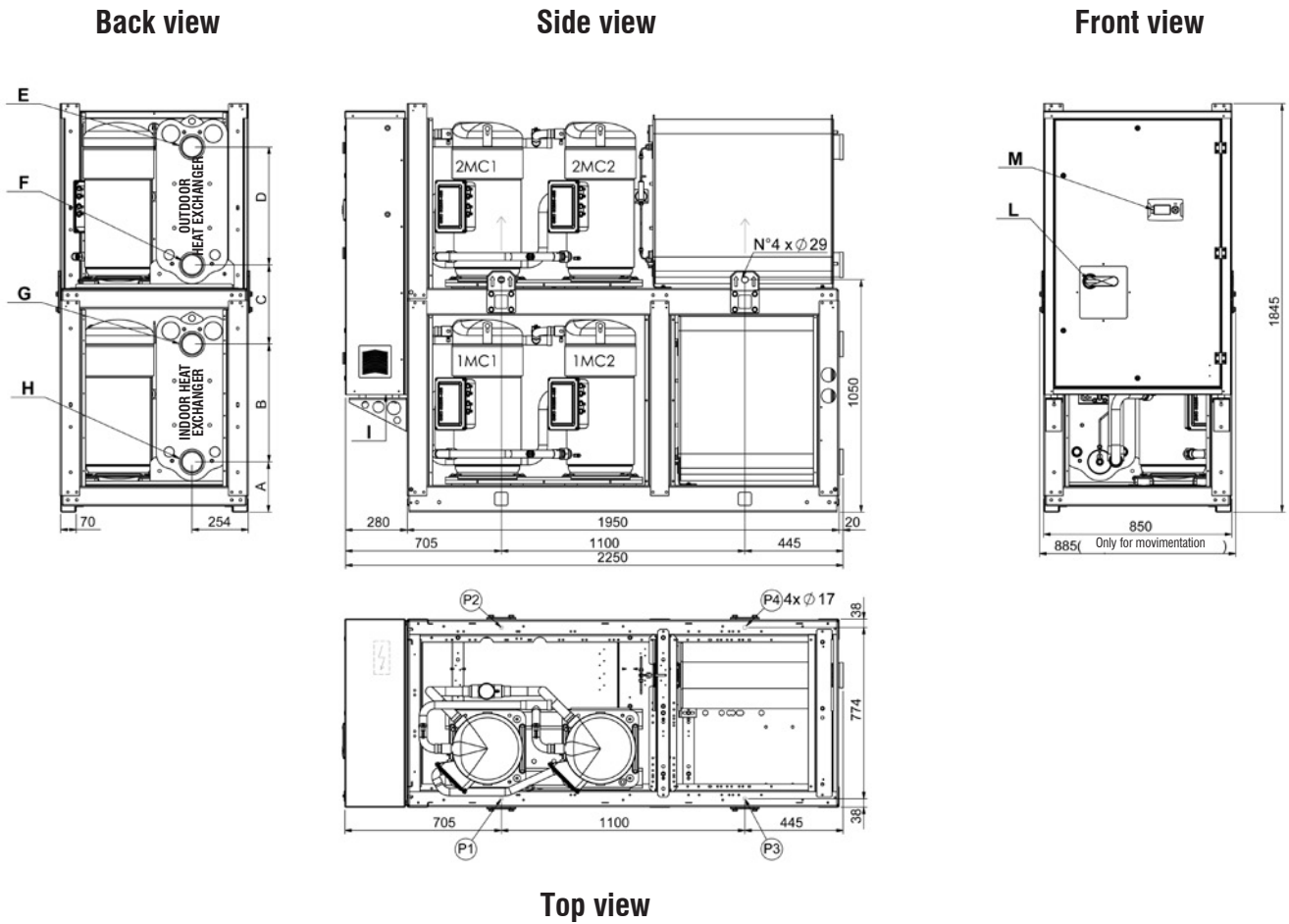

|                 | INDOOR HEAT EXCHANGER |            | OUTDOOR HEAT EXCHANGER |            |
|-----------------|-----------------------|------------|------------------------|------------|
|                 | IN<br>G               | OUT<br>H   | IN<br>E                | OUT<br>F   |
|                 | <b>DIMENSIONS</b>     |            |                        |            |
| <b>524-804</b>  | A = 227 mm            | B = 369 mm | C = 521 mm             | D = 369 mm |
|                 | 2 1/2" VICT - 76,1 mm |            |                        |            |
| <b>904-1204</b> | A = 227 mm            | B = 532 mm | C = 358 mm             | D = 532 mm |
|                 | 4" VICT - 114,3 mm    |            |                        |            |

## 8 - Technical Data (continued)

### Dimensional drawings - WQRC 524-1204 BLN

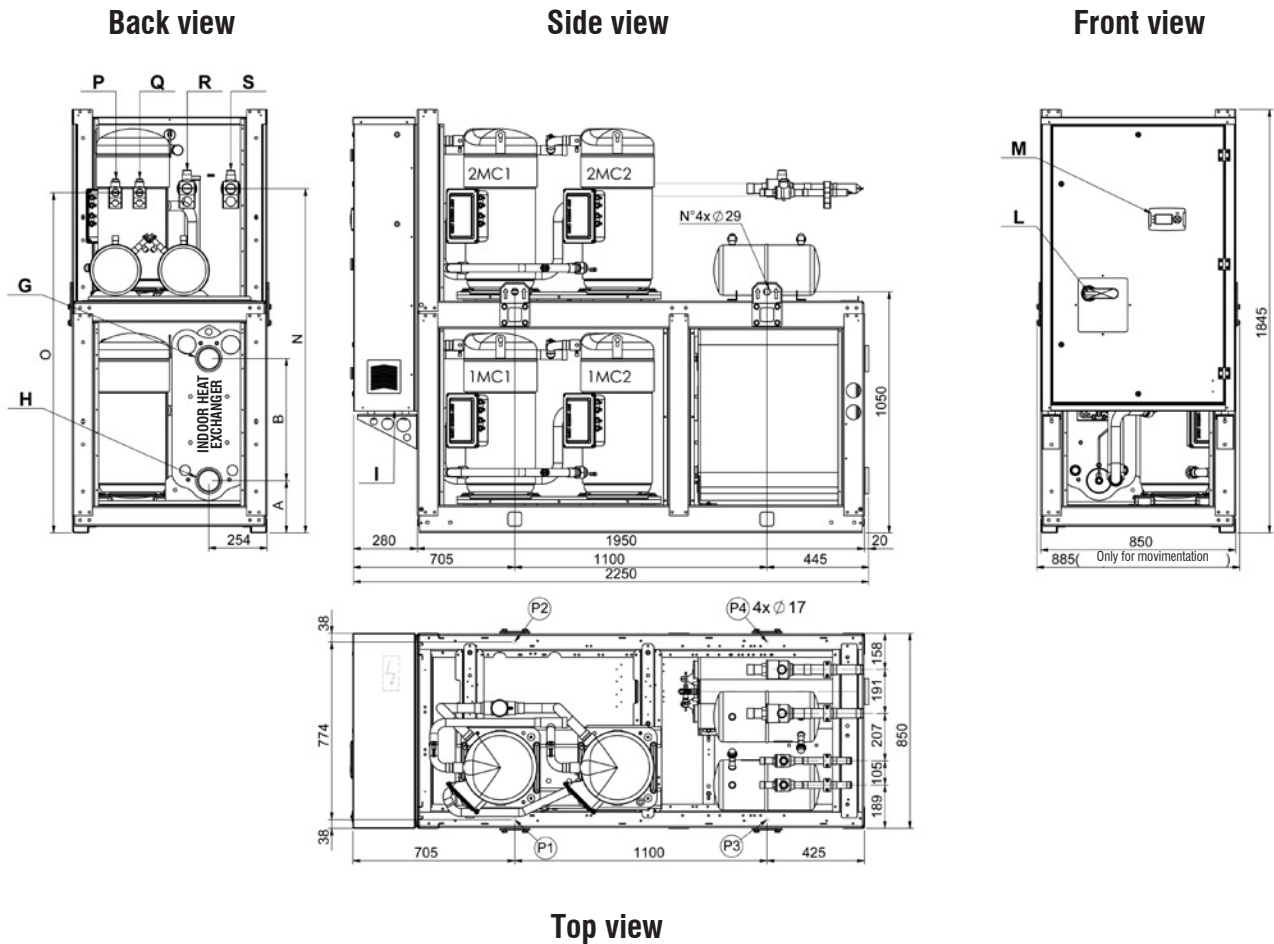

Top view

|          | INDOOR HEAT EXCHANGER |            |
|----------|-----------------------|------------|
|          | IN                    | OUT        |
|          | G                     | H          |
| 524-804  | DIMENSIONS            |            |
|          | A = 227 mm            | B = 369 mm |
|          | 2 1/2" VICT - 76,1 mm |            |
| 904-1204 | A = 227 mm            | B = 532 mm |
|          | 4" VICT - 114,3 mm    |            |

|            | LIQUID CONNECTION 2 | LIQUID CONNECTION 1 | DISCHARGE CONNECTION 1 | DISCHARGE CONNECTION 2 | N    | O    |
|------------|---------------------|---------------------|------------------------|------------------------|------|------|
|            | P                   | Q                   | R                      | S                      |      |      |
| DIMENSIONS |                     |                     |                        |                        |      |      |
| 904-1204   | 1 1/8"              | 1 1/8"              | 1 5/8"                 | 1 5/8"                 | 1500 | 1435 |
| 704-804    | 1 1/8"              | 1 1/8"              | 1 3/8"                 | 1 3/8"                 | 1500 | 1480 |
| 524-604    | 7/8"                | 7/8"                | 1 1/8"                 | 1 1/8"                 | 1435 | 1435 |

## 8 - Technical Data (continued)

### Dimensional drawings - WQL/WQH 524-1204 ELN

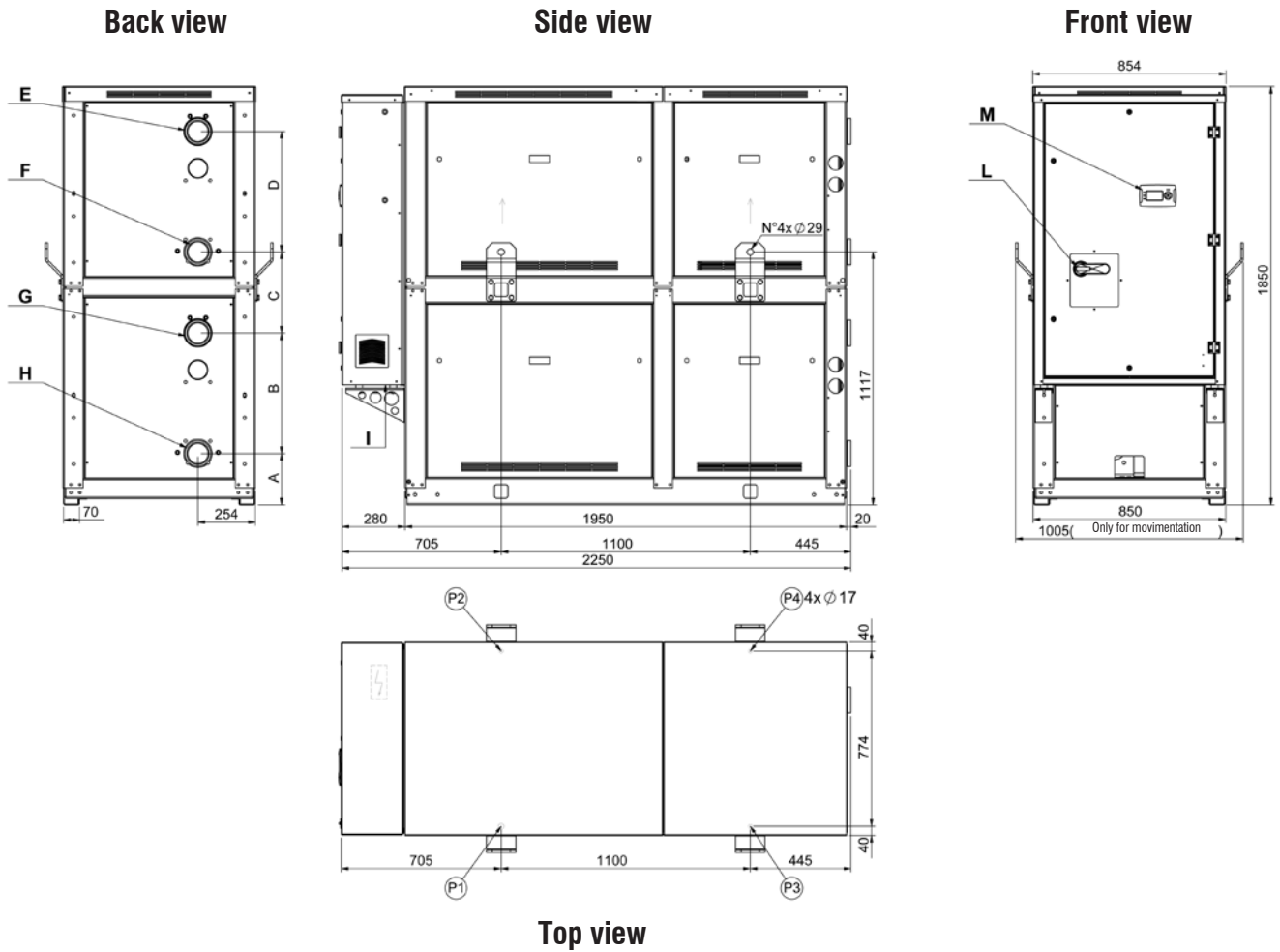

|                 | INDOOR HEAT EXCHANGER |            | OUTDOOR HEAT EXCHANGER |            |
|-----------------|-----------------------|------------|------------------------|------------|
|                 | IN<br>G               | OUT<br>H   | IN<br>E                | OUT<br>F   |
|                 | <b>DIMENSIONS</b>     |            |                        |            |
| <b>524-804</b>  | A = 227 mm            | B = 369 mm | C = 521 mm             | D = 369 mm |
|                 | 2 1/2" VICT - 76,1 mm |            |                        |            |
| <b>904-1204</b> | A = 227 mm            | B = 532 mm | C = 358 mm             | D = 532 mm |
|                 | 4" VICT - 114,3 mm    |            |                        |            |

## 8 - Technical Data (continued)

### Dimensional drawings - WQRC 524-1204 ELN

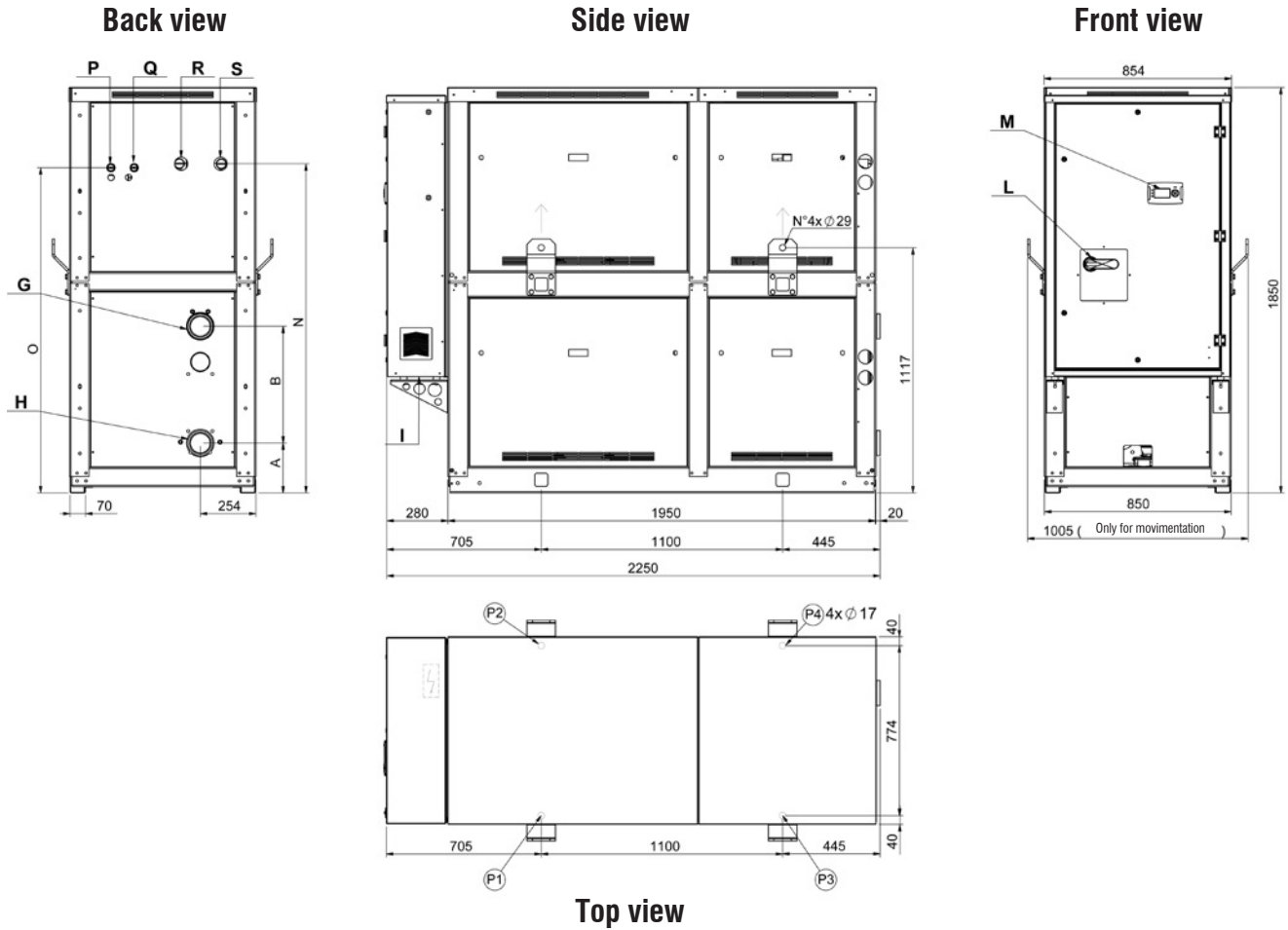

|                 | INDOOR HEAT EXCHANGER |            |
|-----------------|-----------------------|------------|
|                 | IN                    | OUT        |
|                 | G                     | H          |
|                 | DIMENSIONS            |            |
| <b>524-804</b>  | A = 227 mm            | B = 369 mm |
|                 | 2 1/2" VICT - 76,1 mm |            |
| <b>904-1204</b> | A = 227 mm            | B = 532 mm |
|                 | 4" VICT - 114,3 mm    |            |

## 8 - Technical Data (continued)

### Dimensional drawings - WQ + IDRO 524-1204

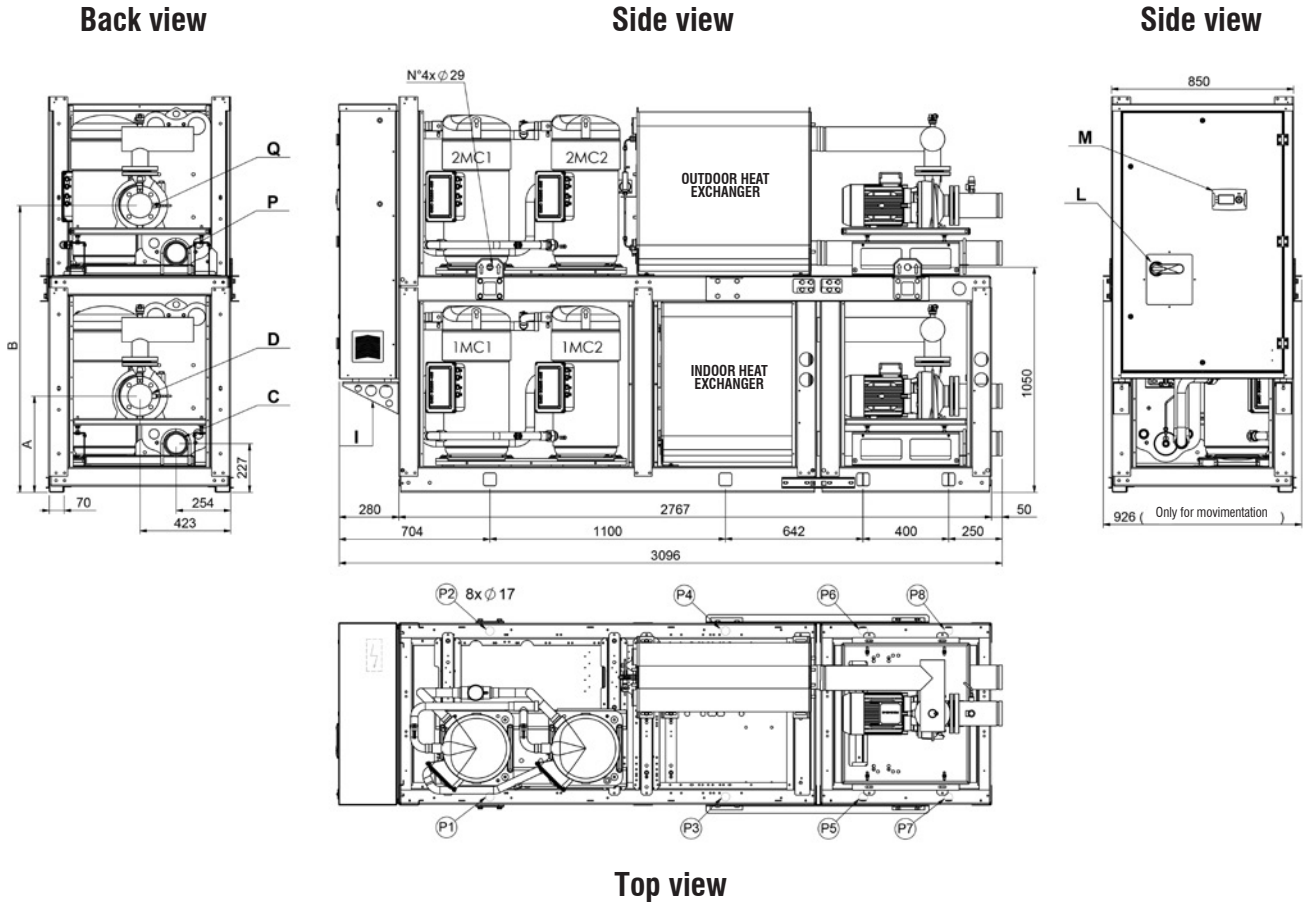

| 2P         | A   |     | B    |      |
|------------|-----|-----|------|------|
|            | LP  | HP  | LP   | HP   |
| Dimensions |     |     |      |      |
| 524        | 410 | 430 | 1300 | 1320 |
| 604        | 410 | 430 | 1320 | 1320 |
| 704        | 410 | 430 | 1320 | 1365 |
| 804        | 430 | 430 | 1320 | 1365 |
| 904        | 450 | 475 | 1340 | 1365 |
| 1004       | 450 | 475 | 1365 | 1365 |
| 1104       | 450 | 475 | 1365 | 1365 |
| 1204       | 450 | 475 | 1365 | 1365 |

| 1P         | A   |     | B    |      |
|------------|-----|-----|------|------|
|            | LP  | HP  | LP   | HP   |
| Dimensions |     |     |      |      |
| 524        | 410 | 430 | 1300 | 1320 |
| 604        | 410 | 430 | 1320 | 1320 |
| 704        | 410 | 430 | 1320 | 1330 |
| 804        | 430 | 430 | 1340 | 1330 |
| 904        | 450 | 440 | 1340 | 1330 |
| 1004       | 450 | 440 | 1365 | 1330 |
| 1104       | 450 | 440 | 1365 | 1330 |
| 1204       | 450 | 440 | 1365 | 1330 |

Low pressure pump (LP)  
High pressure pump (HP)

|          |         | WATER CONNECTIONS     |     |                        |     | WATER CONNECTIONS DIMENSIONS |
|----------|---------|-----------------------|-----|------------------------|-----|------------------------------|
|          |         | INDOOR HEAT EXCHANGER |     | OUTDOOR HEAT EXCHANGER |     |                              |
|          |         | IN                    | OUT | IN                     | OUT |                              |
|          |         | DIMENSIONS            |     |                        |     |                              |
| 524-804  | STD     | E                     | C   | R                      | P   | 2 1/2" VICT<br>76,1 mm       |
|          | 1P - 2P | D                     | C   | Q                      | P   |                              |
| 904-1204 | STD     | F                     | C   | S                      | P   | 4" VICT<br>114,3 mm          |
|          | 1P - 2P | D                     | C   | Q                      | P   |                              |

## 8 - Technical Data (continued)

### 8.6 Dimensional drawings - WQ + IDRO 524-1204

Back view

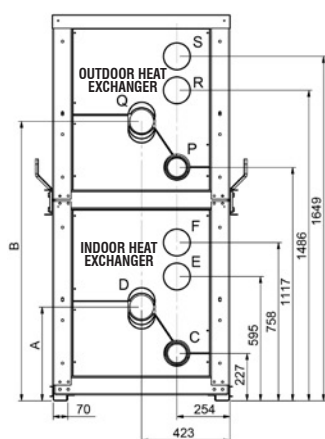

Side view

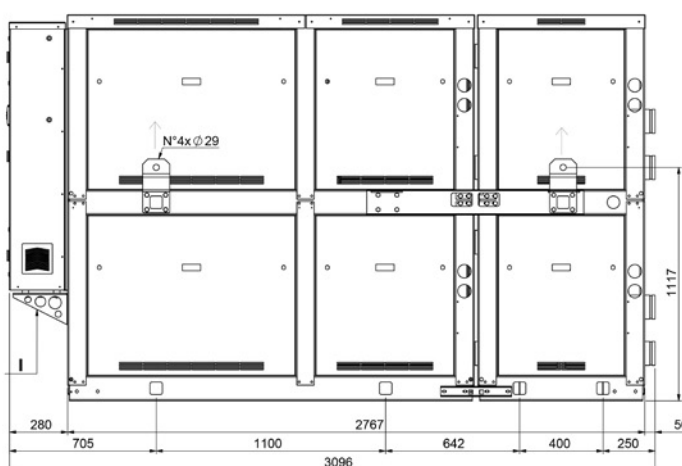

Front view

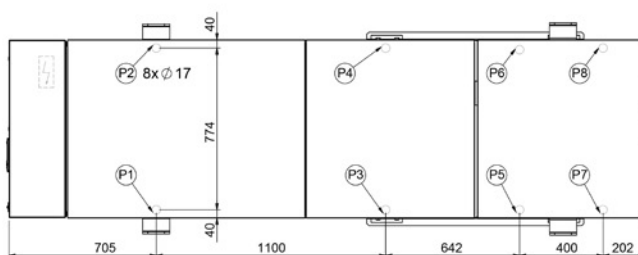
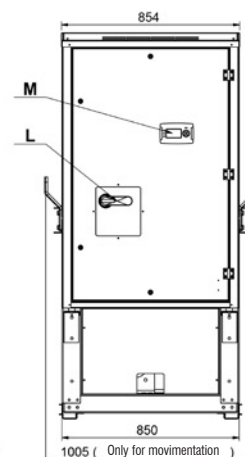

Top view

| 2P         | A   |     | B    |      |
|------------|-----|-----|------|------|
|            | LP  | HP  | LP   | HP   |
| Dimensions |     |     |      |      |
| 524        | 410 | 430 | 1300 | 1320 |
| 604        | 410 | 430 | 1320 | 1320 |
| 704        | 410 | 430 | 1320 | 1365 |
| 804        | 430 | 430 | 1320 | 1365 |
| 904        | 450 | 475 | 1340 | 1365 |
| 1004       | 450 | 475 | 1365 | 1365 |
| 1104       | 450 | 475 | 1365 | 1365 |
| 1204       | 450 | 475 | 1365 | 1365 |

| 1P         | A   |     | B    |      |
|------------|-----|-----|------|------|
|            | LP  | HP  | LP   | HP   |
| Dimensions |     |     |      |      |
| 524        | 410 | 430 | 1300 | 1320 |
| 604        | 410 | 430 | 1320 | 1320 |
| 704        | 410 | 430 | 1320 | 1330 |
| 804        | 430 | 430 | 1340 | 1330 |
| 904        | 450 | 440 | 1340 | 1330 |
| 1004       | 450 | 440 | 1365 | 1330 |
| 1104       | 450 | 440 | 1365 | 1330 |
| 1204       | 450 | 440 | 1365 | 1330 |

Low pressure pump (LP)  
High pressure pump (HP)

|          | WATER CONNECTIONS     |     |                        |     | WATER CONNECTIONS DIMENSIONS |                        |
|----------|-----------------------|-----|------------------------|-----|------------------------------|------------------------|
|          | INDOOR HEAT EXCHANGER |     | OUTDOOR HEAT EXCHANGER |     |                              |                        |
|          | IN                    | OUT | IN                     | OUT |                              |                        |
|          | DIMENSIONS            |     |                        |     |                              |                        |
| 524-804  | STD                   | E   | C                      | R   | P                            | 2 1/2" VICT<br>76,1 mm |
|          | 1P - 2P               | D   | C                      | Q   | P                            |                        |
| 904-1204 | STD                   | F   | C                      | S   | P                            | 4" VICT<br>114,3 mm    |
|          | 1P - 2P               | D   | C                      | Q   | P                            |                        |

## 8 - Technical Data (continued)

### 8.7 Unit clearances (in mm)

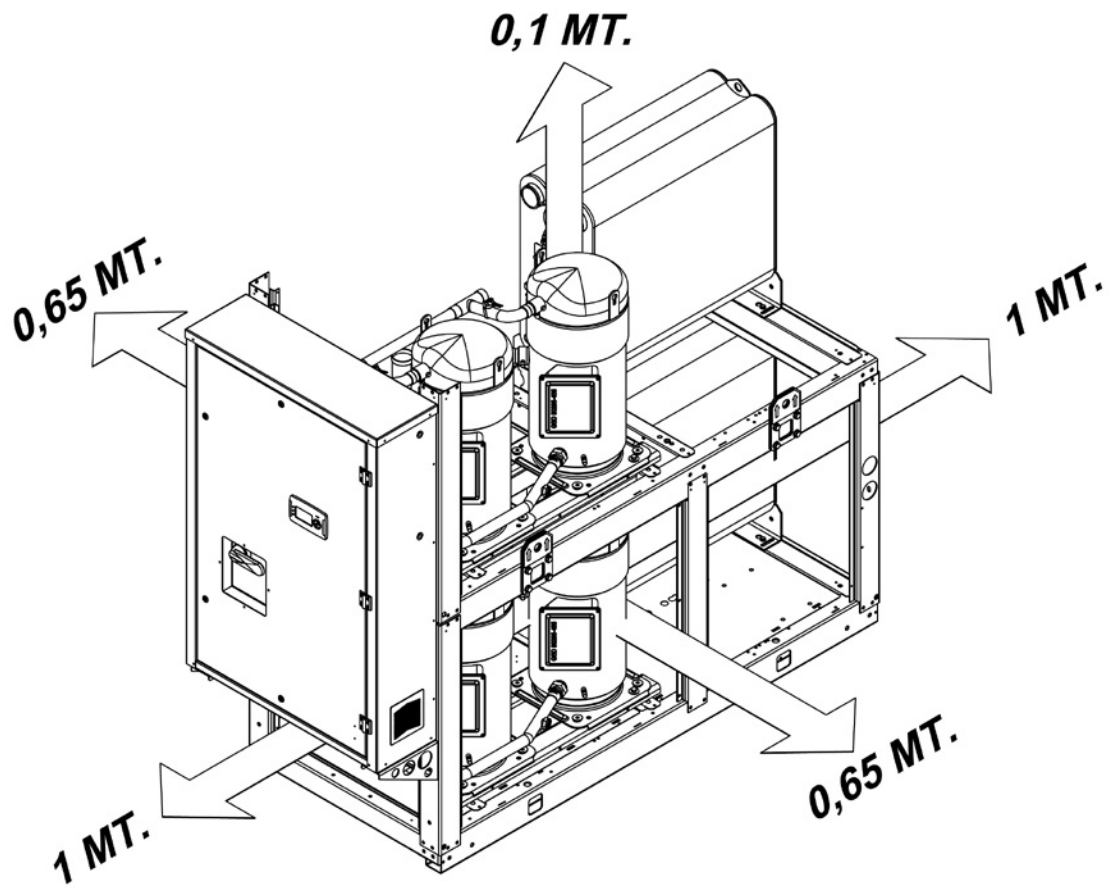



## 9 - Maintenance

Carefully read the “Safety” section of this manual before carrying out any maintenance operations.

|   |   |
|---|---|
|  | <p><b>Do not discharge the refrigerant into the atmosphere while the refrigeration circuits are being drained. Use appropriate recovery equipment.</b></p> <p><b>When the recovered refrigerant cannot be re-used, return it to the manufacturer.</b></p> |
|---|---|

|   |   |
|---|---|
|  | <p><b>Do not throw away the waste oil of the compressor, because it contains refrigerant in solution.</b></p> <p><b>The waste oil must be returned to the manufacturer.</b></p> |
|---|---|

Unless otherwise specified, the operations described below may be carried out only by a trained maintenance operator.

### 9.1 General requirements

Units have been designed for continuous operation, providing that they are subjected to regular maintenance, within the limits specified in this manual. Each unit must be serviced according to the programme by the User/Customer, and must be inspected at regular intervals by the personnel of one authorised Service Centers.

It is the responsibility of the User to meet these maintenance requirements and/or to enter into an agreement with one of authorised Service Centers, so as to properly safeguard the operation of the appliance.

During the warranty period, in case of damage or failures caused by improper maintenance, manufacturer will not refund the costs incurred to repair the appliance in its original state.

The provisions of this section apply only to standard units; according to the order requirements, other documentation may be added, concerning any modifications or supplementary accessories.

### 9.2 Planned maintenance

Maintenance inspections must be carried out according to the program below, by a qualified person.

As a general rule, units cannot be repaired directly by the user, who shall not try to service or repair any failures or anomalies identified during daily inspections. If you are in doubt, please contact authorised Service Centre.

| Operations   | Daily | Weekly | Monthly | Beginning of season | End of season |
|--|-------|--------|---------|---------------------|---------------|
| Check the temperature of the leaving fluid                   | ●     |        |         |                     |               |
| Check the pressure drops in the heat exchanger               |       | ●      |         |                     |               |
| Check for electric absorption                                |       | ●      |         |                     |               |
| Check suction pressure and temperature                       |       | ●      |         |                     |               |
| Check delivery pressure and temperature                      |       | ●      |         |                     |               |
| Check the oil level in the compressor                        |       | ●      |         |                     |               |
| Check that there are no gas bubbles in the liquid line       |       | ●      |         |                     |               |
| Check the operation of the oil heaters                       |       |        | ●       |                     |               |
| Check the remote control switches                            |       |        | ●       |                     |               |
| Check the operation of the LP pressure switch                |       |        |         | ●                   |               |
| Check the operation of the HP pressure switch                |       |        |         | ●                   |               |
| Check the insulation of the heat exchanger                   |       |        |         | ●                   |               |
| Check that terminals are tightened                           |       |        |         | ●                   |               |
| Check that the terminals' screws are tightened               |       |        |         | ●                   |               |
| Clean the exterior of the unit with water and soap           |       |        |         | ●                   |               |
| Check the density of the antifreeze (if any)                 |       |        |         | ●                   | ●             |
| Check the operation of differential pressure / flow switches |       |        |         | ●                   |               |
| Check the operation of the solenoid valve                    |       |        |         | ●                   | ●             |

## 9 - Maintenance (continued)

### 9.3 Refrigerant charge

Do not inject refrigerant liquid into the LP side of the circuit. Be very careful, and charge the circuit properly. If the charge is insufficient, the efficiency of the unit will be lower than expected. (In the worst of cases the LP transducer may stop the unit.)

In the presence of an excess charge, the condensing pressure will rise (in the worst of cases, the HP pressure switch may be activated, resulting in the stop of the equipment), and the consumption will increase as well.

It is strictly forbidden to use the compressor as a vacuum pump to drain the plant.

Fill the refrigeration circuit after it has been drained for maintenance purposes (leaks, replacement of the compressor etc.). The amount of the charge is indicated on the plate affixed to the unit.

Before refilling, it is important to drain and de-hydrate the circuit, thus obtaining a minimum abs. pressure value of 50 Pa.

Inject the refrigerant fluid before removing the vacuum, then fill the circuit up to 90% of the total gas requirement (in liquid form). The appliance must be filled through the filling valve on the liquid line, on the outlet side of the condenser.

It is recommended to connect the refrigerant cylinder to the filling valve on the liquid line, and to arrange it in such a way as to inject only liquid refrigerant.

### 9.4 Compressor

Compressors are delivered with the necessary charge of lubricating oil. During normal operation, this charge is sufficient for the whole life of the unit, providing that the efficiency of the refrigeration circuit is satisfactory and if it has not been overhauled.

If the compressor needs to be replaced (following a mechanical failure or if burnt), contact one of authorised Service Centers.

Compressors use polyester oil. During maintenance operations on the compressor, or if you have to open the refrigerant circuit in any point, remember that this type of oil is highly hygroscopic, and accordingly it is important that it is not left exposed to the weather for prolonged periods, as this would require the replacement of the oil.

### 9.5 Condenser

Check at regular intervals that the water side of the heat exchanger is perfectly clean. To do this, measure the pressure drop, water side (see Section 8) or measure the temperature of the liquid leaving and entering the heat exchanger, and compare it to the condensing temperature.

To obtain an effective heat exchange, the difference between the temperature of the leaving water and the saturated condensing temperature must be in the 3 - 5°C range. A greater difference would indicate a low efficiency of the heat exchanger (i.e. the heat exchanger is dirty).

In this case, the heat exchanger must be subjected to chemical cleaning, an operation that shall be carried out by authorised engineers.

For other maintenance operations (extraordinary overhauling, replacement of the heat exchanger etc.), contact an authorised Service Centre.

### 9.6 Dehydrating filter

The refrigeration circuits are provided with dehydrating filters.

The filter clogging is marked by the presence of air bubbles in the sight glass, or by the difference between the temperatures measured downstream from and upstream of the drying filter. If, once the cartridge has been cleaned, there are still some air bubbles, the appliance has lost a part of the refrigerant charge in one or more points, that must be identified and serviced.

### 9.7 Sight glass

The sight glass is used for inspecting the refrigerant flow and the humidity % of the refrigerant. The presence of bubbles indicates that the dehydrating filter is clogged or the charge insufficient.

A colour indicator is positioned inside the sight glass. If you compare the colour of the indicator to the scale on the ring of the sight glass, you can calculate the percentage of humidity of the refrigerant. If it is excessive, replace the filter's cartridge, operate the appliance for 1 day and then check the humidity % again. When the humidity % is within the pre-determined range, no other operations are required. If the humidity % is still too high, replace the dehydrating filter again, start the unit and operate it for another day.

## 9 - Maintenance (continued)

### 9.8 Mechanical expansion valve

The circuit of the unit is equipped with a mechanical expansion valve, with external equalizer

The valve is factory calibrated for an overheating of 5 °C.

Procedure to check for overheating:

- Measure the suction pressure with the pressure gauges on the board of the unit or using a pressure gauge connected to the service valve on the suction side.
- From the pressure gauge's temperature scale, measure the saturated suction temperature (Tsa) which corresponds to the pressure value.
- Using a contact pressure gauge affixed to the outlet fitting of the gas of the evaporator, measure the actual temperature (Tse).

Overheating calculation (S):

$$S = Tse - Tsa$$

Overheating is regulated through the expansion valve.

Make the adjusting screw follow a complete turn, and operate the appliance for five minutes.

Check again and, if necessary, repeat the regulation.

If the expansion valve cannot be regulated, it is probably broken, and shall be replaced. The replacement must be carried out by a Service Centre.

### 9.9 Evaporator

Check at regular intervals that the water side of the heat exchanger is perfectly clean. To do this, measure the pressure drop, water side (see Section 8) or measure the temperature of the liquid leaving and entering the heat exchanger, and compare it to the evaporation temperature.

To obtain an effective heat exchange, the difference between the temperature of the leaving water and the saturated evaporating temperature must be in the 2 - 4°C range. A greater difference would indicate a low efficiency of the heat exchanger (i.e. the heat exchanger is dirty).

In this case, the heat exchanger must be subjected to chemical cleaning, an operation that shall be carried out by authorised engineers.

For other maintenance operations (extraordinary overhauling, replacement of the heat exchanger etc.), contact an authorised Service Centre.

## 10 - Troubleshooting

The table below lists the anomalies of operation of the unit, the relevant causes and the corrective measures. For anomalies of any other type or not listed, contact one of authorised Service Centre for technical assistance.

| Anomaly  | Cause  | Operation  |
|--|--|--|
| <b>The unit continues to work, but without cooling</b> | Insufficient charge of refrigerant.                      | Refill.  |
|  | The dehydrating filter is clogged.                       | Replace.   |
| <b>Ice on the suction line</b>                         | Wrong calibration of overheating.                        | Increase overheating.  |
|  |  | Check the charge.  |
| <b>Excessive noise</b>                                 | Vibration of lines.                                      | Check the clamping brackets, if any.   |
|  | Whistler emitted by the thermostatic expansion valve.    | Refill.  |
|  |  | Check the dehydrating filter.  |
|  | Noisy compressor.  | Seized bearings; replace the compressor.   |
| Check that the compressor's locknuts are tightened.    |  |  |
| <b>Low oil level in the compressor</b>                 | One or more gas or oil leaks in the circuit.             | Identify and remove leaks.   |
|  | Mechanical failure of the compressor.                    | Request the intervention of a Service Centre.  |
|  | Anomaly of the oil heater of the compressor's base.      | Check the electric circuit and the resistor of the heater of the motor base, and replace defective components.                             |
| <b>One or both compressors are not working</b>         | Breaking of the electric circuit.                        | Check the electric circuit and detect any ground dispersions and short circuits. Check fuses.  |
|  | Intervention of the HP pressure switch.                  | Reset the pressure switch and the control panel and restart the appliance. Identify and remove the cause that enabled the pressure switch. |
|  | The fuse of the control circuit is broken.               | Check for ground dispersions and short circuits. Replace fuses.  |
|  | Loosened terminals.                                      | Check and tighten.   |
|  | Halt caused by thermal overload of the electric circuit. | Check the operation of check and safety devices. Identify and remove the cause.  |
|  | Wrong wiring.  | Check wiring of check and safety devices.  |
|  | The line voltage is too low.                             | Check voltage. If problems regard the system, solve them. If they are caused by the distribution network, inform the Energy Distributor.   |
|  | Short-circuit of the compressor's motor.                 | Check the continuity of the winding.   |
| Seized compressor.                                     | Replace the compressor.                                  |  |
| <b>Activation of the LP alarm, stop of the unit</b>    | Gas leak.  | Identify and remove the leak.  |
|  | Insufficient charge.                                     | Refill.  |
|  | Failure of the pressure switch.                          | Replace the pressure switch.   |
|  | The pump of the evaporator is stopped.                   | Check cables and motor. If defective, repair or replace.   |
| <b>Activation of the HP alarm, stop of the unit</b>    | Failure of the pressure switch.                          | Check the operation of the pressure switch, replace it if defective.   |
|  | The delivery valve is partially closed.                  | Open the valve and replace it, if faulty.  |
|  | Substances with condensable gases in the circuit.        | Drain the circuit.   |
|  | The pump of the condenser is stopped.                    | Check cables and motor. If defective, repair or replace.   |
| <b>The liquid line is too hot</b>                      | Insufficient charge.                                     | Identify and remove the cause of the loss of charge and refill.  |
| <b>Frosting of the liquid line</b>                     | The valve of the liquid line is partially closed.        | Check that valves are open.  |
|  | The liquid filter is clogged.                            | Replace the cartridge or the filter.   |

## 11 - Spare Parts

### 11.1 Spare part list

The table below shows the list of spare parts recommended during the first two years of operation.

| Component                     | Number |
|-------------------------------|--------|
| Pump                          | 1      |
| Differential pressure switch  | 1      |
| High pressure transducer      | 1      |
| Low pressure transducer       | 1      |
| Expansion valve               | 1      |
| Gas filter                    | 1      |
| 4 way valve                   | 1      |
| Electronic main board         | 1      |
| Auxiliary circuit transformer | 1      |
| Compressor contactor          | 2      |
| Pump contactor                | 1      |
| Water sensor                  | 4      |
| Auxiliary contact             | 4      |
| Driver EEV                    | 1      |
| Fuses                         | 4      |

### 11.2 Oil for compressors

The compressors are lubricated with polyester oil (P.O.E.).

### 11.3 Wiring diagrams

The wiring diagrams are installed inside the doors of the electrical panels of the unit. Any request for wiring diagrams shall be forwarded to manufacturer's Service Centre.

## 12 - Dismantling, Demolition and Scrapping



**During the draining of the refrigeration circuits, do not let the refrigerant overflow in the surrounding atmosphere.**

**The circuit must be drained using suitable recovery equipment.**



**Do not disperse the waste oil of the compressors in the environment, since it contains some dissolved refrigerant.**

**For the disposal, contact the competent authority for information.**

Unless otherwise specified, the maintenance operations listed below may be carried out by any trained maintenance operator.

### 12.1 Generalities

Open each line that supplies the unit, including the ones of control circuits. Make sure that all disconnecting switches are secured in the off position. The power cables can be disconnected and disassembled. Refer to Chapter 4 for the position of connection points.

Remove all the refrigerant from the refrigeration circuits of the unit and store it in suitable containers, using a recovery unit. If its characteristics have remained the same, the refrigerant can be used again. Contact the competent authority to obtain information about disposal. In **NO** event shall the refrigerant be discharged into the atmosphere. The oil in each refrigeration circuit must be drained and collected into a suitable container; then it shall be disposed of in conformity with local regulations that apply to the disposal of waste lubricants. Any oil spillage must be recovered and disposed of in like manner.

Isolate the unit's heat exchangers from the external hydraulic circuits and drain the heat exchange sections of the plant.



**If no shutoff valves have been provided, it may be necessary to drain the whole plant.**

**If a glycoled solution or a similar fluid has been used in the hydraulic circuits, or if chemical additives have been added to the circulating water, the circulating fluid MUST be drained in a proper way.**

**For NO reason shall a circuit containing glycoled water or a similar solution be discharged directly into the drains or surface waters.**

After draining operations, the piping of the hydraulic networks can be disconnected and disassembled.

Once they have been disconnected as specified, the packaged units can be disassembled in a single piece. First of all, disassemble the anchoring screws and then lift the unit from the position of installation, and hook it to the lifting points provided, using suitable lifting equipment.

To this end, refer to Chapter 4 for the installation of these appliances, to Chapter 8 for their weights and Chapter 3 for handling.

The units that, once disconnected, cannot be removed in a single piece, must be dismantled on site; in this case, be very careful with the weight and handling of every single component.

It is always advisable to dismantle the units following the installation steps, but in reverse.



**Some residues of oil, glycoled water or similar solutions may remain in certain parts of the unit. These residues must be recovered and disposed of according to the procedures specified above.**

It is very important to ensure that, while a component of the unit is being removed, all the others are properly supported.



**Use only lifting means of adequate capacity.**

Once disassembled, the components of the unit can be disposed of in conformity with current regulations.

## **BUONE NORME DI MANUTENZIONE DEI DISPOSITIVI DI SICUREZZA MONTATI SUL GRUPPO FRIGORIFERO**

Gentile Cliente,

Le ricordiamo alcune indicazioni circa le modalità di manutenzione dei dispositivi di sicurezza montati sul gruppo frigorifero da Lei acquistato.

I dispositivi di sicurezza montati sul gruppo sono stati verificati dal COSTRUTTORE a norma di legge.

È opportuno che l'utente provveda periodicamente (è consigliato ogni anno) a far verificare da personale qualificato la taratura ed il corretto intervento dei dispositivi di sicurezza montati sul gruppo.

In particolare la taratura della/e valvole di sicurezza dovrebbe essere verificata al banco intercettando opportunamente il circuito e/o il refrigerante e registrando l'avvenuta verifica sulla scheda di manutenzione del gruppo frigorifero (a disposizione dei tecnici CE/PED che eventualmente ne prenderanno visione).

L'utente avrà cura di conservare efficienti ed in buono stato l'evaporatore ed i suoi accessori e provvederà ad eventuali sostituzioni degli stessi con altri di tipo analogo.

In caso di sostituzione, la valvola di sicurezza e i pressostati di alta pressione dovranno avere caratteristiche equivalenti a quelle fornite e rilasciate con certificato CE/PED.

Si consiglia in occasione della verifica delle valvole di sicurezza di far controllare il corretto intervento dei pressostati di alta pressione.

Per informazioni circa le modalità operative, la strumentazione e la scelta di personale qualificato, è possibile contattare IL COSTRUTTORE.

### **IMPORTANT NOTICE – Maintenance instructions**

Please read carefully the following instructions for the maintenance of safety devices fitted on this refrigeration machine.

All safety devices fitted on the machine by MANUFACTURE have been checked and tested in accordance with European Regulations.

The machine has been designed to operate continuously provided it is regularly maintained and operated within the limitations given in the "Installation, Commissioning, Operation and Maintenance Manual". The unit should be maintained in accordance with the schedule by the operator/customer, backed up regular service and maintenance visit by an authorised service Centre.

It is the responsibility of the owner to provide for these regular maintenance requirements by a competent person. If in any doubt contact your local Service Centre.

In particular, all safety valves where fitted and safety pressure switches should be tested and calibrated. Where necessary test certificate provided by a certified authority must be retained as a record together with the Maintenance Log.

Date: 18/01/2012

**Nazareno Mantovani**

Quality / Service Director



*As part of our ongoing product improvement programme, our products are subject to change without prior notice. Non contractual photos.*

*Dans un souci d'amélioration constante, nos produits peuvent être modifiés sans préavis. Photos non contractuelles.*

*In dem Bemühen um ständige Verbesserung können unsere Erzeugnisse ohne vorherige Ankündigung geändert werden. Fotos nicht vertraglich bindend.*

*A causa della politica di continua migliona posta in atto dal costruttore, questi prodotti sono soggetti a modifiche senza alcun obbligo di preavviso. Le foto pubblicate non danno luogo ad alcun vincolo contrattuale.*

*Con objeto de mejorar constantemente, nuestros productos pueden ser modificados sin previo aviso. Fotos no contractuales.*

